

# Common Parts

**1** MAXI GRID FIXTURE PANEL (GPWFP)

FIXTURE PANELS ARE USED AS END SUPPORT.

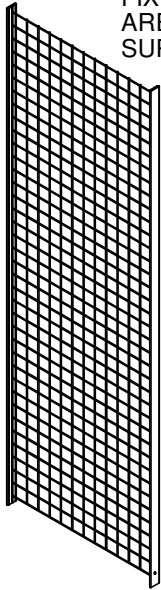

**2** MAXI GRID WIRE GRID SHELF WITH (GPWGS)

SHELF CAN BE USED ANYWHERE.

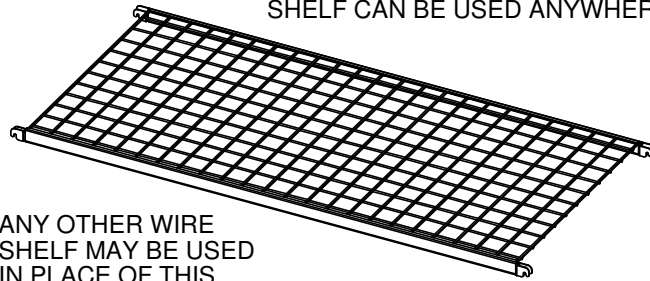

ANY OTHER WIRE SHELF MAY BE USED IN PLACE OF THIS COMPONENT

MAXI GRID HEAVY-DUTY WIRE TOP SHELF WITH LIP (GPHDWTS)

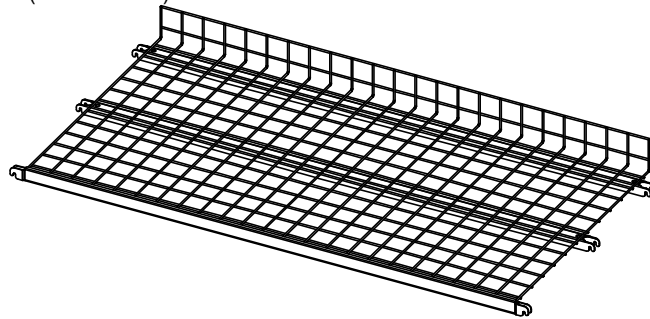

**3** MAXI GRID REINFORCEMENT BAR (GPRB)

REINFORCEMENT BARS ARE USED TO SUPPORT WOOD SHELVES.

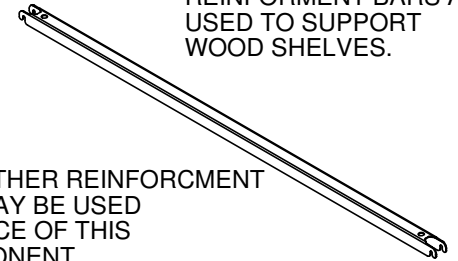

ANY OTHER REINFORCEMENT BAR MAY BE USED IN PLACE OF THIS COMPONENT  
EXAMPLE: GPBRC & GPBRL

**4** MAXI GRID FRONT KICKPLATE (GPGKB) (OPTIONAL)

PROTECTS ITEMS FROM SLIDING UNDER UNIT.



**5** MAXI GRID WOOD SHELF (GPWS)

WOOD SHELVES SIT ON REINFORCEMENT BARS.

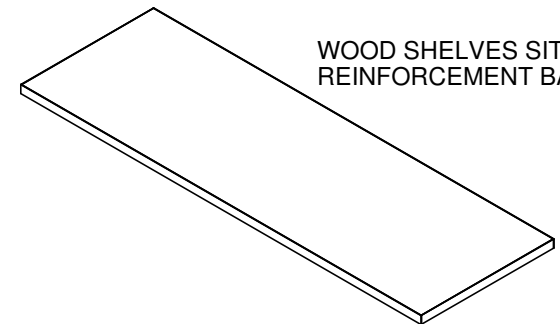

**6** MAXI GRID ANTI-SWAY BRACES (GPASTBA)

ANTI SWAY BRACES ARE AT THE BACK FOR SUPPORT, AND REQUIRED TO STABILIZE SYSTEM. COMES IN PAIRS.

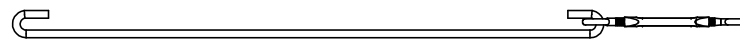

**madix**  
**ASY-80034922**

P.O. BOX 729 TERRELL, TEXAS 75160  
214-515-5400 / 800-776-2349

PAGE 1 OF 13    REV. 00  
SAM    ECM # 500000013495

# INSTRUCTION SET A

## THREE PEOPLE ARE NEEDED TO INSTALL SYSTEM

**2A** INSTALL REBAR (**2A.1**).  
LOWER OTHER SIDE OF REBAR. (**2A.2**)

**1** STAND BOTH FIXTURE PANELS UP 48 INCHES APART. MAKE SURE HORIZONTAL WIRES ARE FACING THE SAME DIRECTION ON BOTH FIXTURE PANELS.

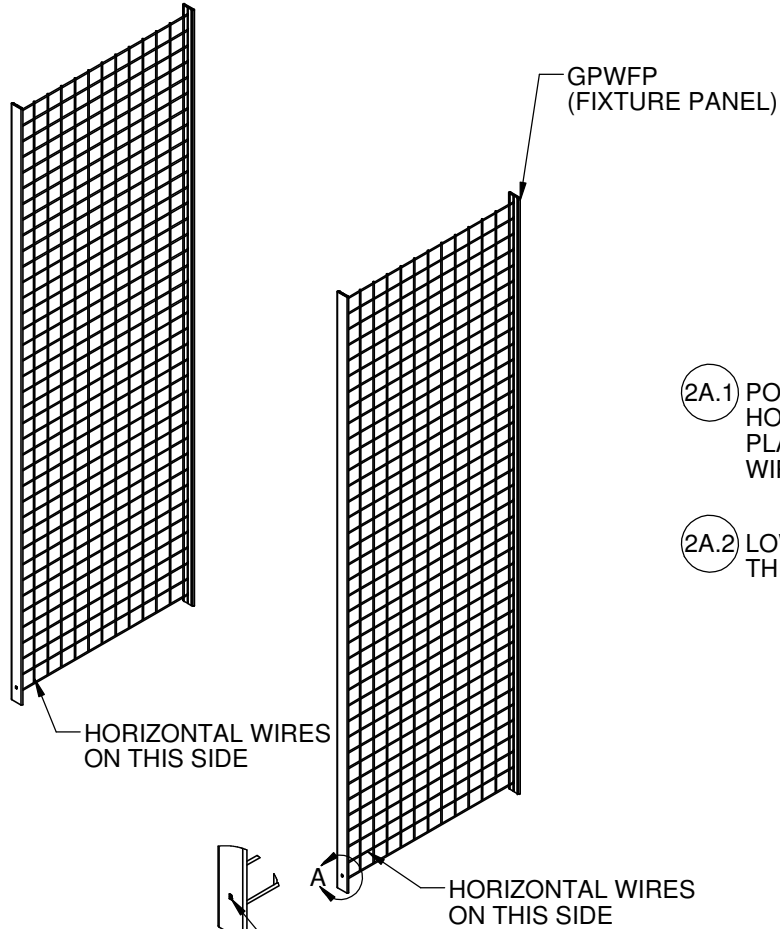

**2A.1** POSITION ONE SIDE AT THE SECOND HORIZONTAL WIRE FROM THE BOTTOM. PLACE PRONGS SO THE FIRST VERICAL WIRE FROM THE BACK IS BETWEEN THEM

**2A.2** LOWER THE OTHER SIDE OF THE REBAR UNTIL IT IS IN PLACE

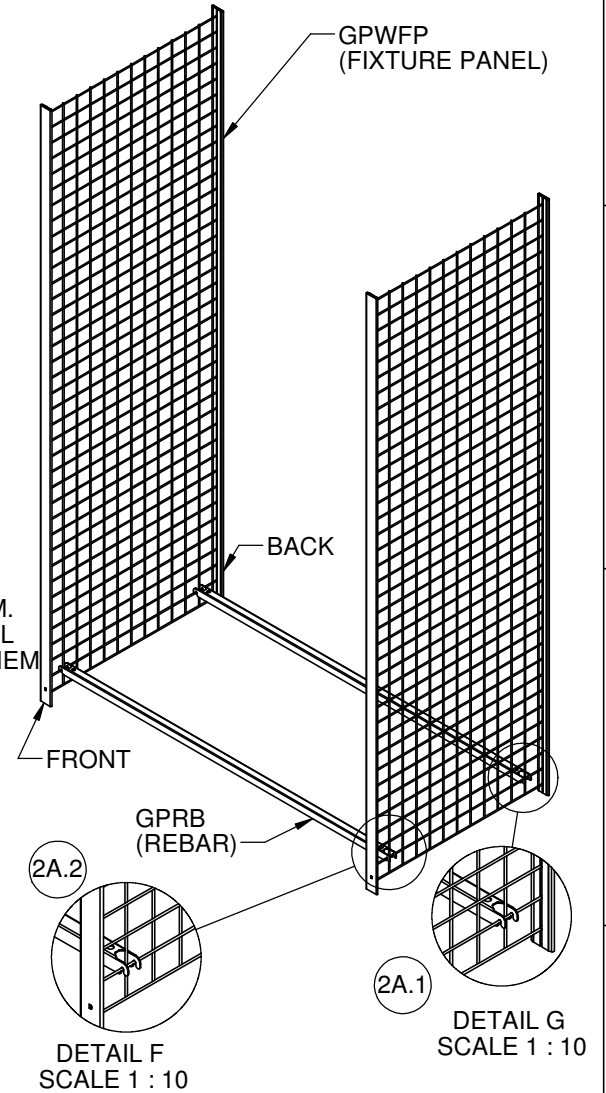

DETAIL A  
SCALE 1 : 8  
"B" SHOULD BE AT BOTTOM

ONE PERSON HOLDS EACH FIXTURE PANEL WHILE THIRD PERSON INSTALLS REBAR, KICKPLATE, OR SHELF. THIS IS REQUIRED UNTIL ANTI-SWAY BRACES ARE INSTALLED (SEE SHEET 4)

**madix**  
**ASY-80034922**

P.O. BOX 729 TERRELL, TEXAS 75160  
214-515-5400 / 800-776-2349

PAGE 2 OF 13 REV. 00

SAM

ECM # 500000013495

**2B** INSTALL FRONT KICKPLATE (2B.1)  
LOWER OPPOSITE SIDE OF KICKPLATE. (2B.2)  
SLIDE KICKPLATE TOWARDS OPPOSITE SIDE  
SO THAT THE PRONGS ARE ALSO ABOVE THE  
WIRES. LOWER PRONGS AND LOCK ONTO WIRE.(2B.3)  
(OPTIONAL)

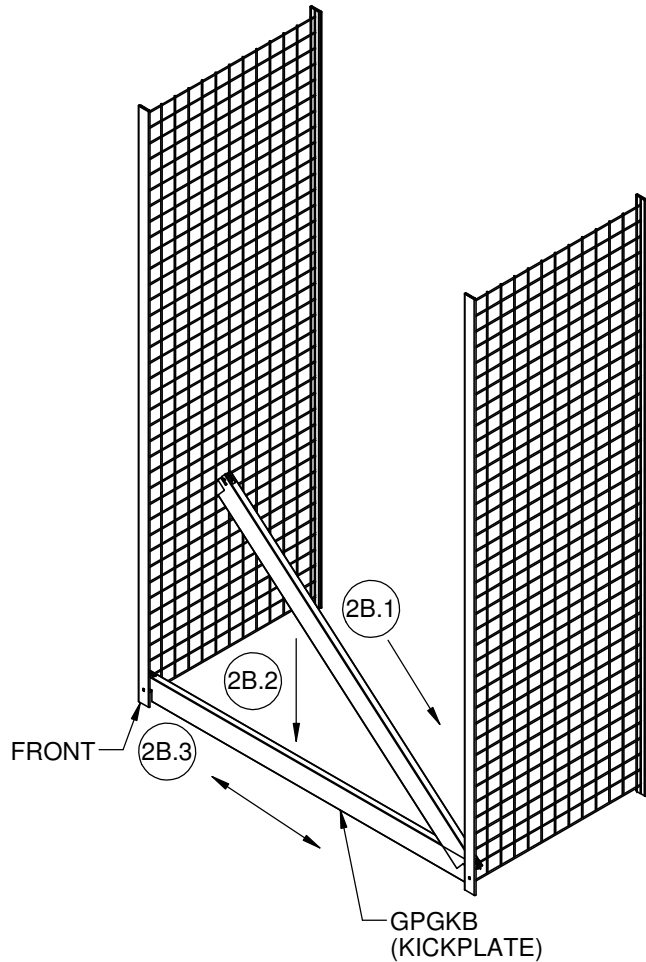

(2B.1) ANGLE KICKPLATE, AND  
SLIDE OVER HORIZONTAL  
WIRE  
(2B.2) ROTATE OPPOSITE SIDE  
DOWN  
(2B.3) SLIDE TOWARD OPPOSITE  
PANEL UNTIL LOCKED IN  
PLACE  
(OPTIONAL)

**3A** INSTALL TWO REBARS ON THE TOP.  
(FOLLOW STEP 2A)

(3A.1) POSITION ONE SIDE AT THE SECOND  
HORIZONTAL WIRE FROM THE BOTTOM.  
PLACE PRONGS SO THE FIRST VERICAL  
WIRE FROM THE BACK IS BETWEEN THEM

(3A.2) LOWER THE OTHER SIDE OF  
THE REBAR UNTIL IT IS IN PLACE

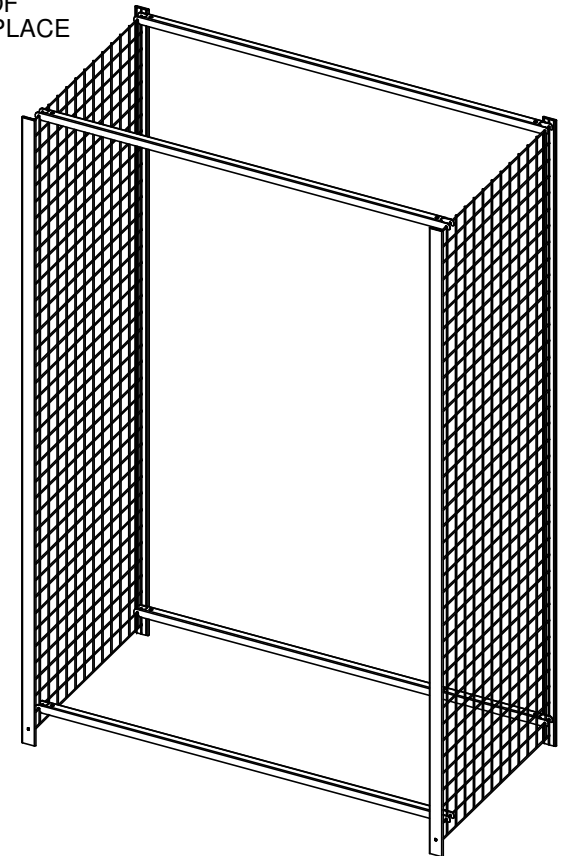

**madix**  
**ASY-80034922**

P.O. BOX 729 TERRELL, TEXAS 75160  
214-515-5400 / 800-776-2349

PAGE 3 OF 13 REV. 00

SAM ECM # 500000013495

3B

A WIRE GRID SHELF (GPHDWTS) SHOWN CAN BE USED TO STABILIZE THE TOP OF THE WIRE FIXTURE PANELS. INSTALL BY: HOOK BOTH PRONGS OF ONE SIDE OF THE TOP SHELF ON THE HORIZONTAL WIRE. THEN HOOK OTHER SIDE UNTIL SHELF IS INSTALLED.

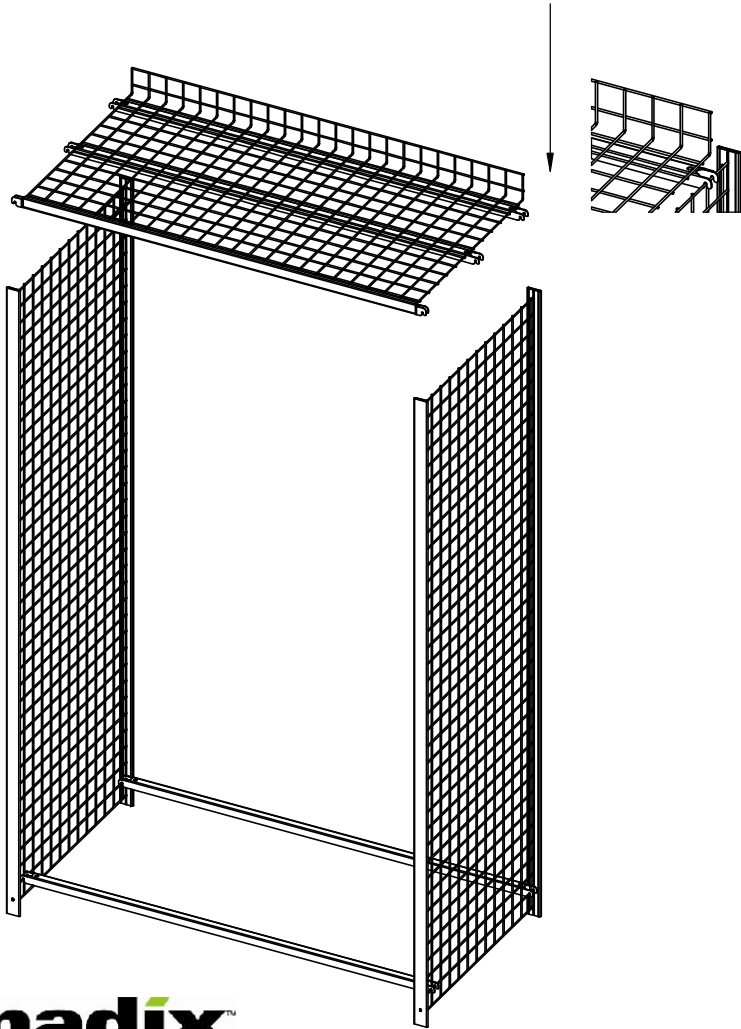

4

UNSCREW ANTI-SWAY BRACE SO IT IS FLUSH. HOOK ONE SIDE OF THE BRACE OVER ANY WIRE IN THE TOP THIRD SECTION OF THE GABLE. HOOK THE OTHER SIDE OF THE BRACE TO ANY WIRE IN THE BOTTOM THIRD SECTION OF OPPOSITE GABLE. REPEAT TO INSTALL SECOND ANTI-SWAY BRACE. BRACES SHOULD FORM AN X ON THE BACK OF THE UNIT. TIGHTEN TURN BUCKLES ON BRACES TO SQUARE UNIT. **DO NOT OVER-TIGHTEN TURNBUCKLE!**

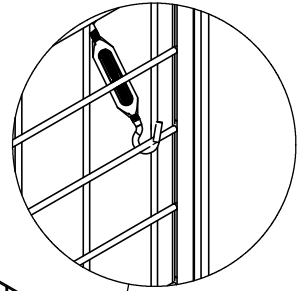
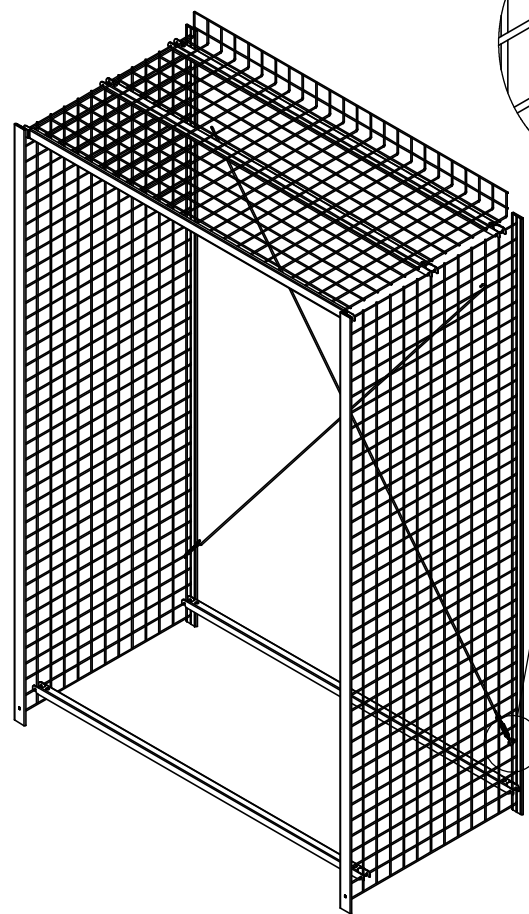

DETAIL C  
SCALE 1 : 4



**madix**  
**ASY-80034922**

P.O. BOX 729 TERRELL, TEXAS 75160  
214-515-5400 / 800-776-2349

PAGE 4 OF 13 REV. 00

SAM ECM # 500000013495

5 TO INSTALL WOOD SHELF (5.1) SLIDE WOOD SHELF AND (5.2) LOWER SHELF ONTO KICKPLATE AND REBAR TO INSTALL ADDITIONAL WOOD SHELVES SEE SHEET 4.

5.1 SLIDE WOOD SHELF INTO FRAME AT AN ANGLE

5.2 LOWER IT ONTO THE TOP OF THE KICKPLATE AND REBAR.

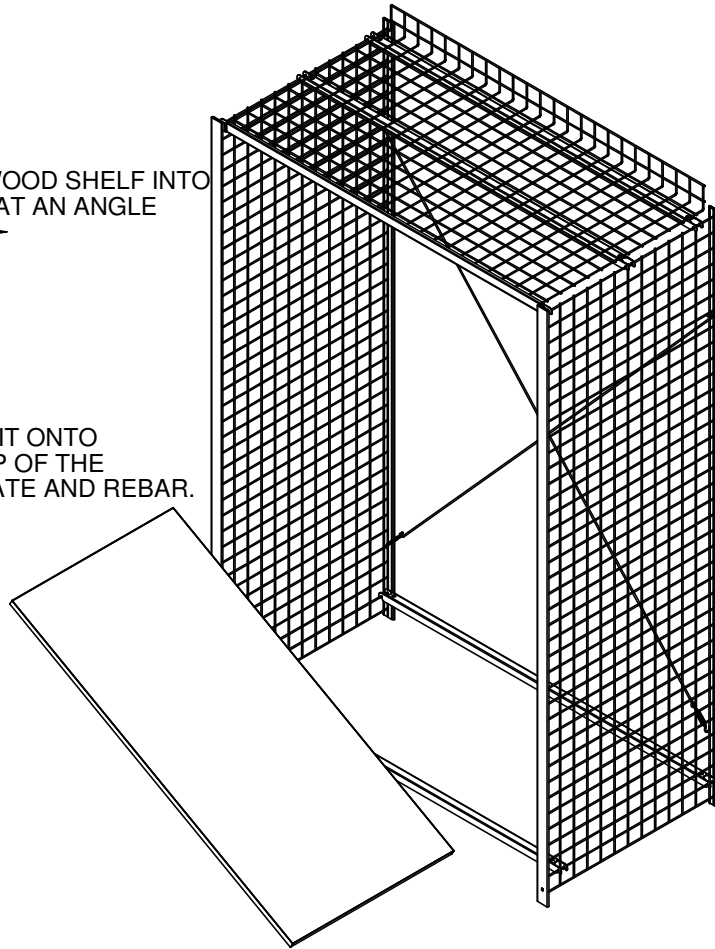

6 TO INSTALL A WOOD SHELF, ANYWHERE IN THE UNIT, YOU MUST FIRST INSTALL TWO REBARS. HOLD BAR AT AN ANGLE. SLIDE BAR INTO THE FRAME OF THE UNIT, WITH ONE SIDE AT THE DESIRED SHELF HEIGHT. DO NOT LOCK! VERTICAL WIRE SHOULD BE BETWEEN PRONGS. SLIDE PRONGS PASSED HORIZONTAL WIRES. LOWER THE OPPOSITE SIDE OF THE BAR SO THAT THE BAR IS LEVEL. SLIDE BAR BACK INTO PLACE, SO THAT PRONGS ARE OVER THE HORIZONTAL WIRES. LOWER AND LOCK INTO PLACE. REPEAT STEP FOR SECOND REBAR. FOLLOW STEP 5 TO INSTALL WOODEN SHELF.

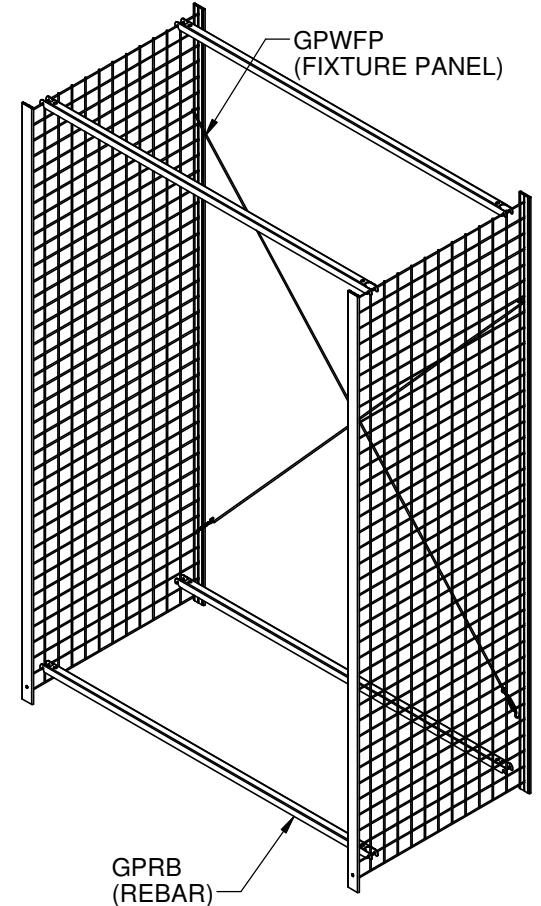



7 TO INSTALL ADDITIONAL TOP SHELVES HOLD SHELF AT AN ANGLE. SLIDE SHELF INTO THE FRAME OF THE UNIT (8.1) SLIDE PRONGS PAST HORIZONTAL WIRES. (8.2) LOWER OPPOSITE SIDE OF SHELF SO THAT THE SHELF IS LEVEL, AND LOWER AND LOCK ON PLACE. (8.3)

7.1 HOLD SHELF AT AN ANGLE, AND SLIDE IT INTO THE FRAME OF THE UNIT, WITH ONE SIDE OF THE SHELF PRONGS AT THE DESIRED HEIGHT. **DO NOT LOCK!!**

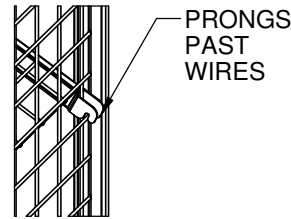
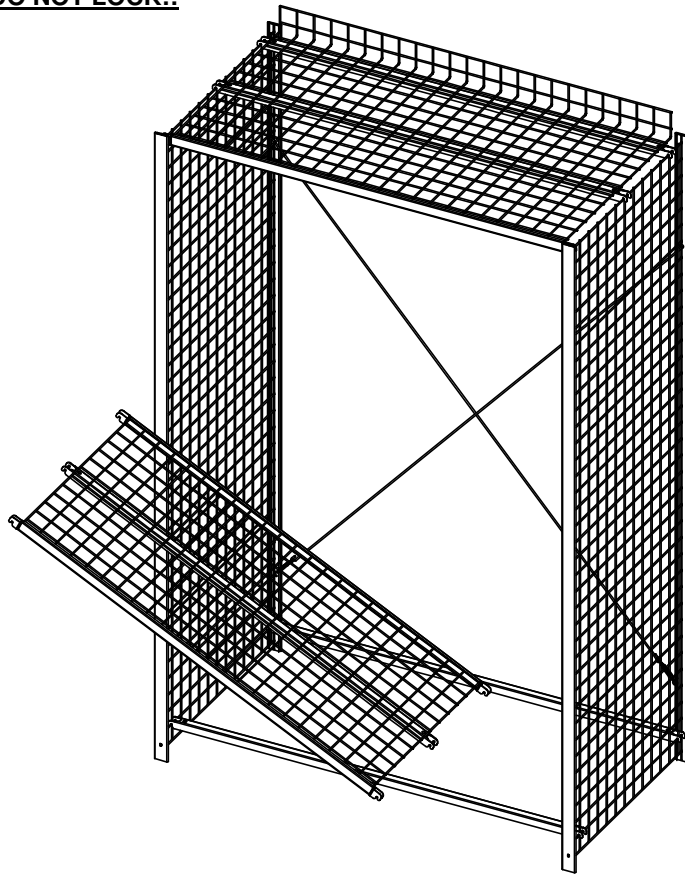

7.2 VERTICAL GABLE WIRES SHOULD BE BETWEEN PRONGS. SLIDE PRONGS PAST HORIZONTAL WIRES.

7.3 LOWER OPPOSITE SIDE OF SHELF SO THAT THE SHELF IS LEVEL. SLIDE SHELF BACK SO THAT THE PRONGS ARE ABOVE THE HORIZONTAL WIRES. LOWER AND LOCK INTO PLACE.

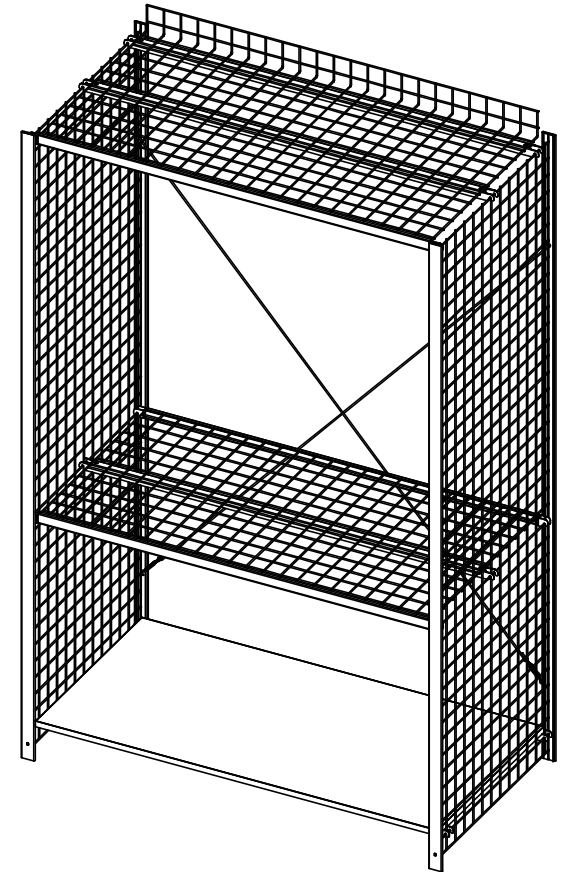

**madix**  
**ASY-80034922**

P.O. BOX 729 TERRELL, TEXAS 75160  
214-515-5400 / 800-776-2349

PAGE 6 OF 13 REV. 00

SAM

ECM # 500000013495

8 TO ADD ADDITIONAL UNITS STAND ANOTHER FIXTURE PANEL 48" FROM THE EXISTING UNIT. MAKE SURE HORIZONTAL WIRES ARE FACING THE SAME DIRECTION AS THE HORIZONTAL WIRES IN THE FIRST UNIT. **NOTE:** ONLY ONE FIXTURE PANEL IS NEEDED TO BUILD THE SECOND UNIT. THE SECOND UNIT WILL SHARE THE OUTWARD FACING FIXTURE PANEL FROM THE FIRST UNIT. USING THIS SHARED FIXTURE PANEL, REPEAT PREVIOUS STEPS TO COMPLETE THE SECOND UNIT.

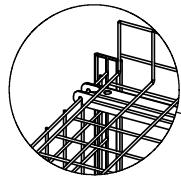

DETAIL D  
SCALE 1 : 10

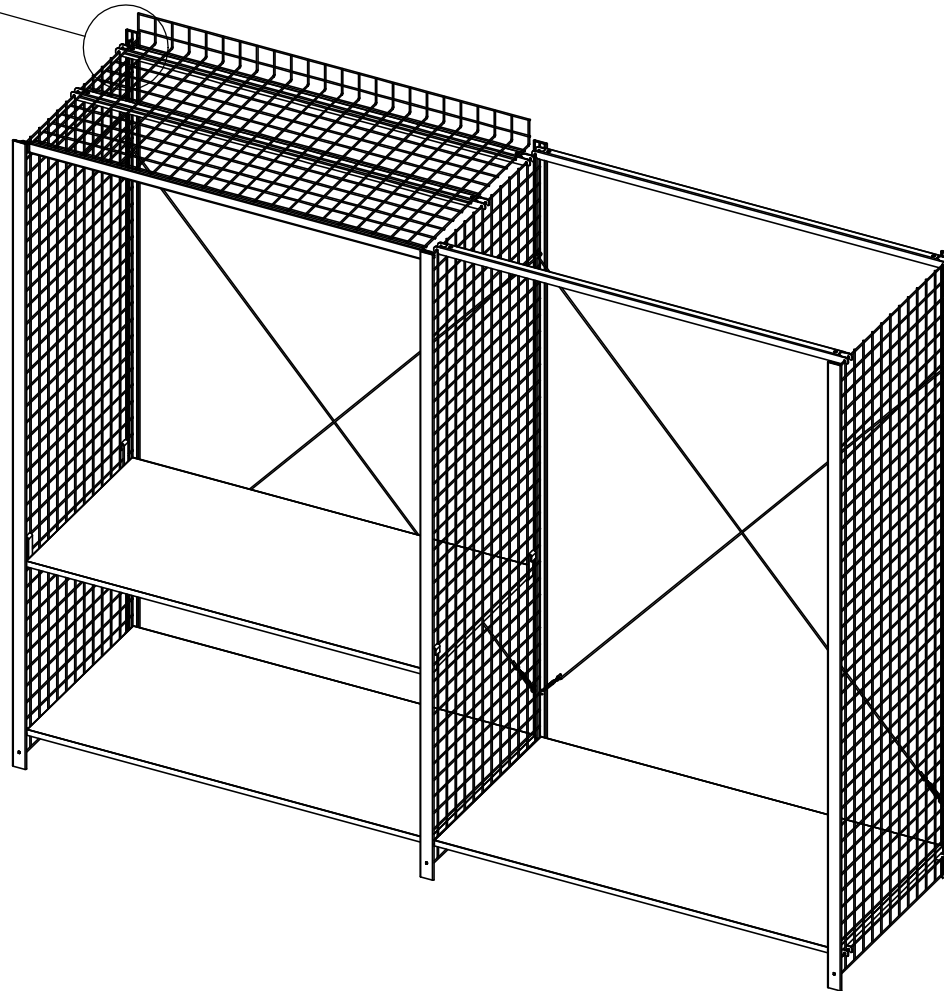

**madix**  
**ASY-80034922**

P.O. BOX 729 TERRELL, TEXAS 75160  
214-515-5400 / 800-776-2349

PAGE 7 OF 13 REV. 00

SAM ECM # 500000013495

9 TO COMPLETE THE SECOND BASIC UNIT, YOU WILL NEED TO ADD A TOP SHELF USING THE SHARED PANEL FIXTURE FROM THE FIRST UNIT REPEAT STEP 6.  
**NOTE:** SEE SHEET 12 FOR ANTI-SWAY BRACE USAGE GUIDE.

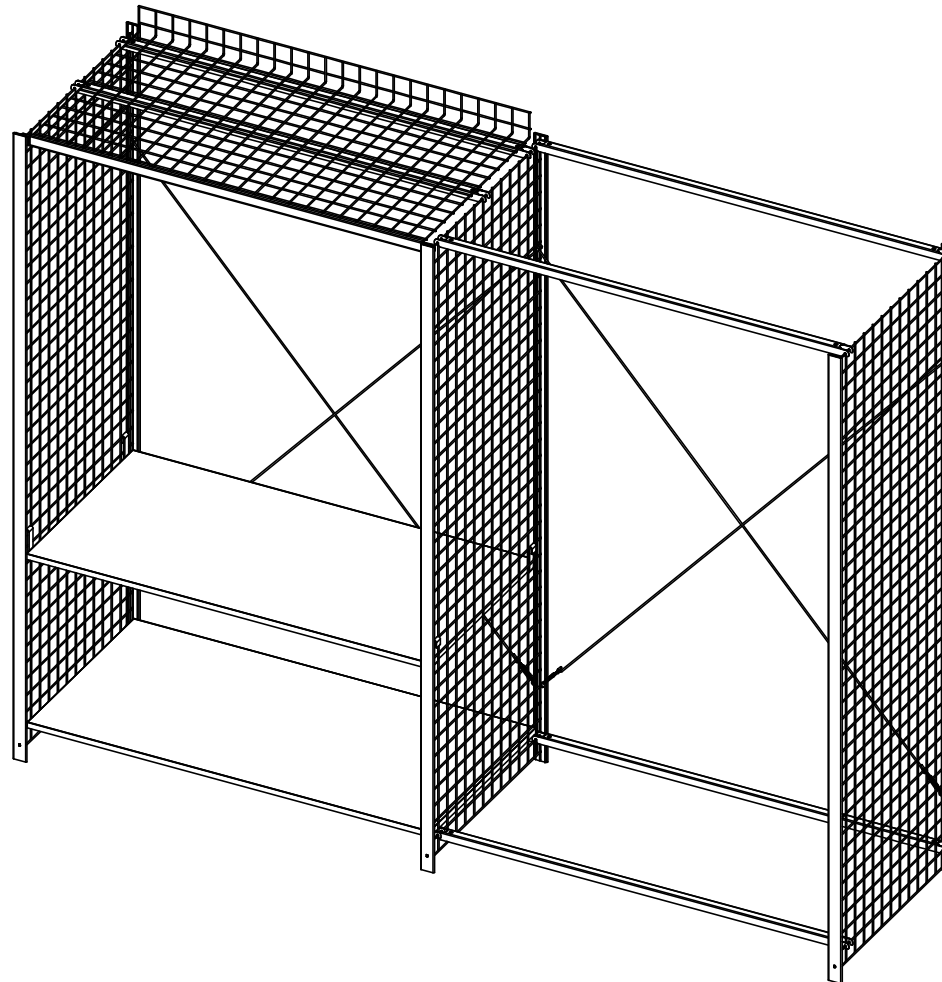



# INSTRUCTION SET B

1 BEFORE STARTING INSTALLATION, YOU MUST FIRST IDENTIFY THE TWO TYPES OF FIXTURE PANELS. THERE ARE **FOOTPLATED PANELS**, AND **NON-FOOTPLATED PANELS**. NOTICE THE "B" ON THE ENDS OF THE PANELS (SEE DETAIL "J"). THIS INFORMATION WILL BE NEEDED IN FUTURE STEPS.

2 STAND ONE NON-FOOTPLATED FIXTURE PANEL UPRIGHT IN THE APPROXIMATE DESIRED LOCATION WITH "B" SIDE ON FLOOR. ALSO NOTICE HORIZONTAL GABLE WIRES. DO THEY SIT BEHIND OR IN FRONT OF VERTICAL WIRES? YOU WILL NEED THIS INFORMATION FOR FUTURE STEPS

## NON-FOOTPLATED FIXTURE PANEL

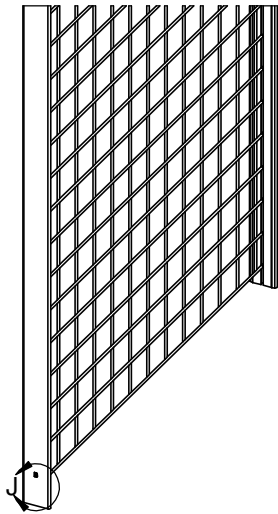

## FOOTPLATED FIXTURE PANEL

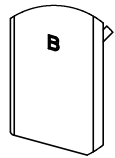
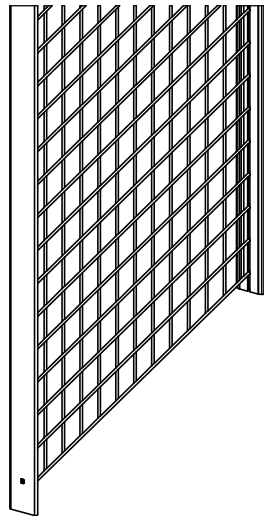

DETAIL J  
SCALE 1 : 3

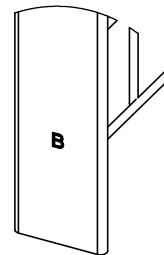

DETAIL K  
SCALE 1 : 3

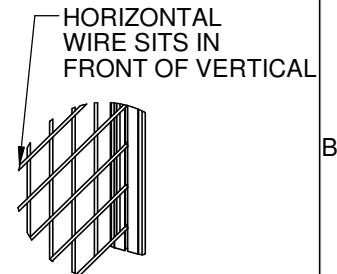
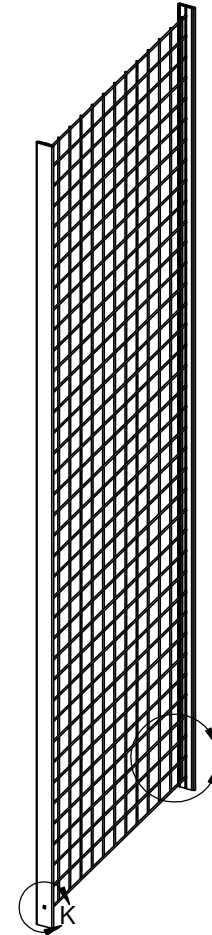

DETAIL L  
SCALE 1 : 8



**madix**  
**ASY-80034922**

P.O. BOX 729 TERRELL, TEXAS 75160  
214-515-5400 / 800-776-2349

PAGE 9 OF 13 REV. 00

SAM ECM # 500000013495

3 STAND A FOOTPLATED FIXTURE PANEL PARALLEL TO THE FIRST FIXTURE PANEL, WITH THE FOOTPLATE ON THE FLOOR. **MAKE SURE THE HORIZONTAL WIRES ARE FACING THE SAME DIRECTION AS THE HORIZONTAL WIRES ON THE FIRST FIXTURE PANEL.**

4 BOLT FOOTPLATE TO THE FLOOR. INSTALL SHELVES AND ACCESSORIES AS USUAL. WHEN ADDING ADDITIONAL UNITS TO THIS FRAME, ROTATE FOOTPLATED AND NON-FOOTPLATED FIXTURE PANELS AS YOU WISH. BUT MAKE SURE THE CORRECT FIXTURE PANEL SIDE IS ON THE FLOOR! ("B" SIDE OR FOOTPLATE SIDE AS DESCRIBED IN PREVIOUS STEPS.

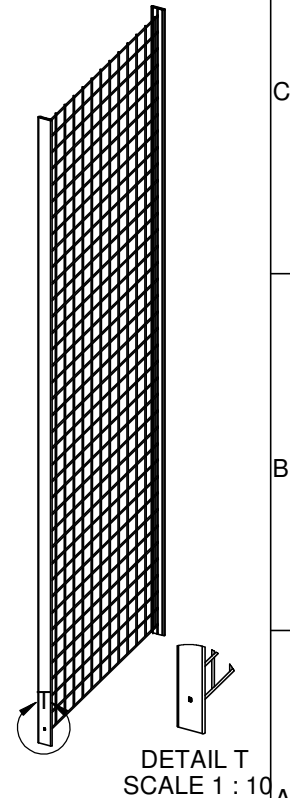
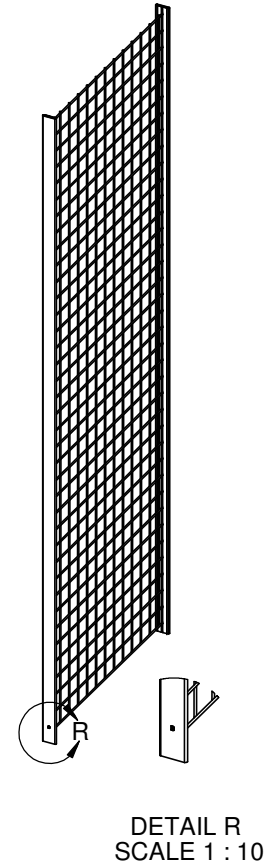
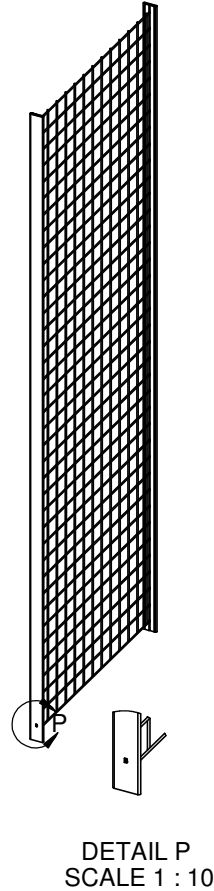
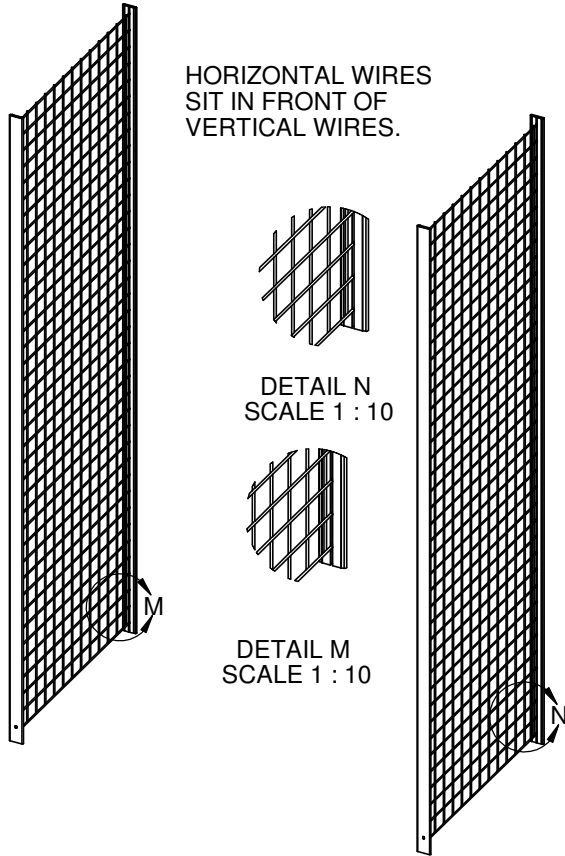

5 IF YOU ARE NOT USING FOOTPLATED FIXTURE PANELS, ENSURE ALL FIXTURE PANELS IN THE RUN HAVE THE "B" SIDE TO THE FLOOR. LINE WIRES AS DIRECTED IN STEP 3. INSTALL SHELVES AND ACCESSORIES AS USUAL.

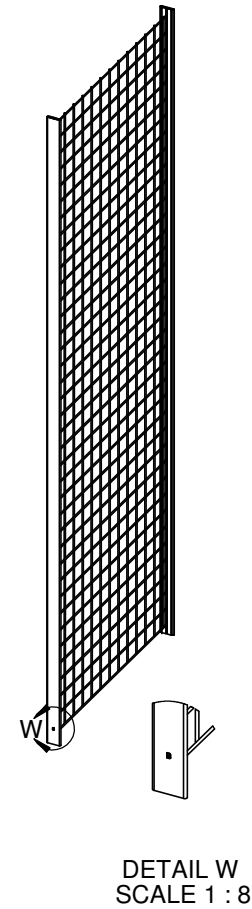
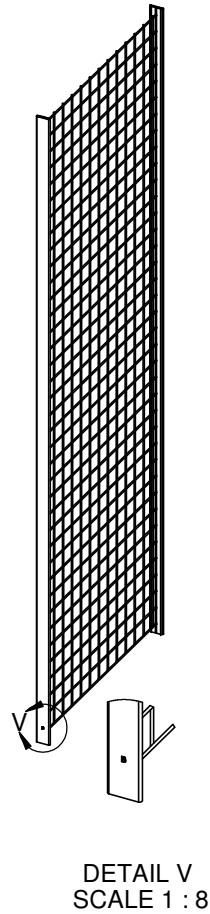
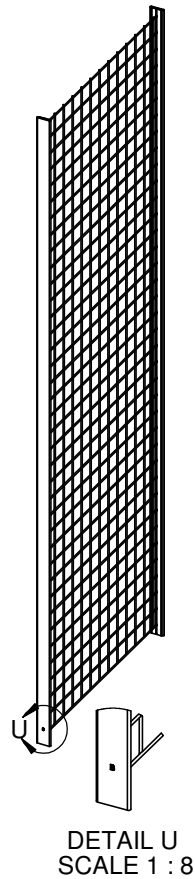

# MAXI GRID ANTI-SWAY BRACES USAGE GUIDE

## GPASTBA(NL)(OPT)

GPASTB - MAXI GRID ANTI-SWAY TURNBUCKLE ASSEMBLY

NL - NOMINAL LENGTH 64" OR 104"

OPT - BLANK = 48"W

36 = SPECIFIED LENGTH FOR 36" SECTION

FIXTURE HEIGHT	FIXTURE WIDTH	
	36"	48"
50"	67	67
62"	67	67
76"	67	67
88"	67	67
100"	67	104
124"	104	104
148"	104	104

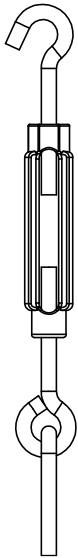

### GPASTBA INSTALLATION

1. STAND FIXTURE PANELS UPRIGHT
2. INSTALL TOP SHELF AND KICKPLATE, IF APPLICABLE, AT TOP AND BOTTOM OF FIXTURE HOOK AB RODS NEAR TOP OF FIXTURE
3. BRING TURNBUCKLES END TO OPPOSITE FIXTURE PANEL. TIGHTEN TURNBUCKLE END JUST ENOUGH TO HOLD FIXTURE UPRIGHT (THE UNIT IS NOW SELF STANDING).
4. INSTALL REMAINING FIXTURE COMPONENTS (SHELVES, SLATWALL, ETC.).
5. FULLY TIGHTEN GPASTBA'S WHILE CHECKING WITH LEVEL TO ENSURE FIXTURE PANELS ARE PLUMB.

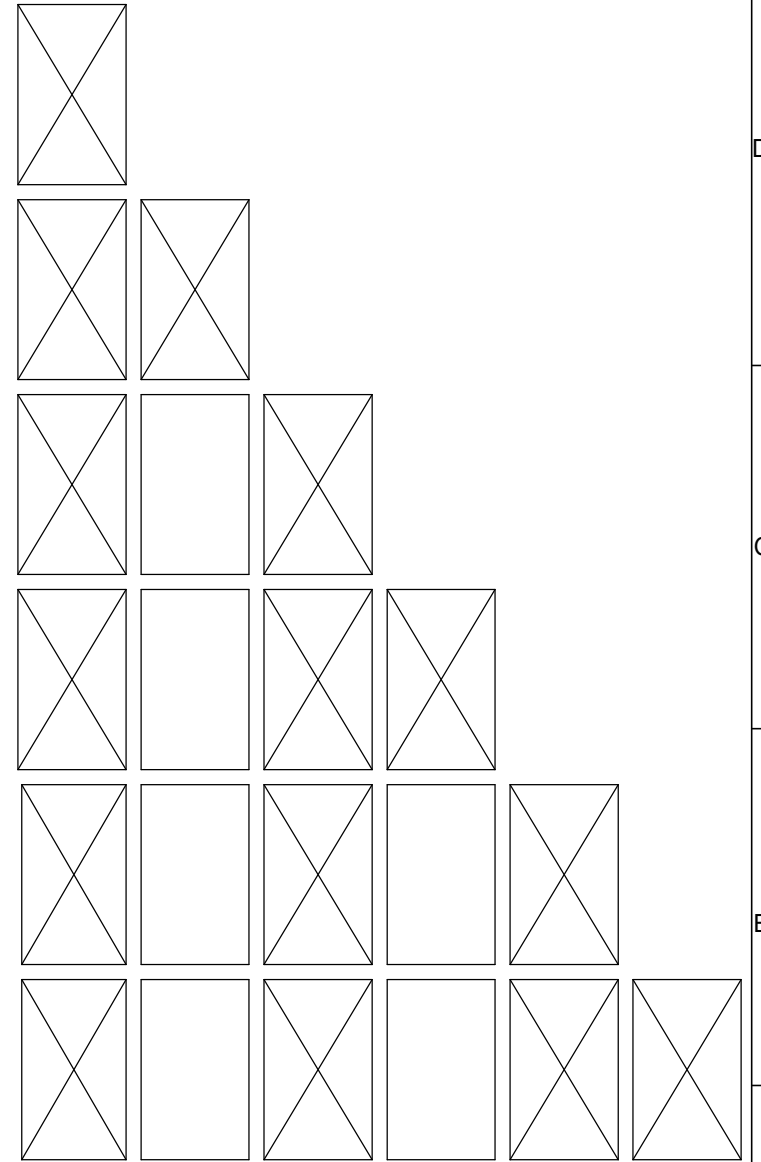

\* (2) GPASTBA'S NEEDED PER (1) UNIT.  
\* GPASTBA'S ARE NEEDED EVERY OTHER FIXTURE WHEN IN A RUN (SEE CHART).



**madix**  
**ASY-80034922**

P.O. BOX 729 TERRELL, TEXAS 75160  
214-515-5400 / 800-776-2349

PAGE 12 OF 13 REV. 00

SAM ECM # 500000013495

# LOAD CAPACITY INFORMATION

STATIC LOAD AND EVENLY DISTRIBUTED

MAXIMUM LOAD CAPACITY IN POUNDS FOR SHELVES & REBARS	
GPRB48	200 LBS /PAIR
GPRBC48	100 LBS /PAIR
GPRBL48	150 LBS /PAIR
GPLBSS	40 LBS /4 BKT
GPWGS4822	40 LBS
GPWBLS482404	40 LBS
GPWTS361204	40 LBS
GPHDWGS4818	200 LBS
GPHDWTS481804	200 LBS

MAXIMUM LOAD CAPACITY IN POUNDS FOR WIRE FIXTURE PANELS	
GPWFP	1000 LBS / WIRE FIXTURE PANEL



**madix**  
**ASY-80034922**  
P.O. BOX 729 TERRELL, TEXAS 75160  
214-515-5400 / 800-776-2349

PAGE 13 OF 13	REV. 00
SAM	ECM # 500000034922