

HEAVY-DUTY SYSTEMS

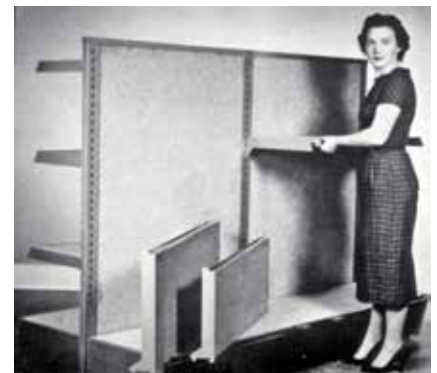

madix
INNOVATION ON DISPLAY

Table of Contents

Pallet Rack 3

- Pallet Rack Column Loading 3
- Pallet Rack Frames & Beams 4
- Pallet Rack Deck Supports 5
- Pallet Rack Decks 6
- Pallet Rack Accessories 8
- Vertical Divider–Beam Mount 10
- Horizontal Divider–Beam Mount 11
- Pallet Rack Signs 12
- Pallet Rack Displays 13
- Pallet Rack Security 16
- Suspended Maxi in Pallet Rack 21
- Pallet Rack Roll Goods Display 23
- @Front Roller-Shelf System for Heavy-Duty 24



Wide Span 27

- Wide Span Frame Loading 27
- Wide Span Frames & Beams 28
- Wide Span Deck Supports 29
- Wide Span Decks 30
- Wide Span Accessories 33
- Wide Span Vertical Divider Beams & Arms 36
- Wide Span Hooks 38
- Roll-Around Unit 39
- Wide Span Roll Goods Display 39
- Trailer Coupler & Jack Displays 40

- Suspended Maxi in Wide Span 41
- Wide Span Gravity Feed Battery Rack 43
- Wide Span Dog Food Display 44
- Wide Span Bulk Merchandise 45
- Wide Span Security Doors 47
- Wide Span Adjustable Tire Display 49
- Wide Span Gravity Feed System 50
- Wide Span Sign Holders 52
- Maxi Rack** 53

 - Maxi Rack Beam Loading 53
 - Maxi Rack Frame & Beams 54
 - Maxi Rack Deck Support & Decks 55
 - Maxi Rack Gravity Feed System 56
 - Maxi Rack Accessories 57

- Maxi Span** 58

 - Maxispan Frame Loading 58
 - Maxispan Upright & Beam 59
 - Maxispan Deck Support 60
 - Maxispan Decks 61

- Omega** 62

 - Omega Frame Loading 62
 - Omega Merchandising System 63
 - Omega Wood & Wire Decks 67
 - Omega Molding Rack 69
 - Omega Accessories 71

- Anchoring** 72



www.madixinc.com

Texas 500 Airport Road, Terrell, TX 75160 | 1010 S. Bolton, Jacksonville, TX 75766
Alabama 20984 Alabama Hwy. 9, Goodwater, AL 35072 | 500 Madix Drive, Eclectic, AL 36024

Pallet Rack Column Loading

- Column loading is the maximum vertical load that may be applied on any frame (measured in lbs)
- Each frame bears one-half of the load of each beam pair that it supports
- Regular-duty frames: 17,000 lb load capacity
- Heavy-duty frames: 26,000 lb load capacity

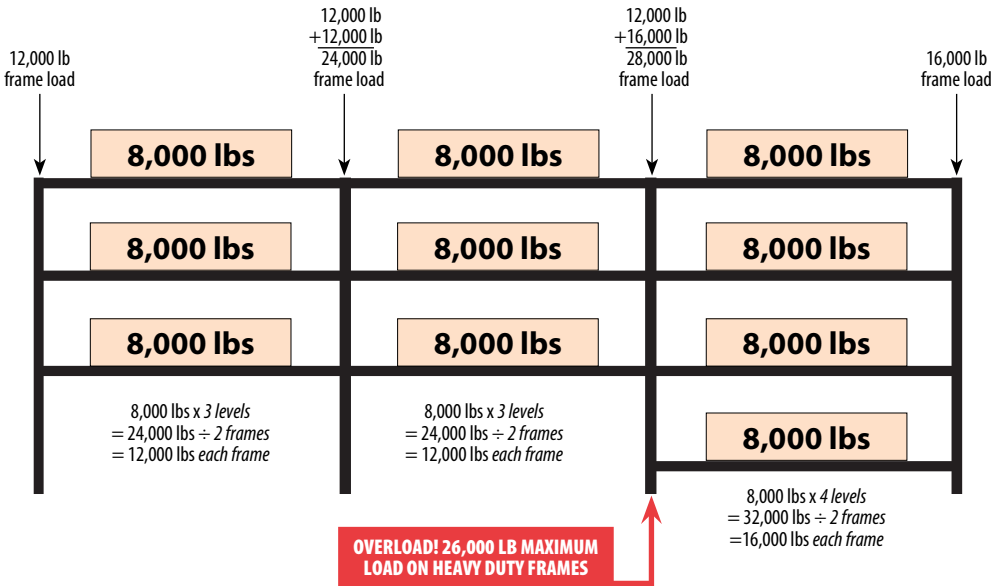

Vertical Impact Load

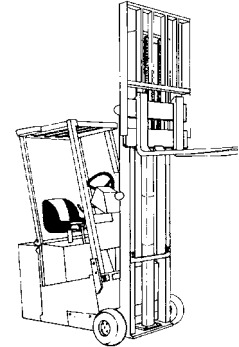

Considering the magnitude of forces that are involved, no beam can be designed and guaranteed against failure if a pallet is dropped onto Pallet Rack. Most beam failures occur due to improper placement and removal of pallets. It is the sole responsibility of the owner to make sure that trucks are operated only by authorized drivers who have been properly trained.

Pallet Rack Beam Spacing

- Spacing over 48" (1219 mm) vertically reduces column load capacity due to lack channel support
- When lowest beam is 48" (1219 mm) or higher from floor, always secure frame to floor
- All load capacities are based on even weight distribution

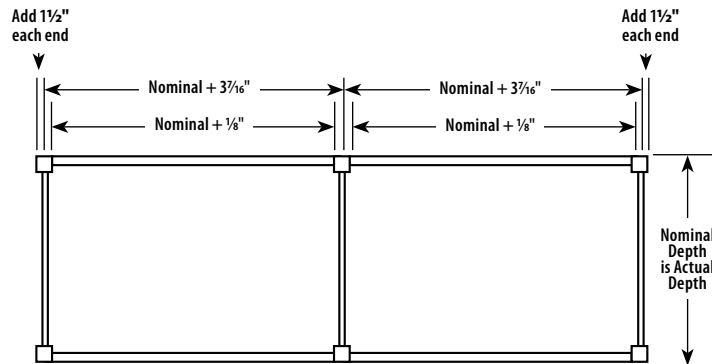

Pallet Rack Frame

- Frames feature welded footplates
- 2" (51 mm) OC beam adjustment
- Size availability to 48" (1219 mm) wide and 192" (4877 mm) high
- Allow minimum pallet overhang of 2" (51 mm) front and 2" (51 mm) rear when selecting frame size
- Standard finishes: Sahara or Blue Gray

PR2(TYPE)F(ND)(NH)

PR2 Pallet Rack 2" (51 mm) OC

TYPE HD=Heavy-Duty, RD=Regular-Duty

F Frame

ND Nominal Frame Depth 24" to 48" in 6" increments
(610 mm to 1219 mm in 152 mm increments)

NH Nominal Frame Height 72", 84", 96", 108", 120", 132", or 144"
(1829 mm, 2134 mm, 2438 mm, 2743 mm, 3048 mm, 3353 mm, or 3658 mm)

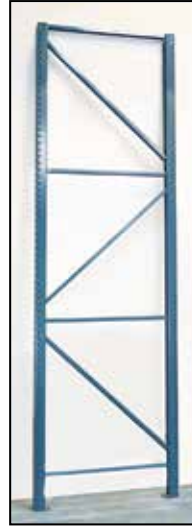
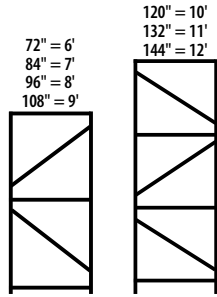
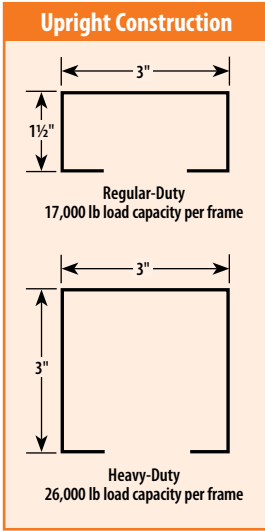
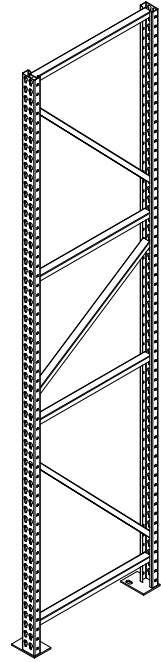

Heavy-Duty Pallet Rack Frame

NOTE!
To preclude overturning, the frame depth x 6 cannot exceed height of topmost loaded beam pair, unless all the frames are properly anchored or braced externally.

Pallet Rack Beam

- Available in three heights for differing load capacities
- Step depth accommodates 2" (51 mm) dimensional lumber decking, or wire decking
- Beams are slotted in step to accept deck supports under decking
- Standard finishes: Sahara or Blue Gray

PR2B(NH)(NL)-2

PR2 Pallet Rack 2" (51 mm) OC

B Beam

NH Nominal Beam Height

35=3 1/2" (89 mm)

50=5" (127 mm)

60=6" (152 mm)

NL Nominal Beam Length (See Chart)

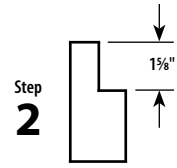

Beam Length x Beam Height	Maximum Capacity per Pair
36" x 3 1/2"	4,950 lbs
36" x 5"	7,600 lbs
36" x 6"	10,000 lbs
48" x 3 1/2"	4,950 lbs
48" x 5"	7,600 lbs
48" x 6"	10,000 lbs
60" x 3 1/2"	4,950 lbs
60" x 5"	7,600 lbs
60" x 6"	10,000 lbs
72" x 3 1/2"	4,950 lbs
72" x 5"	7,600 lbs

Beam Length x Beam Height	Maximum Capacity per Pair
72" x 6"	10,000 lbs
84" x 3 1/2"	4,950 lbs
84" x 5"	7,600 lbs
84" x 6"	10,000 lbs
96" x 3 1/2"	4,950 lbs
96" x 5"	7,600 lbs
96" x 6"	10,000 lbs
108" x 6"	9,110 lbs
120" x 6"	8,000 lbs
132" x 6"	7,270 lbs
144" x 6"	6,660 lbs

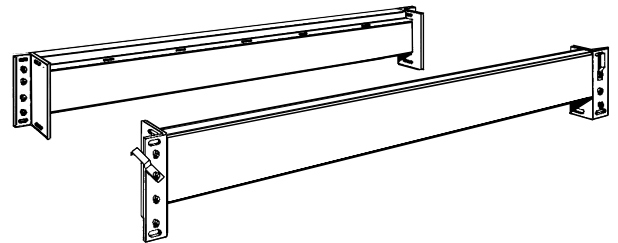

Pallet & Omega Rack Deck Support

- For 5/8" (16 mm) deck
- Formed, heavy-gauge steel with tabs fit into beam slots, providing support for regular-duty decking—or to tie beams together to prevent them from rotating when using heavy-duty decking
- Order by frame depth, in quantities shown in table on right
- Standard finishes: Sahara or Blue Gray

DSRPO-(ND)-1

DSRPO Pallet Rack Deck Supports
 ND Nominal Depth 24" to 48" in 6" increments
 (610 mm to 1219 mm in 152 mm increments)

Deck Supports per Beam Length		
Deck Type	Nominal Beam Length	Required Supports
Particle Board	36" to 72"	2
	84" to 108"	4
	120"	4
	132" to 144"	5
Wire Grid	36" to 48"	2
	60" to 96"	4
	108" to 144"	6
Flow Through	36" to 48"	2
	60" to 96"	4
	108" to 144"	6

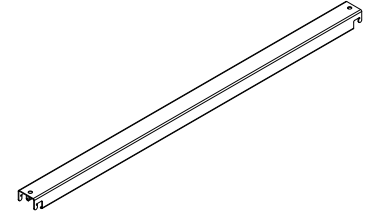

Pallet Rack Flush Deck Support

- Load-bearing pallet support
- Use one pair per pallet
- Fits flush with top of beam
- Load capacity 5,000 lbs/pair
- Standard finishes: Sahara or Blue Gray

MPRDSF(ND)-2

MPRDSF ... Pallet Rack Flush Deck Support
 ND Nominal Frame Depth 24" to 48" in 6" increments
 (610 mm to 1219 mm in 152 mm increments)
 2 2=1 5/8" (41 mm)

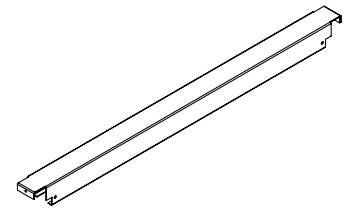

Pallet Rack Bottom Beam

- Mounts as close to the floor as possible
- Helps keep debris from under bottom deck
- Standard finishes: Sahara or Blue Gray

PR2B(NH)(NW)-2-B

PR2 Pallet Rack 2" (51 mm) OC
 B Beams
 NH Nominal Beam Height
 35=3 1/2" (89 mm)
 50=5" (127 mm)
 NW Nominal Width 36" to 144" in 12" increments
 (914 mm to 3658 mm in 305 mm increments)
 2 2=1 5/8" (41 mm)
 B Bottom

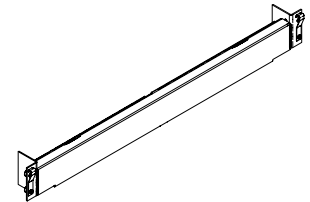

Pallet Rack Deck Support

- For 2" (51 mm) deck
- Formed, heavy-gauge steel with tabs fit into beam slots, providing support for regular-duty decking—or to tie beams together to prevent them from rotating when using heavy-duty decking
- Order by frame depth, in quantities shown in table on right
- Standard finishes: Sahara or Blue Gray

MPRDS-(ND)

MPRDS Pallet Rack Deck Supports
 ND Nominal Depth 24" to 48" in 6" increments
 (610 mm to 1219 mm in 152 mm increments)

Deck Supports per Beam Length		
Deck Type	Nominal Beam Length	Required Supports
Heavy-Duty	36" to 144"	2

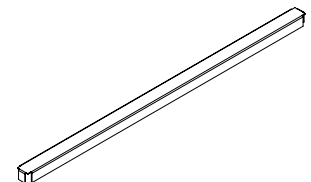

Pallet Rack Regular-Duty Deck

- Economical, 5/8" (16 mm), high-density particle board for lighter loads
- Not recommended where heavy pallets scrape the surface
- Use with Pallet Rack Deck Support [DSRPO-(ND)-1] only
- Not recommended for heavy, unevenly distributed loads

MPRRDD(ND)(NL)-U

MPR Pallet Rack
 RD Regular-Duty
 D Deck
 ND Nominal Frame Depth
 24" to 48" in 6" increments
 (610 mm to 1219 mm in 152 mm increments)
 NL Nominal Beam Length 36" to 96" in 12" increments
 (914 mm to 2438 mm in 305 mm increments)
 U Unsealed

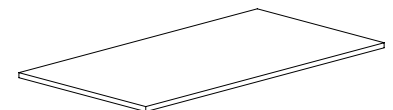

Deck Supports per Beam Length	
Nominal Beam Length	Required Supports
36" to 72"	2
84" to 108"	4
120"	4
132" to 144"	5

NOTE!
 Deck Supports are **NOT** included!

Pallet Rack Heavy-Duty Decking

- Unfinished, 2" (51 mm) dimensional lumber provides high loading capacity
- Use with Pallet Rack Deck Support [MPRDS-(ND)] only

MPRHDD-(ND)

- MPR Pallet Rack
- HD Heavy-Duty
- D Deck
- ND Nominal Frame Depth
24" to 48" in 6" increments
(610 mm to 1219 mm
in 152 mm increments)

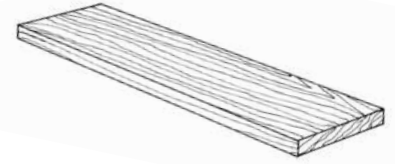

Nominal Frame Depth	Actual Length
24"	20 ⁷ / ₈ "
30"	26 ⁷ / ₈ "
36"	32 ⁷ / ₈ "
42"	38 ⁷ / ₈ "
48"	44 ⁷ / ₈ "

NOTE!
Deck Supports are **NOT** included!

Deck Supports per Beam Length	
Nominal Beam Length	Required Supports
36" to 144"	2

Order one piece per linear foot of beam

Pallet Rack Wire Grid Deck

- Sturdy wire, 5/16" (8 mm) gauge in diameter, is welded on 3" (76 mm) grid centers
- Use with Pallet Rack Deck Support [DSRPO-(ND)-1] only
- Standard finishes for Wire Grid Deck: Silver Vein, Sahara, and Blue Gray

PRWMS(ND)(NL)-3

- PR Pallet Rack
- WMS Wire Grid Deck
- ND Nominal Frame Depth 24" to 60" in 6" increments
(610 mm to 1524 mm in 152 mm increments)
- NL Nominal Piece Length 24" to 48" in 6" increments
(610 mm to 1219 mm in 152 mm increments)
- 3 Grid Size 3" OC (76 mm)



Wire grid piece length runs parallel to beam length

Deck Type	Nominal Beam Length	Combine these Piece Lengths to equal Beam Length	Required Quantity of Deck Supports
One-Piece Decks	36"	36"	2
	48"	48"	2
	60"	60"	2
Two-Piece Decks	72"	36" + 36"	4
	84"	42" + 42"	4
	96"	48" + 48"	4
Three-Piece Decks	108"	36" + 36" + 36"	6
	120"	36" + 48" + 36"	6
	132"	48" + 36" + 48"	6
	144"	48" + 48" + 48"	6

NOTE!
Deck Supports are **NOT** included!

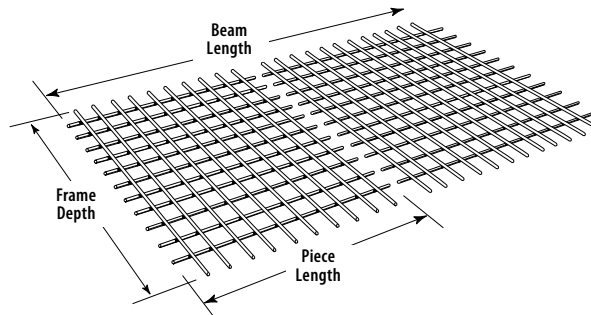

Frame Depth x Piece Length	Actual Frame Depth x Actual Piece Length
24" x 24"	20 ³ / ₄ " x 23 ³ / ₄ "
24" x 36"	20 ³ / ₄ " x 35 ³ / ₄ "
24" x 48"	20 ³ / ₄ " x 47 ³ / ₄ "
30" x 24"	26 ³ / ₄ " x 23 ³ / ₄ "
30" x 36"	26 ³ / ₄ " x 35 ³ / ₄ "
30" x 48"	26 ³ / ₄ " x 47 ³ / ₄ "
36" x 24"	32 ³ / ₄ " x 23 ³ / ₄ "
36" x 36"	32 ³ / ₄ " x 35 ³ / ₄ "
36" x 48"	32 ³ / ₄ " x 47 ³ / ₄ "
42" x 24"	38 ³ / ₄ " x 23 ³ / ₄ "
42" x 36"	38 ³ / ₄ " x 35 ³ / ₄ "
42" x 48"	38 ³ / ₄ " x 47 ³ / ₄ "
48" x 24"	44 ³ / ₄ " x 23 ³ / ₄ "
48" x 36"	44 ³ / ₄ " x 35 ³ / ₄ "
48" x 48"	44 ³ / ₄ " x 47 ³ / ₄ "

Flow Through Pallet Rack Deck

- Sturdy wire, 5/16" (8 mm) gauge in diameter welded on 3" (76 mm) grid centers with an expanded, metal mesh surface
- Use with Pallet Rack Deck Support [DSRPO-(ND)-1] only
- Provides 35% open space
- Standard finishes for Wire Grid Decks: Silver Vein, Sahara, and Blue Gray

FTPR2D-(ND)(NL)

- FT Flow Through
- PR2D Pallet Rack Deck
- ND Nominal Frame Depth 24" to 48" in 6" increments (610 mm to 1219 mm in 152 mm increments)
- NL Nominal Piece Length 24" to 48" in 6" increments (610 mm to 1219 mm in 152 mm increments)



NOTE!
Deck Supports are **NOT** included!

Deck Type	Nominal Beam Length	Combine these Piece Lengths to equal Beam Length	Required Quantity of Deck Supports
One-Piece Decks	36"	36"	2
	48"	48"	2
Two-Piece Decks	60"	30" + 30"	4
	72"	36" + 36"	4
	84"	42" + 42"	4
Three-Piece Decks	96"	48" + 48"	4
	108"	36" + 36" + 36"	6
	120"	36" + 48" + 36"	6
	132"	48" + 36" + 48"	6
	144"	48" + 48" + 48"	6

Wire grid piece length runs parallel to beam length

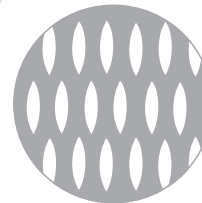
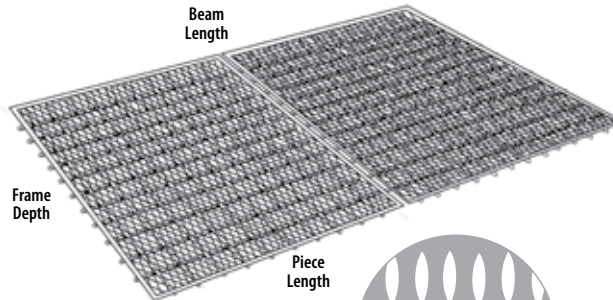

Sample Metal Grid Pattern

Frame Depth x Piece Length	Actual Frame Depth x Actual Piece Length
24" x 24"	20 3/4" x 23 3/4"
24" x 36"	20 3/4" x 35 3/4"
24" x 48"	20 3/4" x 47 3/4"
30" x 24"	26 3/4" x 23 3/4"
30" x 36"	26 3/4" x 35 3/4"
30" x 48"	26 3/4" x 47 3/4"
36" x 24"	32 3/4" x 23 3/4"
36" x 36"	32 3/4" x 35 3/4"
36" x 48"	32 3/4" x 47 3/4"
42" x 24"	38 3/4" x 23 3/4"
42" x 36"	38 3/4" x 35 3/4"
42" x 48"	38 3/4" x 47 3/4"
48" x 24"	44 3/4" x 23 3/4"
48" x 36"	44 3/4" x 35 3/4"
48" x 48"	44 3/4" x 47 3/4"

Pallet Rack Waterfall Wire Grid Deck

- Sturdy wire, 5/16" (8 mm) gauge in diameter, is welded on 3" (76 mm) grid centers to form decking
- Integrated supports eliminate standard deck supports
- Standard finishes for Waterfall Wire Grid Decks: Silver Vein, Sahara, and Blue Gray

PRFWGD(ND)(NL)-3

- PR Pallet Rack
- WF Waterfall
- WGD Wire Grid Deck
- ND Nominal Frame Depth 24" to 48" in 6" increments (610 mm to 1219 mm in 152 mm increments)
- NL Nominal Piece Length 24" to 48" in 6" increments (610 mm to 1219 mm in 152 mm increments)
- 3 Grid Size 3" (76 mm) OC

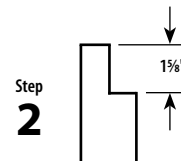
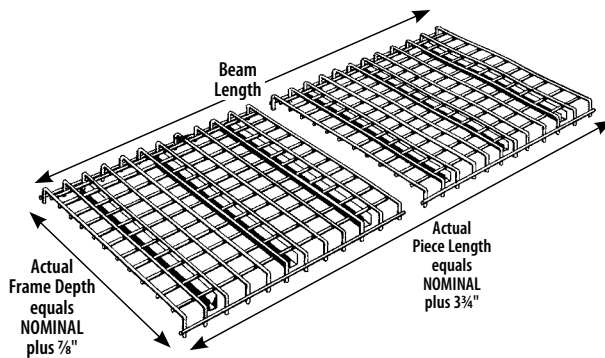

Nominal Beam Length	Combine these Piece Lengths to equal Beam Length
36"	36"
48"	48"
60"	30" + 30"
72"	36" + 36"
84"	42" + 42"
96"	48" + 48"
108"	36" + 36" + 36"
120"	36" + 48" + 36"
132"	48" + 36" + 48"
144"	48" + 48" + 48"

Pallet Rack Back-to-Back Connector

- Heavy-gauge connector keeps back-to-back runs properly spaced
- Use two connectors on frames up to 96" (2438 mm) high; three on taller units
- Hardware included
- Standard finishes: Sahara or Blue Gray

PRBBC(ND)

- PR Pallet Rack
- BBC Back-to-Back Connector
- ND Nominal Back Spacing 2" to 12" in 1" increments (51 mm to 305 mm in 25 mm increments)

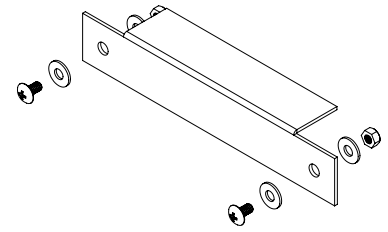

Pallet Rack Pallet Stop

- Heavy-gauge angle aids in pallet positioning
- Easily attaches to decking or beam with supplied hardware
- Standard finishes: Sahara or Blue Gray

PRPS-(NL)

- PRPS Pallet Rack Pallet Stop
- NL Nominal Length 36" to 96" in 12" increments (914 mm to 2438 mm in 305 mm increments)

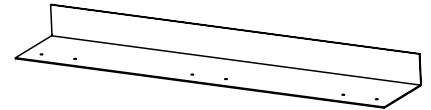

Pallet Rack 2" Stop Beam

- Stops pallets from overhanging the rear beam
- Positions pallet to sit in proper location
- Standard finishes: Sahara or Blue Gray

PR2PSB(NW)

- PR2PSB Pallet Rack 2" Pallet Stop Beam
- NW Nominal Width 36" to 96" in 12" increments (914 mm to 2438 mm in 305 mm increments)

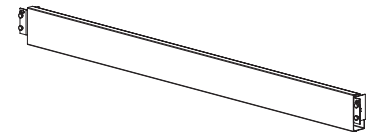

Pallet Rack Stop 2" OC with 3" Offset

- Allows oversized pallets to overhang beams by 3" (76 mm)
- Standard finishes: Sahara or Blue Gray

PR2PS3-(NW)

- PR2PS Pallet Rack 2" Pallet Stop Beam
- 3 3" Offset
- NW Nominal Length 36" to 96" in 12" increments (914 mm to 2438 mm in 305 mm increments)

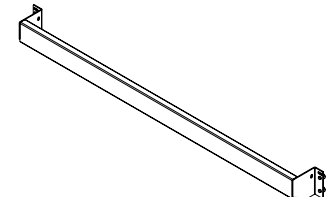

Pallet Rack Frame Guard

- For Pallet Rack Frames only
- Vertical member is heavy-gauge tubing
- 24"H x 5"W x 2"D (610 mm x 127 mm x 51 mm), welded to 16" (406 mm) foot plates
- Hardware pack includes ICBO-approved expansion bolts to secure guard to floor
- Two guards are required at each end of single or back-to-back runs
- Standard finishes: Sahara or Blue Gray

PRUG

- PRUG Pallet Rack Frame Guard

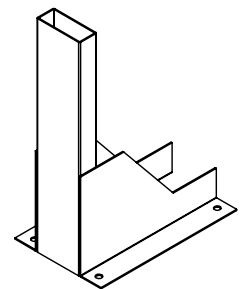

Pallet Rack Frame Protector

- 18" (457 mm) high, heavy-gauge channel accommodates standard foot plate, to protect the frame posts
- Hardware pack includes bolts to secure protector to frame and two ICBO-approved expansion bolts for anchoring
- Standard finishes: Sahara or Blue Gray

FP18

FP18 Pallet Rack Frame Protector

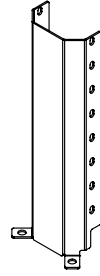

Pallet Rack Leveling Shim

- Available in 10-packs, consisting of five 12-gauge and five 16-gauge shims for leveling Pallet Rack systems
- Galvanized finish

PRSHM

PRSHM Pallet Rack Leveling Shim

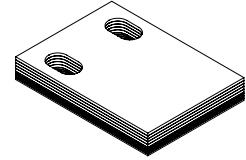

Pallet Rack Floor Anchor Kit

- ICBO approved expansion bolts for use as floor anchors for Pallet Rack systems
- Dimensions: 1/2" – 13 x 4 1/2"
- Always check local requirements and site conditions to determine correct fastener for application

PRFAK-(OPT)

PRFAK Pallet Rack Floor Anchor Kit

OPT Blank=4 pack of anchor
1=1 anchor

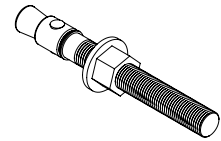

Pallet Rack Wall Mount Bracket

- Heavy gauge bracket assures consistent spacing from frame to wall
- Hardware pack includes bolts to secure bracket to frame
- Not recommended for use when seismic certification-required
- Standard finishes: Sahara or Blue Gray

PRWMB-(ND)

PR Pallet Rack

WMB Wall Mount Bracket

ND Nominal Frame Depth 6" to 12" in 2" increments
(152 mm to 305 mm in 51 mm increments)

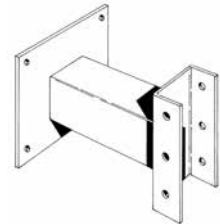

Vertical Dividers—Beam Mount

M Vertical Divider for Pallet Rack Box Beam

- Mounts to Pallet Rack Beams with supplied hardware
- Available in regular or heavy-duty:
 - Regular-duty: heavy-gauge wire construction
 - Heavy-duty: 1" (25 mm) tubing construction
- Both 18" (457 mm) and 20" (508 mm) heights are U-shaped; all others M-shaped
- Standard finishes: Sahara or Blue Gray

MVDA-(ND)(NH)(TYPE)-PR

MVDA M-Vertical Divider Arm for Pallet Rack
 ND Nominal Depth 20", 22", 24", 26", 30", 32", 36", 38", 40", 42", 44", 50" or 56"
 (508 mm, 559 mm, 610 mm, 660 mm, 762 mm, 813 mm, 914 mm, 1016 mm, 1067 mm, 1118 mm, 1270 mm or 1422 mm)
 NH 24", 30", 36", 42", 48", 54" or 60"
 (610 mm, 762 mm, 914 mm, 1067 mm, 1372 mm or 1524 mm)
 TYPE H=Heavy-Duty, R=Regular-Duty
 PR Pallet Rack

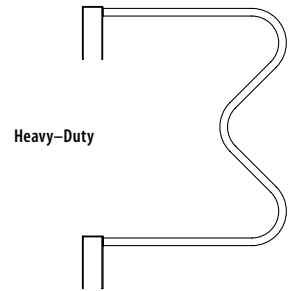
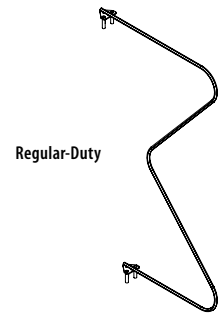

M Vertical Divider for Pallet Rack Molding Rack Beam

- Mounts to Pallet Rack Molding Rack Beams [WSMRB-(NL)(STANDOFF)]
- Heavy-gauge wire construction
- Upper depth is same as lower depth

MVDA-(ND)(NH)R-M

MVDA M-Vertical Divider Arm for Pallet Rack
 ND Nominal Depth 20" or 22"
 (508 mm, 559 mm)
 NH 24", 30" or 36"
 (610 mm, 762 mm or 914 mm)
 R Regular-Duty
 M Modified

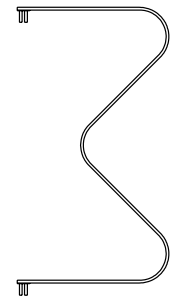

M Vertical Divider with Three Supports for Pallet Rack

- Mounts to three Pallet Rack Beams with supplied hardware
- 72" (1829 mm) nominal height and 30" (762 mm) nominal depth
- Heavy-gauge wire construction
- Standard finishes: Sahara or Blue Gray

MVDA3-3072-PR

MVDA M-Vertical Divider Arm for Pallet Rack
 3 3 Supports
 30 Nominal Depth 30" (762 mm)
 72 Nominal Height 72" (1829 mm)
 PR Pallet Rack

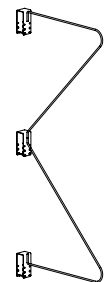

Wire Grid Divider

- Wire grid panel mounts to two Pallet Rack Beams with supplied hardware
- Heavy-gauge wire construction
- Standard finishes: Sahara or Blue Gray

WGVDA-(ND)(NH)-CPR

WGVDA Wire Grid Vertical Divider Arm
 ND Nominal Depth 36" (914 mm)
 NH Nominal Height 32" (813 mm)
 CPR Clip for Pallet Rack

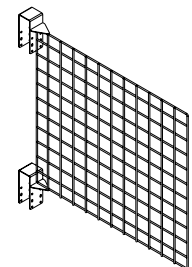

Vertical Divider Bar

- 1" (25 mm) OC punched cross tube with brackets to fit Pallet Rack Beam
- Mounting hardware included
- Use with regular or heavy-duty Vertical Divider Arms [VDA-(NL)(TYPE)] to create vertical divisions
- Standard finishes: Sahara or Blue Gray

VDBPRB-(NW)(ND)

VDBPRB.... Vertical Divider Bar Pallet Rack
 NW Nominal Width
 3' (914 mm) and 4' (1219 mm)
 ND Nominal Depth 02" (51 mm)

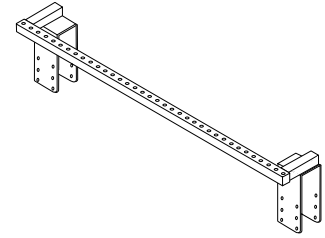
**Horizontal Dividers-Beam Mount****Vertical Divider Arm**

- Mounts to Vertical Divider Bar, either straight-in or at 45°
- Arms may be mounted to front and rear of standoff bars
- Regular-duty divider arms are 3/8" (10 mm) diameter with red neoprene safety tip
- Heavy-duty arms are 1" (25 mm) square tubing with vinyl safety cap
- Standard finishes: Sahara or Blue Gray

VDA-(NL)(TYPE)

VDA Vertical Divider Arms
 NL Nominal Frame Length
 R=4"-24" in 2" increments
 (102 mm-610 mm in 51 mm increments)
 H=10"-30" in 2" increments
 (254 mm-762 mm in 51 mm increments)
 TYPE R=Regular-Duty, H=Heavy-Duty

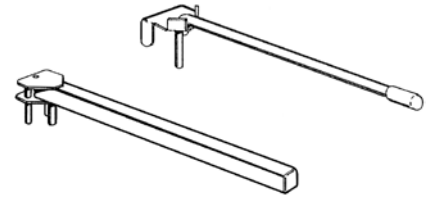
**Horizontal Divider Arm, Step Beam**

- Mounts to Pallet Rack Beam pairs with supplied hardware
- Tubing construction
- Height for all sizes is 48" (1219 mm)
- Standard finishes: Sahara or Blue Gray

HDA-SB-(ND)

HDA Horizontal Divider Arm
 SB Step Beam
 ND Nominal Depth 30", 36", 48" or 60"
 (762 mm, 914 mm, 1219 mm or 1524 mm)

**M Vertical Divider Single Arm**

- Mounts to Pallet Rack Beam with supplied hardware
- Tubing construction with plastic cap
- Standard finishes: Sahara or Blue Gray

MVDSA-(ND)

MVD M-Vertical Divider
 SA Single Arm
 ND Nominal Depth 18", 24", 26", 32", 36" or 44"
 (457 mm, 610 mm, 660 mm, 813 mm,
 914 mm or 1118 mm)

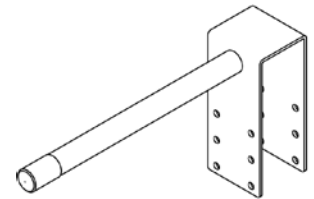
**Cut Plywood Divider**

- Two-piece rack has 30 1/2" (775 mm) interlocking vertical tubes for height adjustment
- Minimum height is 31" (787 mm); maximum height is 58" (1473 mm)
- Attaches to wood decking with screws
- Standard finishes: Sahara or Blue Gray

OCPD-(ND)

OCPD Omega Cut Plywood Divider
 ND 36", 42", 48" or 60"
 (914 mm, 1067 mm, 1219 mm or 1524 mm)

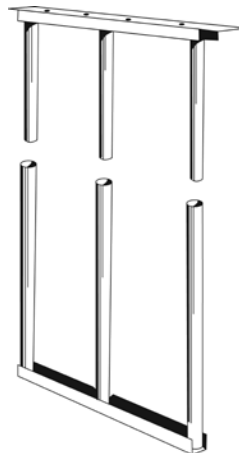

Pallet Rack Beam Cover with Sign Holder

- Hooks over top of Pallet Rack Beam
- Signage dimension 5¼" (133 mm) H, maximum thickness of 3/8" (10 mm)
- Visible height of signage 4⅝" (118 mm)
- Recommended signage length: 1/32" (0.3 mm) less than width of beam cover
- Standard finishes: Sahara or Blue Gray

PR2BCS-(NH)(NW)

PR2BCS Pallet Rack Beam Cover with Sign Holder
 NH Nominal Height 35=3½", 50=5" or 60=6"
 (89 mm, 127 mm or 152 mm)
 NW Nominal Width 36", 48", 60", 72", 84" or 96"
 (914 mm, 1219 mm, 1524 mm, 1829 mm, 2134 mm or 2438 mm)

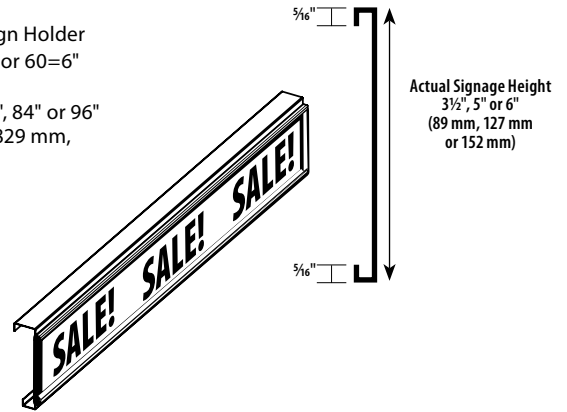

Rug Display for Box Beam

- Brackets supported by box beams
- Rear bracket has welded tube, front has cutout for supplied tubing
- Tubing is 60" (1524 mm) long and may be field cut for smaller depth applications
- Mounting screws included
- Rug Display Clips sold separately
- Standard finishes: Sahara or Blue Gray

RDBB

RDBB Rug Displayer for Box Beam

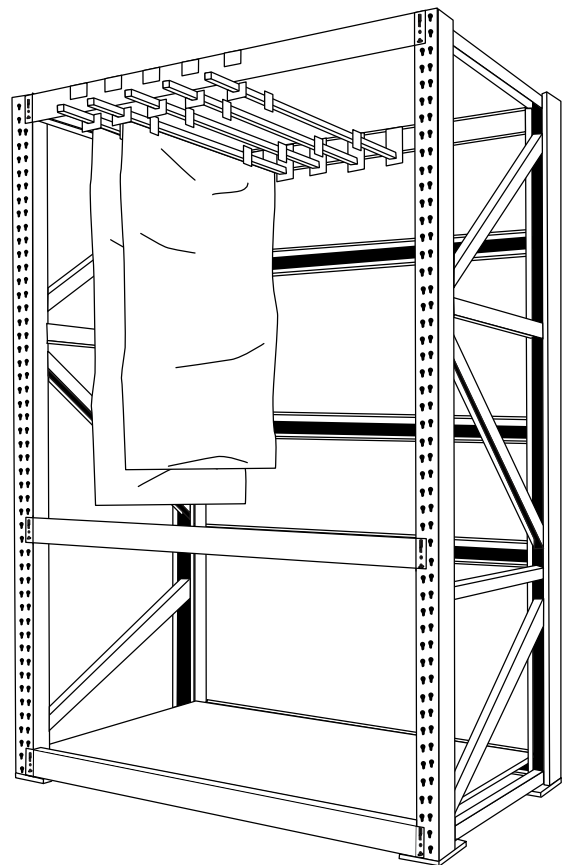
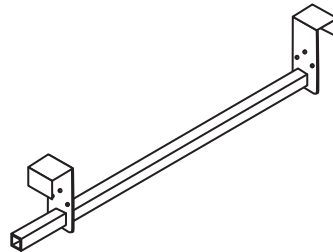

Rug Display Clip

- Clip hangs on RDBB tube
- 40 clips in each pack
- Standard finishes: Sahara or Blue Gray

RDC-40

RDC Rug Display Clip
 40 40 Pack

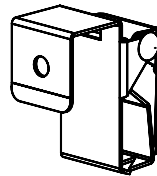

Pallet Rack Loop Merchandiser

- Cross merchandise products on Pallet Rack Uprights
- Choice of open loop for vertically displayed items or closed loop with expanded metal bottom
- Hardware pack included for easy installation
- Standard finishes: Sahara or Blue Gray

PR2LM-(D)-(TYPE)

PR2LM Pallet Rack Loop Merchandiser
 D Diameter 06", 10" or 12"
 (152 mm, 254 mm or 305 mm)
 TYPE O=Open, C=Closed

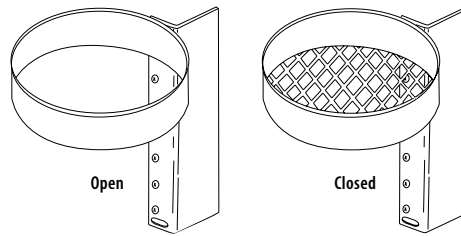

Cross Merchandise Basket

- Wire mesh basket
- 15"W x 10"D x 12"H
(381 mm x 254 mm x 305 mm)
- Bolts to Pallet Rack Upright
- Standard finishes: Sahara or Blue Gray

CMB

CMB Cross Merchandise Basket



Wide Span Garden Tool Display Bar

- Heavy-duty upright channel welded to Pallet Rack brackets
- May be used on both Wide Span and Pallet Rack uprights
- Allows use of beam-mounted accessories with locking clips– no hardware required
- 2" (51 mm) OC slotting
- Standard finishes: Sahara or Blue Gray

WSGTDB-(NL)

WSGTDB Wide Span Garden Tool Display Bar
 NL Nominal Length 48" or 96"
 (1219 mm or 2438 mm)

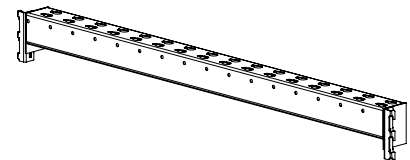

Wide Span Single Hook Display

- Single arm for crossbar
- Works on Garden Tool Display Bar
- Fits 2" (51 mm) OC slotting
- Standard finishes: Sahara or Blue Gray

WSSHD-(ND)

WS Wide Span
 SHD Single Hook Display
 ND Nominal Depth 18", 24", 30" or 36"
 (457 mm, 610 mm, 762 mm or 914 mm)

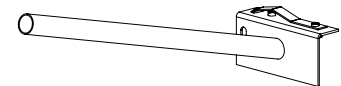

Wide Span Garden Tool Display Double Hook

- Double, square, tube arm
- Works on Garden Tool Display Bar
- Fits 2" (51 mm) OC slotting
- Standard finishes: Sahara or Blue Gray

WSGTDH-(ND)

WS Wide Span
 GTDH Garden Tool Double Hook
 ND Nominal Depth 18", 24", 30" or 36"
 (457 mm, 610 mm, 762 mm or 914 mm)

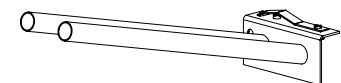

Wide Span Molding Rack Beam

- Box beam with welded 1" (25 mm) OC punched cross tube
- Use with regular or heavy-duty Vertical Divider Arms to create compartments
- Arms may be oriented face in or face out
- Standard finishes: Sahara or Blue Gray

WSMRB-(NL)(STANDOFF)

WSMRB Wide Span Molding Rack Beam
 NL Nominal Length 48", 60", 72", 84" or 96"
 (1219 mm, 1524 mm, 1829 mm, 2134 mm or 2438 mm)
 STANDOFF 02", 08", or 14" (51 mm, 203 mm or 356 mm)

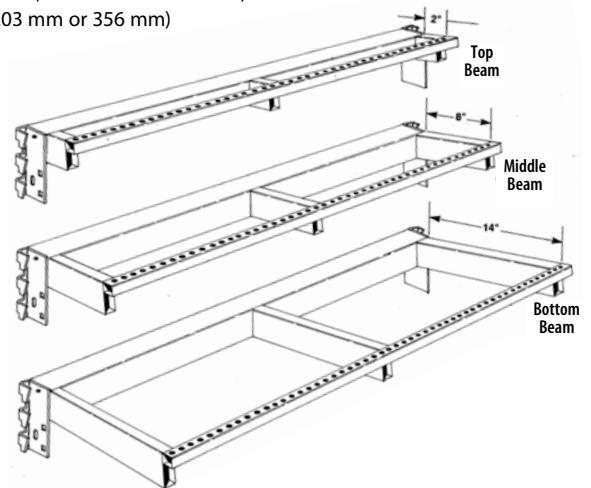

Wide Span Retainer Pin

- Required to lock Molding Rack Beams in place
- Standard finishes: Sahara or Blue Gray

WSREP-20

WSREP Wide Span Retainer Pin
 20 20 Pack



Pallet Rack Gravity Feed Channel

- Formed metal channel with variable width for products
- 2" (51 mm) high
- Order depth to match frame depth
- Order DROP based on positioning of beams—4", 6", 8" or 10" (102 mm, 152 mm, 203 mm or 254 mm) difference from rear to front beam placement height
- Standard finishes: Sahara or Blue Gray

PR(ND)GFC(DROP)-(NW)02

PR Pallet Rack
 ND Nominal Depth 18", 24", 30", 36", 42", 48" or 60"
 (457 mm, 610 mm, 762 mm, 944 mm, 1067 mm or 1219 mm)
 GFC Gravity Feed Channel
 DROP Drop 04=4", 06=6", 08=8 or 10"
 (102 mm, 152 mm, 203 mm or 254 mm)
 NW Nominal Width 46=4.562", 55=5.5",
 65=6.5" or 76=7.625" (116 mm,
 140 mm, 165 mm or 194 mm)
 02 Channel Height

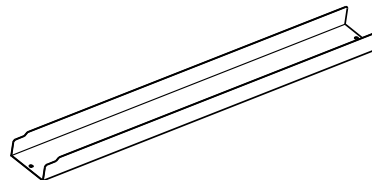

Pallet Rack Ladder Display Assembly

- Mounts to Pallet Rack Beam with supplied hardware
- 33" D (838 mm) heavy-duty arm with gusset
- 2½" x 2½" (64 mm x 64 mm) tag plate
- Standard finishes: Sahara or Blue Gray

PRLDA33

PRLDA Pallet Rack Ladder Display Assembly
 33 Nominal Length 33" (838 mm)



Pallet Rack Pipe Bracket, Side Mount

- H-side mount bracket mounts to Pallet Rack Frame [PR2(TYPE)F(ND)(NH)]
- Sold in pairs
- Standard finishes: Sahara or Blue Gray

PRPB-(ND)

PRPB Pallet Rack Pipe Bracket
 ND Nominal Depth 8", 12", 16", 20" or 24"
 (203 mm, 305 mm, 406 mm, 508 mm or 607 mm)

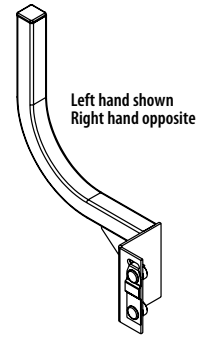

Pallet Rack Pipe Bracket, Front Mount

- H-front-mount bracket mounts to Pallet Rack Frame [PR2(TYPE)F(ND)(NH)]
- Sold in pairs
- Standard finishes: Sahara or Blue Gray

PRPB-(ND)FM

PRPB Pallet Rack Pipe Bracket
 ND Nominal Depth 8", 12", 16", 20" or 24"
 (203 mm, 305 mm, 406 mm, 508 mm or 607 mm)
 FM ... Front Mount

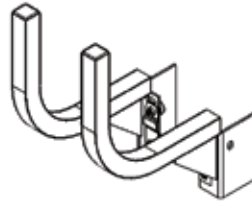

Weed Eater Holder

- Height-adjustable bracket mounts to Rack Frame [PR2(TYPE)F(ND)(NH)]
- Wire holder with black vinyl caps
- Standard finishes: Sahara or Blue Gray

WEHPR

WEHPR Weed Eater Holder for Pallet Rack

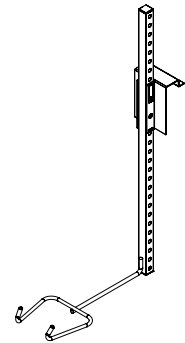

Pallet Rack TV Bracket

- Mounts to end of Pallet Rack using four 3/8-3/16 x 1" bolts
- Nominal widths 36", 42" or 48" (914 mm, 1067 mm or 1219 mm)
- Mounting slots are located toward top to allow gusset-style mounting and securing of aftermarket TV-mounting brackets

LCDTVCBPREM(NW)

LCDTVCB.....LCD TV Crossbar
 PR.....Pallet Rack
 EM.....End Mount
 NW.....Nominal Width 36", 42" or 48"
 (944 mm, 1067 mm or 1219 mm)

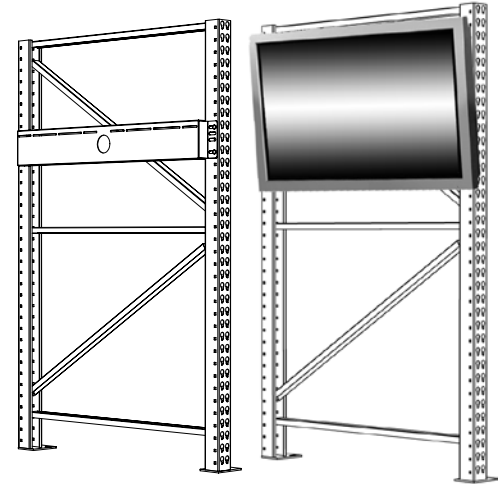
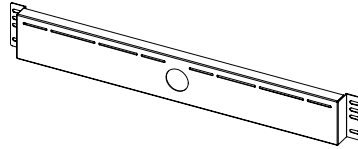

Pallet Rack Security Doors

- Optional panel type:
 - 2" x 2" wire grid (76 mm x 76 mm)
 - 1" x 6" wire grid (25 mm x 152 mm)
 - Hardboard
- Locking device is customer supplied
- Standard finishes: Sahara or Blue Gray

Pallet Rack Security Doors		
Description	Part Number	Qty.
A Pallet Rack Side Security Panels	PRSSP-(NW)(ND)	2
B Pallet Rack Security Doors	PRSD2X2-(NW)(NH)(OPTION)	2
C Pallet Rack Frame	PR2(TYPE)F(ND)(NH)	3
D Pallet Rack Upper Security Deck	PRUSD-(NW)(ND)	2
* Pallet Rack Security Door Hinged Hardware Kit	PRSDHHK	2
* Pallet Rack Security Deck Hardware Kit	PRSDHK-1	2

*Not visible

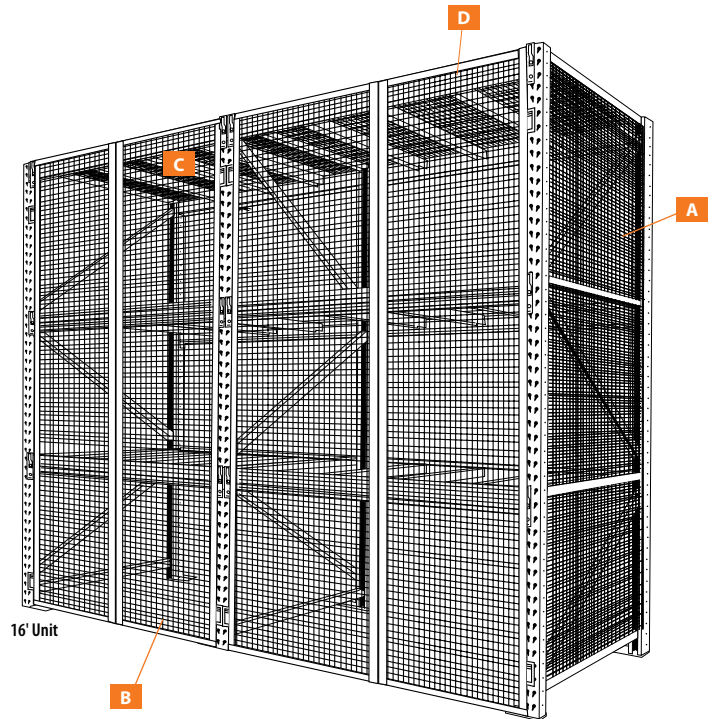

A Pallet Rack Side Security Panel

- Side Security Panels prohibit side access to merchandise
- 2" x 2" (51 mm x 51 mm) panels with welded brackets fasten to the cross bracing on Pallet Rack Frame with self threading screws
- Order PRSDHK-1 kit for all necessary hardware
- Standard finishes: Sahara or Blue Gray

PRSSP-(NH)(ND)

PRSSP Pallet Rack Side Security Panel
 NH Nominal Height 48", 84", 96" or 120"
 (1219 mm, 2134 mm, 2438 mm or 3048 mm)
 ND Nominal Depth 30", 36" or 48"
 (762 mm, 914 mm or 1219 mm)

Nominal Height	Number of Panels
48"	1
84"	2
96"	2
120"	3

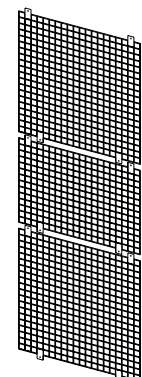

B Pallet Rack Security Doors

- Secure merchandise by adding Pallet Rack Security Doors to either new or existing Pallet Rack systems
- Built of 2" x 2" (51 mm x 51 mm) wire grid
- Locking device supplied by customer
- Order the Pallet Rack Security Door Hardware Kit, PRSDHHK, and Pallet Rack Security Deck Hardware Kit, PRSDHK-1, to attach doors to Pallet Rack Frames (ordered separately)
- Standard finishes: Sahara or Blue Gray

PRSD2X2-(NW)(NH)(OPT)

PRSD Pallet Rack Security Doors–
 2X2 2"x 2" (51 mm x 51 mm) Grid
 NW Nominal Width 48" or 96"
 (1219 mm or 2438 mm)
 NH Nominal Height 48", 72", 84", 96", 108" or 120"
 (1219 mm, 1829 mm, 2134 mm, 2438 mm,
 2743 mm or 3048 mm)
 OPT Security Panel Option:
 Blank=With Security Panels
 NSP=No Security Panels

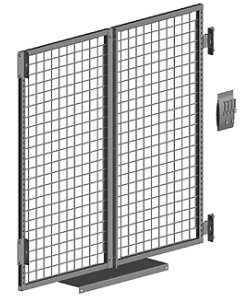

Shown with Hinge Kit (PRSDHHK) and Security Panels

C Pallet Rack Frames

- Frames feature welded footplates
- 2" (51 mm) OC beam adjustment
- Size availability to 48" (1219 mm) wide and 144" (3658 mm) high
- Allow minimum pallet overhang of 2" (51 mm) front and 2" (51 mm) rear when selecting frame size
- Standard finishes: Sahara or Blue Gray

PR2(TYPE)F(ND)(NH)

PR2 Pallet Rack 2" (51 mm) OC
 TYPE HD=Heavy-Duty, RD=Regular-Duty
 F Frame
 ND Nominal Frame Depth 24" to 48" in 6" increments
 (610 mm to 1219 mm in 152 mm increments)
 NH Nominal Frame Height 72", 84", 96", 108", 120",
 132" or 144" (1829 mm, 2134 mm, 2438 mm, 2743 mm,
 3048 mm, 353 mm or 3658 mm)

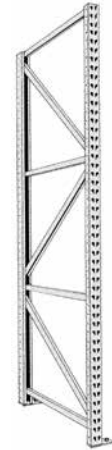

NOTE!

To preclude overturning, the frame depth x 6 cannot exceed height of topmost loaded beam pair, unless all the frames are properly anchored or braced externally.

D Pallet Rack Security Deck

- Eliminate access to merchandise stored on Pallet Rack systems
- Security Deck is fastened to beams using hardware in the Pallet Rack Security Door Hinged Hardware Kit (PRSDHHK) and Pallet Rack Security Deck Hardware Kit (PRSDHK-1, ordered separately)
- Standard finishes: Sahara or Blue Gray

PRUSD-(NW)(ND)

PRUSD Pallet Rack Upper Security Deck
 NW Nominal Width 72" or 96"
 (1829 mm or 2438 mm)
 ND Nominal Depth 24" to 48" in 6" increments
 (610 mm to 1219 mm in 152 mm increments)

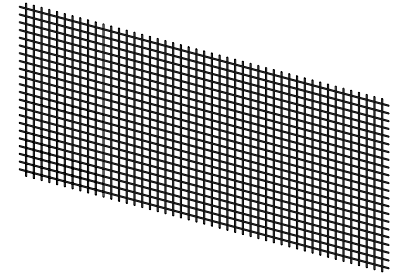

Pallet Rack Security Door Hinge Hardware Kit

- Includes all necessary screws and hardware components required to fasten set of Pallet Rack Security Doors, Upper Deck, and Side Security Panels to Pallet Rack system
- Standard finishes: Sahara or Blue Gray

PRSDHHK

PRSD Pallet Rack Security Door
 HHK Hinge Hardware Kit

Contents	Quantity
Right-Hand Hinges	2
Left-Hand Hinges	2
Deck Securing Brackets	6
Connecting Plates	6

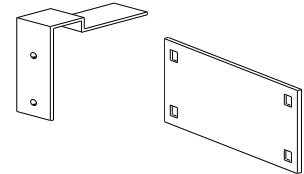

Pallet Rack Security Door Hardware Kit

- Includes assortment of nuts, bolts and washers

PRSDHK-1

PRSD Pallet Rack Security Door
 HK-1 Hardware Kit



Pallet Rack Wire Grid Product Retainer

- Tube-framed wire grid panels with attached pallet rack brackets provide protection from falling merchandise
- May be used as a rear security panel
- Standard finishes: Sahara or Blue Gray

PRWGPR-(NW)(NH)

PRWGPR... Pallet Rack Wire Grid Product Retainer
 NW Nominal Width 48", 96", 108" or 120"
 (1219 mm, 2438 mm, 2743 mm or 3048 mm)
 NH Nominal Height 42", 48", 54", 58", 60" or 66"
 (1067 mm, 1219 mm, 1372 mm, 1473 mm, 1524 mm or 1676 mm)

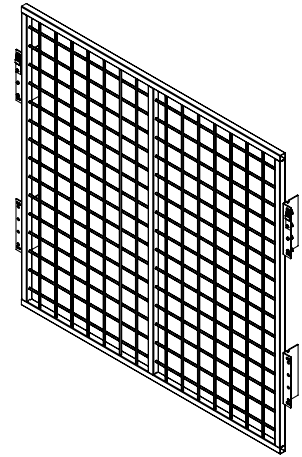

Pallet Rack Wire Grid Product Retainer 2" x 2"

- Tube-framed wire grid panels with attached pallet rack brackets provide protection from falling merchandise
- May be used as a rear security panel
- Standard finishes: Sahara or Blue Gray

PRWGPR2X2-(NW)(NH)

PRWGPR... Pallet Rack Wire Grid Product Retainer
 2X2 2" x 2" (51 mm X 51 mm)
 NW Nominal Width 48", 96" or 108"
 (1219 mm, 2438 mm or 2743 mm)
 NH Nominal Height 18", 36", 48", 54", 58",
 60", 66", 72" or 78" (457 mm, 914 mm,
 1219 mm, 1372 mm, 1473 mm, 1524 mm,
 1676 mm, 1829 mm or 1981 mm)

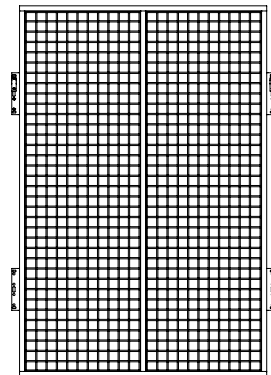

Pallet Rack Wire Grid Product Retainer 2" OC with Extended Bracket

- Tube-framed wire grid panels with attached pallet rack brackets provide protection from falling merchandise
- May be used as a rear security panel
- Standard finishes: Sahara or Blue Gray

PRWGPR2EB-(NW)(NH)

PRWGPR2Pallet Rack Wire Grid Product Retainer 2" OC
 EB.....Extended Bracket
 NW.....Nominal Width 108" (743 mm)
 NH.....Nominal Height 54" or 60"
 (1372 mm or 1524 mm)

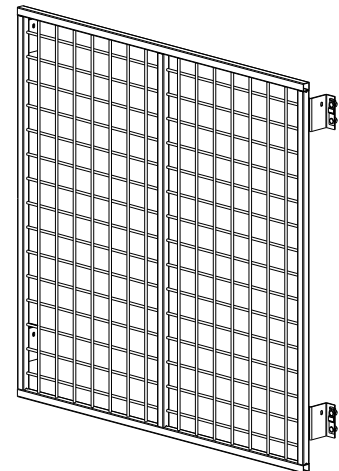

Pallet Rack Offset Security Doors

- 2" x 2" wire grid (76 mm x 76 mm)
- Locking device is customer supplied
- Standard finishes: Sahara or Blue Gray

Pallet Rack Offset Security Doors (as shown)		
Description	Part Number	Qty.
A Pallet Rack Side Security Panels	PRSSP-(NH)(ND)	2
B Pallet Rack Upright Security Panels	PRUSP-(NH)	2
C Pallet Rack Security Doors	PRSD2X2-(NW)(NH)(OPTION)	2
D Pallet Rack Security Door Hinged Hardware Kit	PRSDHHK	1
E Pallet Rack Security Door Hardware Kit	PRSDHK-1	1
F Pallet Rack Frame	PR2(TYPE)F(ND)(NH)	2
G Pallet Rack Upper Security Deck	PRUSD-(NW)(ND)	2

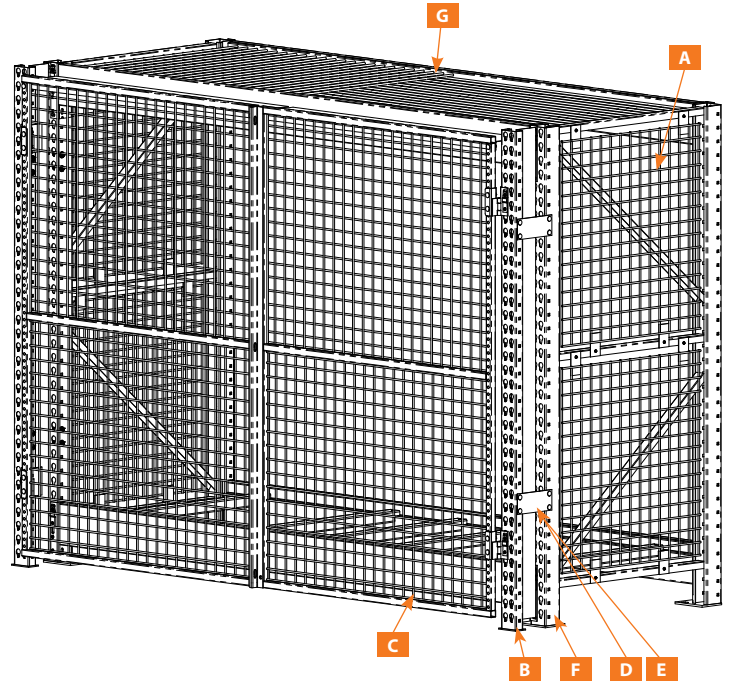

A Pallet Rack Side Security Panel

- Side Security Panels prohibit side access to merchandise
- 2" x 2" (51 mm x 51 mm) panels with welded brackets fasten to the cross bracing on Pallet Rack Frame with self-threading screws
- Order PRSDHK-1 kit for all necessary hardware
- Standard finishes: Sahara or Blue Gray

PRSSP-(NH)(ND)

PRSSP Pallet Rack Side Security Panel
 NH Nominal Height 48", 84", 96" or 120"
 (1219 mm, 2134 mm, 2438 mm or 3048 mm)
 ND Nominal Depth 30", 36" or 48"
 (762 mm, 914 mm or 1219 mm)

Nominal Height	Number of Panels
48"	1
84"	2
96"	2
120"	3

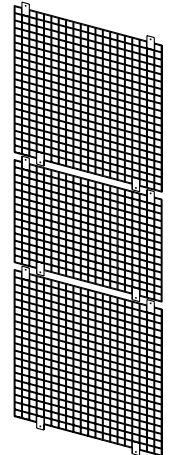

B Pallet Rack Upright with Security Panel

- Frames feature welded footplates
- 2" (51 mm) OC beam adjustment
- Hardware included in Pallet Rack Security Door
- Hardware Kit (PRSDHK-1, ordered separately)
- Mounting plates in Pallet Rack Security Door Hinge Hardware Kit (PRSDHHK, ordered separately)
- Standard finishes: Sahara or Blue Gray

PRUSP-(NH)

PRUSP Pallet Rack Upright with Security Panel
 NH Nominal Frame Height 120" or 168"
 (3048 mm or 4267 mm)



4 Pallet Rack Security Doors

- Secure merchandise by adding Pallet Rack Security Doors to either new or existing Pallet Rack systems
- Built of 2" x 2" (51 mm x 51 mm) wire grid
- Locking device supplied by customer
- Order the Pallet Rack Security Door Hinge Hardware Kit (PRSDHHK) and Pallet Rack Security Deck Hardware Kit (PRSDHK-1) to attach doors to Pallet Rack Frames (ordered separately)
- Standard finishes: Sahara or Blue Gray

PRSD2X2-(NW)(NH)(OPT)

PRSD2X2.... Pallet Rack Security Doors–
 2"x 2" (51 mm x 51 mm) Grid
 NW.... Nominal Width 48" or 96"
 (1219 mm or 2438 mm)
 NH.... Nominal Height 48", 72", 84", 96",
 108" or 120" (1219 mm, 1829 mm,
 2134 mm, 2438 mm, 2743 mm or 3048 mm)
 OPT.... Security Panel Option:
 Blank=With Security Panels
 NSP=No Security Panels

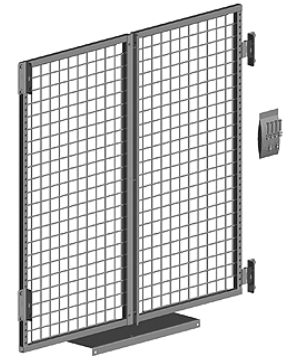

Shown with Hinge Kit (PRSDHHK)

5 Pallet Rack Security Door Hinge Hardware Kit

- Includes all necessary screws and hardware components required to fasten set of Pallet Rack Security Doors, Upper Deck, and Side Security
- Panels to Pallet Rack system
- Standard finishes: Sahara or Blue Gray

PRSDHHK

PRSDHHK.... Pallet Rack Security Door Hinge Hardware Kit

Contents	Quantity
Right-Hand Hinges	2
Left-Hand Hinges	2
Deck Securing Brackets	6
Connecting Plates	6

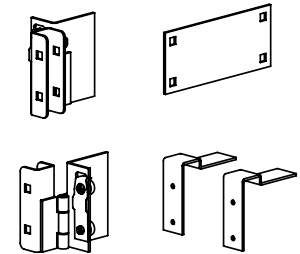

6 Pallet Rack Security Door Hardware Kit

- Includes assortment of nuts, bolts, and washers used to attach:
 - Pallet Rack Side Security Panel [PRSSP-(NH)(ND)]
 - Pallet Rack Security Doors [PRSD2X2-(NW)(NH)(OPT)] (without hinges)
 - Pallet Rack Upright with Security Panel [PRUSP-(NH)]
 - Pallet Rack Upper Security Deck [PRUSD-(NW)(ND)]

PRSDHK-1

PRSDHK-1.... Pallet Rack Security Door Hardware Kit



7 Pallet Rack Frame

- Frames feature welded footplates
- 2" (51 mm) OC beam adjustment
- Size availability to 48" (1219 mm) wide and 192" (4877 mm) high
- Allow minimum pallet overhang of 2" (51 mm) front and 2" (51 mm) rear when selecting frame size
- Standard finishes: Sahara or Blue Gray

PR2(TYPE)F(ND)(NH)

PR2.... Pallet Rack 2" (51 mm) OC
 TYPE.... HD=Heavy-Duty, RD=Regular-Duty
 F.... Frame
 ND.... Nominal Frame Depth 24" to 48" in 6" increments
 (610 mm to 1219 mm in 152 mm increments)
 NH.... Nominal Frame Height 72", 84", 96", 108", 120",
 132", 144", 168" or 192" (1829 mm, 2134 mm, 2438 mm,
 2743 mm, 3048 mm, 3353 mm, 3658 mm, 4267 mm
 or 4878 mm)

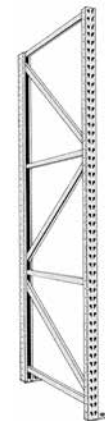

8 Pallet Rack Upper Security Deck

- Eliminate access to merchandise stored on Pallet Rack systems
- Security Deck is fastened to beams using hardware in the Pallet Rack Security Deck Hardware Kit (PRSDHK-1) (ordered separately)
- Brackets in Pallet Rack Security Door Hinge Hardware Kit (PRSDHHK, ordered separately)
- Standard finishes: Sahara or Blue Gray

PRUSD-(NW)(ND)

PRUSD.... Pallet Rack Upper Security Deck
 NW.... Nominal Width 72" or 96"
 (1829 mm or 2438 mm)
 ND.... Nominal Depth 24" to 48" in 6" increments
 (610 mm to 1219 mm in 152 mm increments)

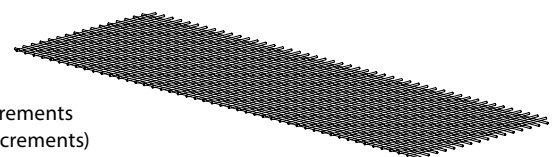

Suspended Maxi in Pallet Rack

Designed to merchandise pegged or shelved products in a Pallet Rack section, Suspended Maxi may be used in any section height greater than 72" (1829 mm) and with all beam lengths. The system is depth adjustable and accepts most Maxi Line accessories. Load capacity is 800 pounds.

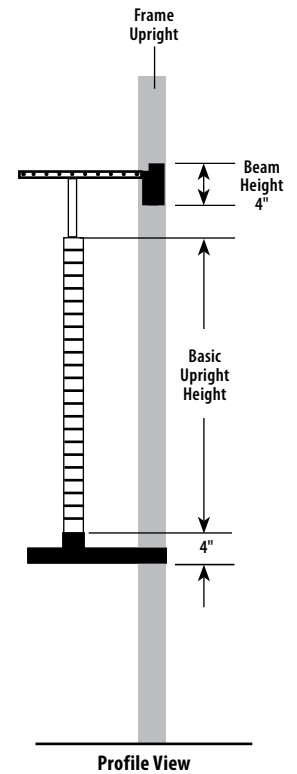
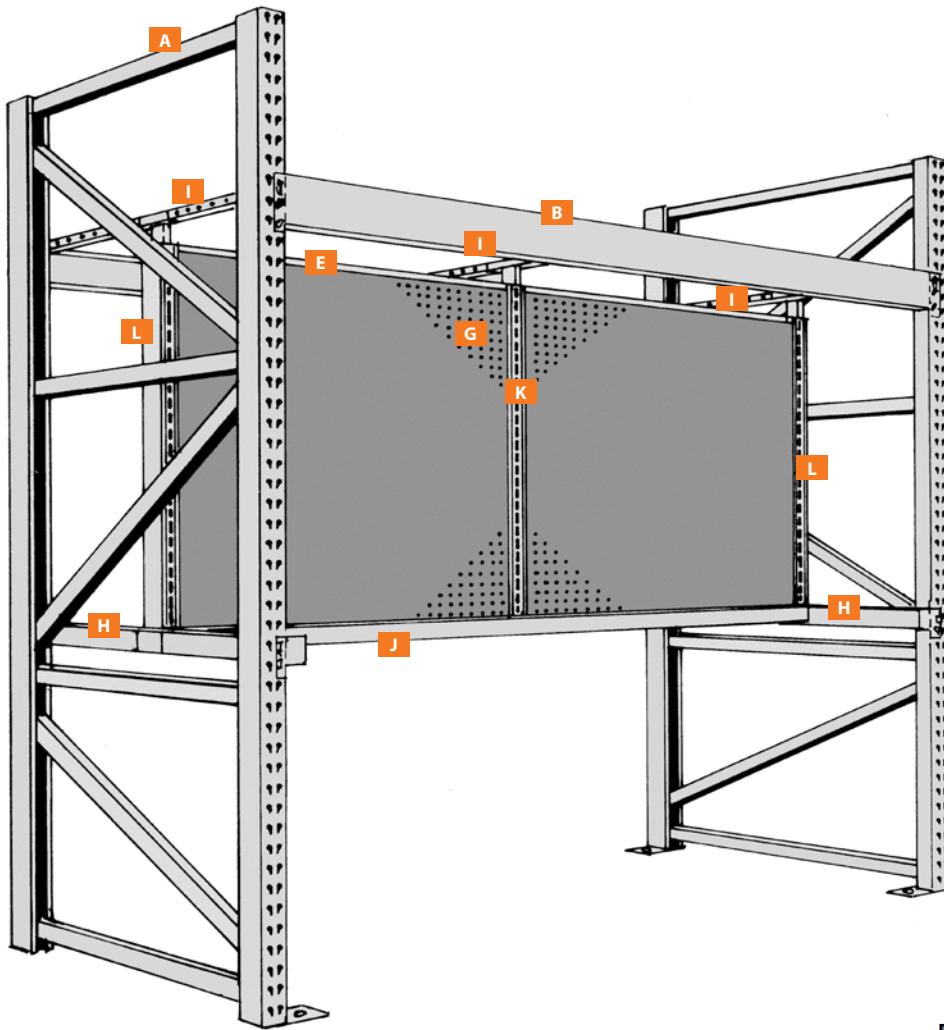

Description	Part Number	Qty.
A Pallet Rack Frames	PR2(TYPE)F(ND)(NH)	As Required
B Pallet Rack Beams	PR2B(NH)(NL)2	2
C* Pallet Rack Deck Supports	MPRDS-(ND)	As Required
D* Pallet Rack Decks	Various decks to choose from	As Required
E Top Spanner	STL-(NW)	4
F* Center Spanner	SC-(NW)	2
G Extension Back Panels, pegboard or hardboard	BX(TYPE)-(NW)(NH)	4
H Pallet Rack Basic Upright Support, frame depth	PRBUNDS-(ND)	1 Pair
I Basic Upright Support Bracket, Modified Omega	MOUSBO-(ND)-F	3
J Pallet Rack Basic Upright Support, beam length	PRBUNWS-(NL)	1
K Pallet Rack Basic Upright	PRBU-(NH)	1
L Pallet Rack Basic Upright, flush side	PRFSBU-(NH)	2
M* STL Clip	STLCLIP	1 Pair

*Not shown



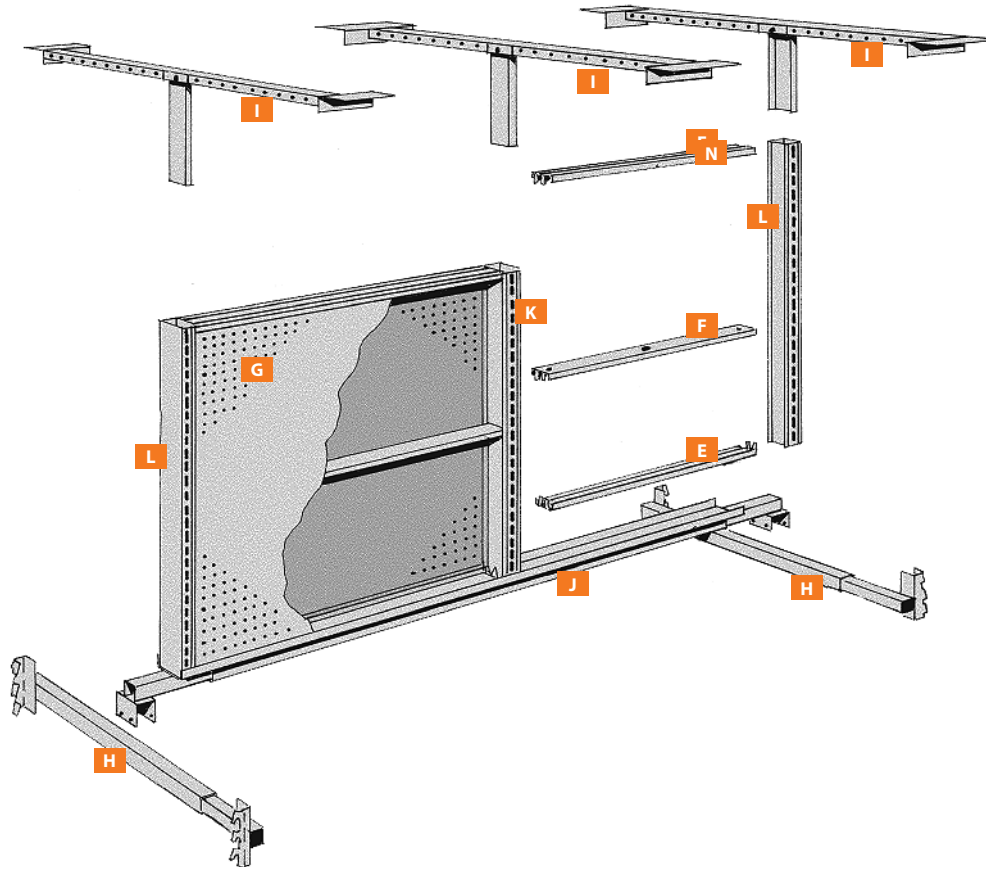

E STL-(NW)

STL Top Spanner
 NW Nominal Width 3' or 4' (914 mm or 1219 mm)
 • STL Clips installed with Top Spanners

F SC-(NW)

SC Center Spanner
 NW Nominal Width 3' or 4' (914 mm or 1219 mm)

G BX(TYPE)-(NW)(NH)

BX Extension Back
 TYPE P=Pegboard, H=Hardboard
 NW Nominal Width 3' or 4' (914 mm or 1219 mm)
 NH Nominal Extension Height 6" to 54" in 6" increments
 (152 mm to 1372 mm in 152 mm increments)

H PRBUNDS-(ND)

PRBUNDS....Pallet Rack Basic Upright Support
 ND....Nominal Depth 36" or 48" (914 mm or 1219 mm)
 • Pairs

I MOUSBO-(ND)-F

MOUSBO..Modified Omega Basic Upright Support Offset
 ND Nominal Depth 36" or 48" (914 mm or 1219 mm)
 F Floating

J PRBUNWS-(NL)

PRBUNWS...Pallet Rack Basic Upright Supports, Beam Length
 NL....Nominal Length 48", 72" or 96"
 (1219 mm, 1829 mm or 2438 mm)

K PRBU-(NH)

PRBUPallet Rack Basic Upright
 NH....Nominal Height 24", 30" or 36"
 (610 mm, 762 mm or 914 mm)

L PRFSBU-(NH)

PRFSBUPallet Rack Basic Upright, Flush Side
 NH....Nominal Height 24", 30" or 36"
 (610 mm, 762 mm or 914 mm)

M* STLCLIP

STLCLIPTop Spanner Clip
 • One pair secures Top Spanner (STL-(NW))

**Not shown*

NOTE!

Order the required number of backs for designated units; order separately Hardboard BXH-(NW)(NH) or Pegboard BXP-(NW)(NH)

Pallet Rack Roll Goods Display

Rigid, super-strong display for large rolls or spools of rope, chain, wire, or screening. May be used with or without decks (as shown) for reserve stock.

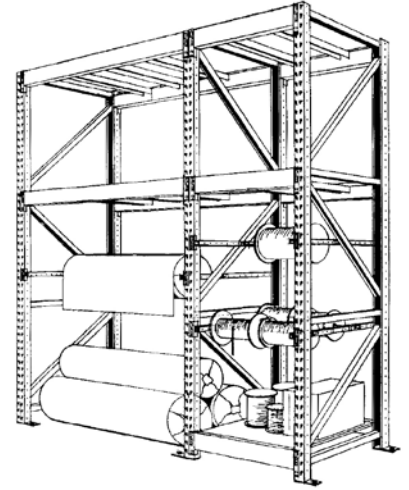

Pallet Rack Center Support Arm

- Telescoping feature shown; allows crossbar to slip easily into upright slots on both sides of frame
- Dart clips lock crossbar in place
- Provides ccross-frame support for roll-goods tube and tube holder

PRCSA-(NW)

PRCSA Pallet Rack Center Support Arm
 NW Nominal Width 24", 30", 36", 42" or 48"
 (610 mm, 762 mm, 914 mm, 1067 mm or 1219 mm)



Pallet Rack Roll Goods Tube Holder

- For mass display of roll goods
- Accommodates all roll good tubes
- Fits over and bolts to center support arms

HMRGTH

HMRGTH... Pallet Rack Roll Goods Tube Holder

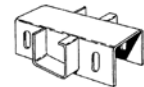

Pallet Rack Roll Goods Tube

- 1" (25 mm) OD galvanized tubing
- Longer tube lengths are not recommended for numerous heavy spools, rolls of chain, or large rolls of flooring
- Check diameter of spindle hole on spools prior to ordering

PRRGT-(NW)

PRRGT Pallet Rack Roll Goods Tube
 NW Nominal Width 24", 30", 36", 42" or 48"
 (610 mm, 762 mm, 914 mm, 1067 mm or 1219 mm)



Pallet Rack Heavy-Duty Cantilever End Shelf Frame

- Allows display of product on end of pallet rack runs
- Can be mounted to pallet rack to display above pallets of boxed product
- Requires Pallet Rack Heavy-Duty Cantilever End Shelf Deck, ordered same size as End Shelf Frame

PR2HDFCESFA(NW)(ND)

PR2 Pallet Rack 2" (51 mm) OC
 HD Heavy-duty
 FCESFA Frame Cantilever End Shelf Frame
 NW Nominal Width 24" (610 mm)
 ND Nominal Depth 16" (406 mm)

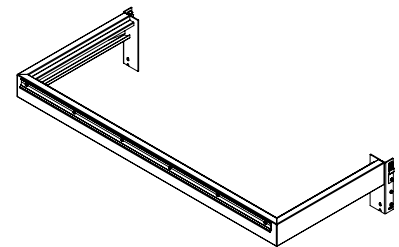

Pallet Rack Heavy-Duty Cantilever End Shelf Deck

- For use with Pallet Rack Heavy-Duty Cantilever End Shelf Frame, ordered same size

PR2HDFCESD(NW)(ND)(OPT)

PR2 Pallet Rack 2" (51 mm) OC
 HD Heavy-duty
 FCESD Frame Cantilever End Shelf Deck
 NW Nominal Width 24" (610 mm)
 ND Nominal Depth 16" (406 mm)
 U Unsealed

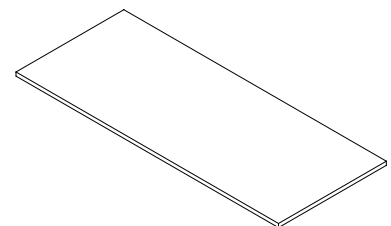



Create a perfectly stocked Pallet Rack shelf instantly with @Front! @Front incorporates multiple small, rolling tracks that work with gravity to automatically feed merchandise to front of shelf, cutting time and labor necessary for store merchandising and facing. Metal dividers can be easily adjusted in mere seconds, accommodating bottled, canned, and boxed goods of varying size and shape. Rolling-track system is fully integrated with the shelf itself, little to no maintenance required. Simply remove the entire shelf for a thorough wash, or wipe the rollers with a damp cloth to remove light dust and debris. Unique, patented design uses all plastic construction, allowing roller replacement from top surface (spare rollers integrated into bottom of every shelf). 5° downtilt improves sight lines for better visual impact than other gravity feed systems. Replaces cumbersome, spring pusher systems.

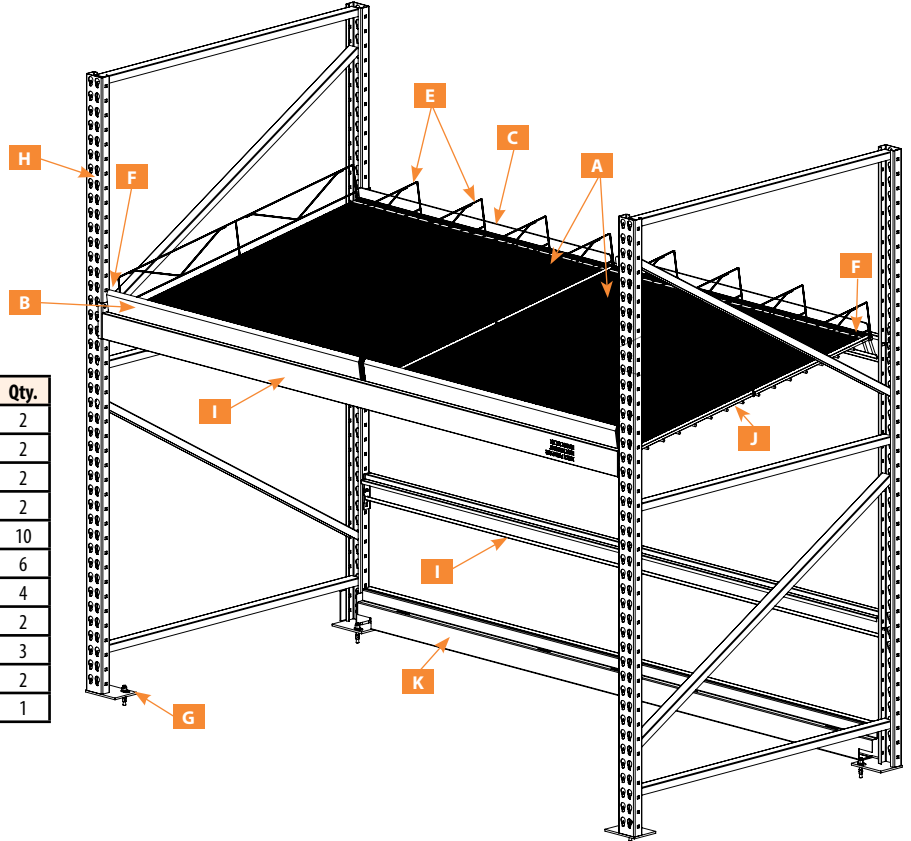

Description	Part Number	Qty.
A @Front Roller Mat, Black	AFRSPR4747-BLK	2
B @Front Roller Shelf Plastic Front, 48"W x 4"H	AFRSPF(NH)(NW)H	2
C @Front Roller Shelf Plastic Front, 48" W x 2"H	AFRSPF(NH)(NW)	2
D* Roller Shelf Offset Front Stop	RSFSFPRWS(NW)(OPT)	2
E @Front Wire Dividers	AFRSWD547	10
F Wide Span Dart Clip	WSDC25-1	6
G Seismic Floor Anchor Expansion Bolt	SFA-EB-1	4
H Pallet Rack Frames, Regular-Duty	PR2(OPT)F(ND)(NH)	2
I Wide Span Gravity Feed Beam	WSGFB-(NW)-(OPT)	3
J Gravity Feed Wire Deck	HMGFWD-480648	2
K Pallet Rack Beam	PR2B(NH)(NW)-2	1

*Not shown

A @Front Roller Mat

- Mats are 4' wide (1219 mm) and come in two pieces that are 28 1/2" and 18 1/2" (724 mm and 470 mm)

AFRSPR4747-BLK

AFRSPR....@Front Roller Mat
 47....Nominal Width 48" (1219 mm)
 47....Nominal Depth 48" (1219 mm)
 BLK....BLK=Black



B @Front Shelf Plastic Front, Heavy-Duty

- 3" (76 mm) heavy-duty, plastic fronts
- 3" (76 mm) installed height of 2 7/8" (73 mm)
- Slight bend at the top of the Plastic Front is to face the rear of the shelf
- Fronts can be used with refrigeration, Heavy-Duty, Maxi Line and Gen5 Roller Systems

AFRSPF(NH)(NW)H

AFR....@Front
 SPF....Shelf Plastic Front
 NH....Nominal Height 3"
 (76 mm or 102 mm)
 NW....Nominal Width 36" or 48"
 (914 mm or 1219 mm)
 H....Heavy-Duty

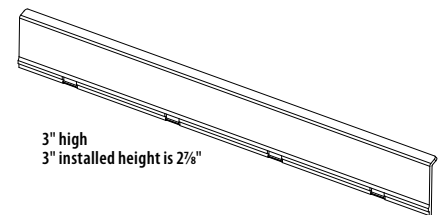

C @Front Shelf Plastic Front

- 2" (51 mm) installed height of 1½" (38 mm)
- Fronts can be used with refrigeration, Heavy-Duty, Maxi Line, and Gen5 Roller Systems

AFRSPF(NH)(NW)

AFR @Front
 SPF Shelf Plastic Front
 NH Nominal Height 2"
 (51 mm)
 NW Nominal Width 36"
 (914 mm)

2" Front installed height is 1½"

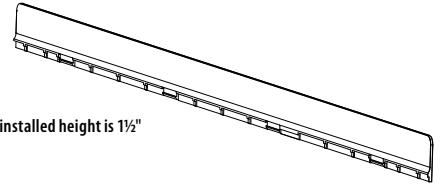
**D @Front Roller Shelf Offset Front Stop for Pallet Rack**

- Between inside wall of beam and @Front Roller Shelf
- Two per 8' (2438 mm) section
- Optional heavy-duty available

RSFSFPRWS(NW)(OPT)

RSFS Roller Shelf Front Stop
 FPRWS for Pallet Rack and Wide Span
 NW Nominal Width 48" (1219 mm)
 OPT HD=Heavy-duty

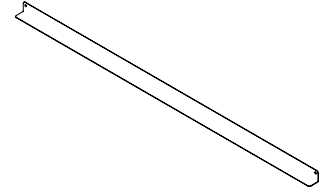
**E @Front Roller Shelf Wire Divider****AFRSWD547**

AFRS @Front Roller Shelf
 WD Wire Divider
 5 Nominal Height 5" (127 mm)
 47 Nominal Width 48" (1194 mm)

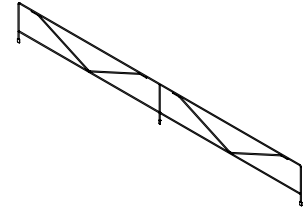
**@Front Roller Shelf Divider with Pusher Shelf**

- For Pallet Rack application, ensuring very light merchandise (e.g. single paper towel rolls,) is fronted without manual effort
- 6 pack only

AFRSWDPUSH547-6PK

AFRS @Front Roller Shelf
 WD Metal Divider
 PUSH Pusher
 5 Nominal Height 5" (127 mm)
 47 Nominal Width 48" (1194 mm)
 6PK 6 Pack

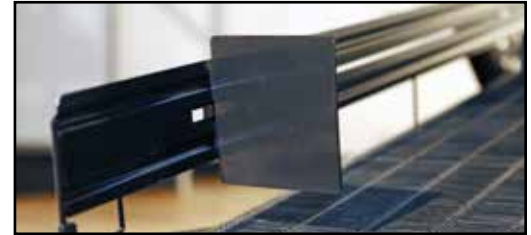
**F Wide Span Dart Clip**

- Spring steel clip secures beam to frame, preventing accidental disengagement
- Two required per beam

WSDC25-1

WSDC Wide Span Dart Clip
 25 Thickness .250" (6 mm)
 1 1=1 Pack

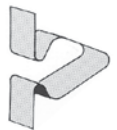
**G Seismic Floor Anchor Expansion Bolts**

- ICBO approved
- ¾"-16 x 3½"
- Order two bolts per Seismic Floor Anchor (Regular or Heavy-Duty)

SFA-EB-1

SFA Seismic Floor Anchor
 EB Expansion Bolt
 1 1 Pack

**H Pallet Rack Frame**

- Regular-duty and heavy-duty Frames used available (regular-duty Frame shown in adjacent image)
- Frames feature welded footplates
- 2" (51 mm) OC beam adjustment
- Size availability to 48" (1219 mm) wide and 144" (3658 mm) high
- Allow minimum pallet overhang of 2" (51 mm) front and 2" (51 mm) rear when selecting frame size
- Standard finishes: Sahara or Blue Gray

PR2(OPT)F(ND)(NH)

PR2 Pallet Rack 2" (51 mm) OC
 OPT HD=Heavy-Duty, RD=Regular-Duty
 F Frame
 ND Nominal Frame Depth 24" to 48" in 6" increments
 (610 mm to 1219 mm in 152 mm increments)
 NH Nominal Frame Height 72", 84", 96", 108", 120", 132" or 144"
 (1829 mm, 2134 mm, 2438 mm, 2743 mm, 3048 mm, 3353 mm or 3658 mm)

**NOTE!**

To preclude overturning, the frame depth x 6 cannot exceed height of topmost loaded beam pair, unless all the frames are properly anchored or braced externally.

Wide Span Gravity Feed Beam

- Regular-duty and heavy-duty Beams available

WSGFB-(NW)-(OPT)

- WS Wide Span
- GFB Gravity Feed Beam
- NW Nominal Width 36", 42", 48", 60", 72", 84" or 96"
(914 mm, 1057 mm, 1219 mm, 1524 mm, 1829 mm, 2134 mm or 2438 mm)
- OPT RD=Regular-Duty
HD=Heavy-Duty

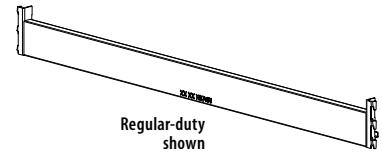

Gravity Feed Wire Deck

- Wire-grid angled deck

HMGFWD-480648

- HM Hypermaxi
- GFWD Gravity Feed Wire Deck
- 48 Nominal Depth 48" (1219 mm)
- 06 Beam Drop 6" (152 mm)
- 48 Nominal Width 48" (1219 mm)



Pallet Rack Beam

- Available in three heights for differing load capacities
- Step depth accommodates 2" (51 mm) dimensional lumber decking, or wire decking
- Beams are slotted in step to accept deck supports under decking
- Standard finishes: Sahara or Blue Gray

PR2B(NH)(NW)-2

- PR2 Pallet Rack 2" (51 mm) OC
- B Beams
- NH Nominal Beam Height
 - 35=3½" (89 mm)
 - 50=5" (127 mm)
 - 60=6" (152 mm)
- NW Nominal Width 36", 48", 60", 72", 84", 96", 108", 120", 132" or 144"
(914 mm, 1219 mm, 1524 mm, 1829 mm, 2134 mm, 2438 mm, 2743 mm, 3048 mm, 3353 mm or 3658 mm)
- 2 Step 2 Only

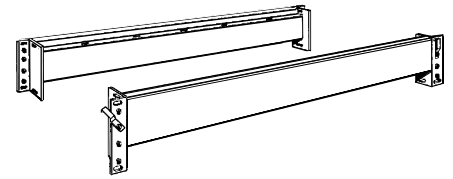

Wide Span

Finished units are extremely rigid, eliminating back and side sway, and no assembly hardware means rapid installation. Frames, beams, and deck supports are fabricated from heavy-gauge steel finished in Blue Gray or Sahara. Decks are 5/8" (16 mm) particle board.

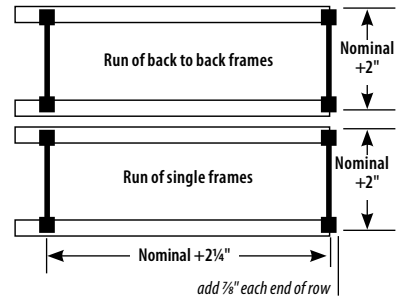
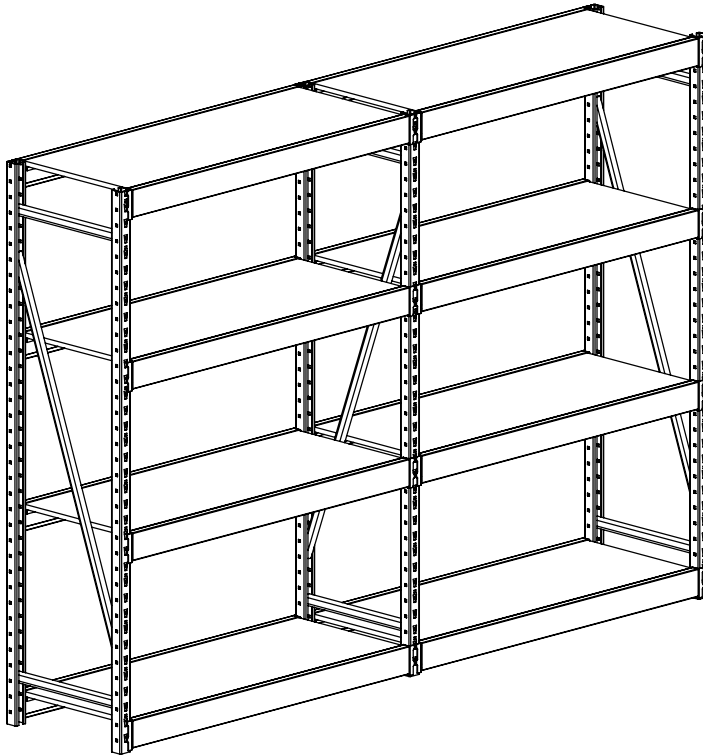

Beam Loading

Maximum Load Capacity per Beam Pair

Beam Length	Light-Duty	Regular-Duty	Heavy-Duty	Number of Supports for Wood Decks	Number of Supports for Wire Decks
48"	1000 #	1600 #	3000 #	2	2
60"	1000 #	1600 #	3000 #	3	4
72"	1000 #	1600 #	3000 #	3	4
84"	1000 #	1600 #	3000 #	3	4
96"	1000 #	1600 #	3000 #	3	4

Based on evenly distributed loads and 96" beam length, all frame widths

Wide Span Frame Loading

- Frame loading is the vertical load, measured in pounds, that can be applied on any frame
- Each frame bears one-half of the load of each beam pair that it supports
- All frames have 10,000 lb load capacity

NOTE!
Powered fork trucks on stackers are not recommended for use on Wide Span Shelving.

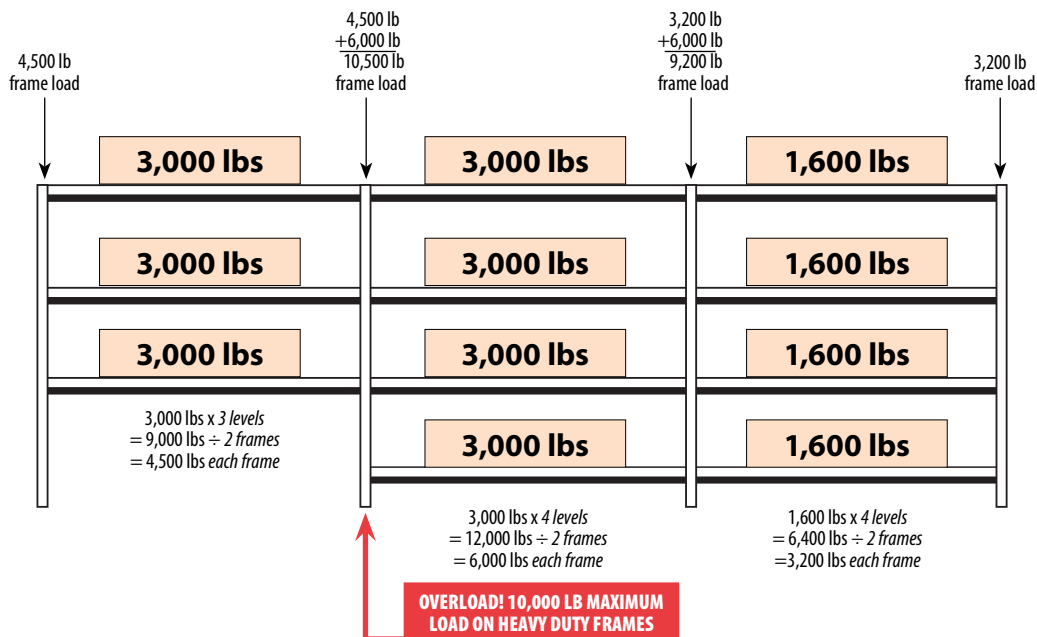

Wide Span Frame

- Heavy-gauge, 1 3/4" (44 mm), square, upright members with welded cross braces are slotted
- 2" (51 mm) OC for adjustability
- Heavy-Duty Frame has additional bracing to resist accidental stacker impact
- Top beam fits flush to top of frame
- Requires a minimum of two decks and four beams per section
- Standard finishes: Sahara or Blue Gray

(TYPE)WSF(ND)(NH)-(OPT)

TYPE RD=Regular-Duty
 HD=Heavy-Duty
 WSF Wide Span Frame
 ND Nominal Frame Depth
 18" to 48" in 6" increments
 (457 mm to 1219 mm in 152 mm increments)
 NH Nominal Frame Height
 48" to 120" in 12" increments
 (1219 mm to 3048 mm in 305 mm increments)
 OPT Blank=as shown
 FA=Floor Anchor

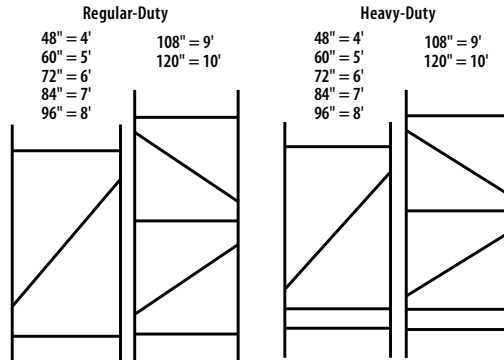
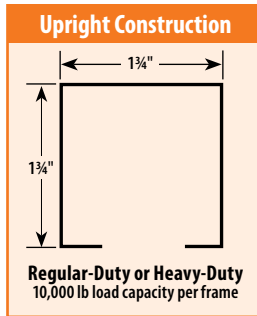
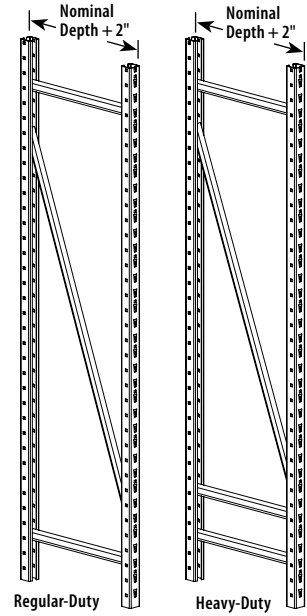

NOTE!
 To preclude overturning, the frame depth x 6 cannot exceed height of topmost loaded beam pair, unless all the frames are properly anchored or braced externally.

Wide Span Beam

- Heavy gauge beam body with integral connectors fits snugly into upright slots and maintains deck alignment with basic fixture slotting
- One beam pair required per deck
- Wide Span Decks ordered separately
- Standard finishes: Sahara or Blue Gray

(TYPE)WSFB(NL)

TYPE LD=Light-Duty
 RD=Regular-Duty
 HD=Heavy-Duty
 WSFB Wide Span Front Beam
 NL Nominal Length
 48" to 96" in 12" increments
 (1219 mm to 2438 mm in 305 mm increments)

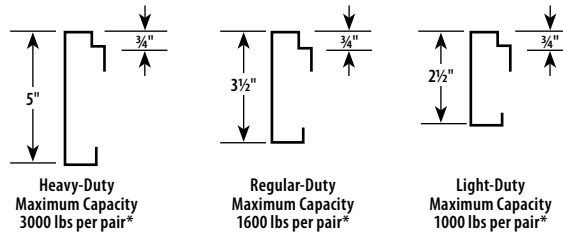
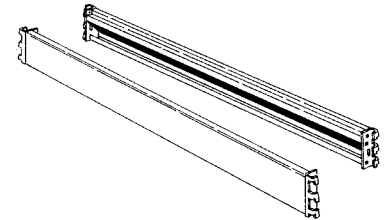

*Based on evenly distributed loads, 96" beam lengths, all frame lengths

Regular-Duty Wide Span Front Beam with Tag Molding

- Optional Tag Molding for Regular-Duty Wide Span Front Beams only
- Molding is pop-riveted on to beam:
 - Standard tag position is center of beam
 - Upper tag position is 3/8" (10 mm) from top of beam
 - Flush tag position is top of beam

RDWSFB(NW)-(U)-(TAG)-(UD)-(FT)

RDWSFB Regular-Duty Wide Span Front Beam
 NW Nominal Width
 36" to 96" in 12" increments
 (914 mm to 2438 mm in 305 mm increments)
 U U=Upper
 Blank=Standard
 TAG DGA or M17 and Color
 UD UD=Upside Down Tag
 Blank=Right Side Up Tag
 FT Flush Top Tag
 Blank=Standard

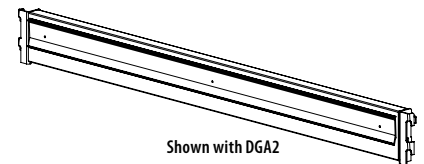

Wide Span Top Cap

- Clear plastic cap inserts into top of upright
- Allows beam to be mounted in top slot of upright

WSTC-1-CL

WSTC Wide Span Top Cap
 1 1=1 Pack
 CL Clear Plastic

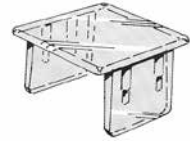

Wide Span Dart Clip

- Spring steel clip secures beam to frame, preventing accidental disengagement
- Two required per beam

WSDC25-50

WSDC Wide Span Dart Clip
 25 Thickness .250" (6 mm)
 50 50= 50 Pack

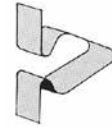

Wide Span Deck Support

- Formed steel component easily rotates into place, ties beams together, and supports deck
- Standard finishes: Sahara or Blue Gray

(TYPE)WSDS(ND)

TYPE LD=Light-Duty
 RD=Regular-Duty
 HD=Heavy-Duty
 WSDS Wide Span Deck Support
 ND Nominal Depth 18" to 48" in 6" increments
 (457 mm to 1219 mm in 152 mm increments)

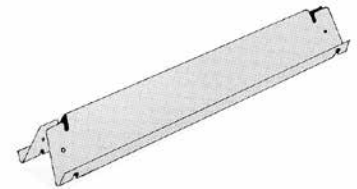

Deck Supports per Beam Length		
Beam Length	Supports for Wood Decks	Supports for Wire Decks
48"	2	2
60" to 72"	3	4
84" to 96"	3	4

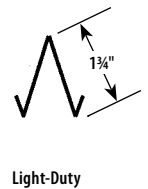
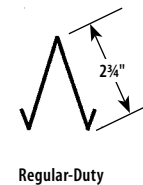
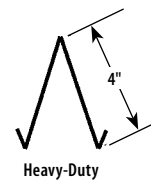

Wide Span Deck Support, Economy

- Formed steel component easily rotates into place, ties beams together and supports deck
- Galvanized finish only

RDWSDSE(ND)

RD Regular-Duty
 WSDS Wide Span Deck Support
 E Economy
 ND Nominal Depth 18" to 48" in 6" increments
 (457 mm to 1219 mm in 152 mm increments)

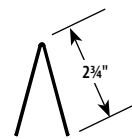
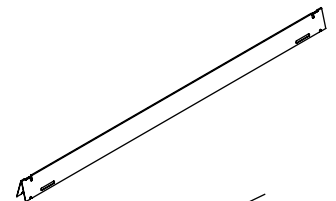

Deck Supports per Beam Length		
Beam Length	Supports for Wood Decks	Supports for Wire Decks
48"	2	2
60" to 72"	3	4
84" to 96"	3	4

Wide Span Deck

- Regular-Duty Decks are durable 5/8" (16 mm) particle board
- Heavy-Duty Decks are 5/8" (16 mm), 45 lb density particle board for increased load capacity

(TYPE)WSD(ND)(NL)-U

TYPE RD=Regular-Duty
 HD=Heavy-Duty
 WSD Wide Span Deck
 ND Nominal Frame Depth
 18" to 48" in 6" increments
 (457 mm to 1219 mm in 152 mm increments)
 NL Nominal Frame Length
 48" to 96" in 12" increments
 (1219 mm to 2438 mm in 305 mm increments)
 U Unsealed

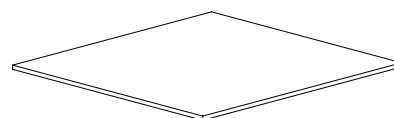

Wide Span Deck Kit, Wire Grid

- Deck Kit includes two beams, correct number of deck supports, plus one deck for ease of ordering; deck kits over 48" (1219 mm) in length, two decks are included
- One kit required per level of shelving
- Dart Clips for beam locking are not included; four Wide Span Dart Clips (WSDC25-50) are required per kit
- Sturdy wire, 5/16" (8 mm) gauge in diameter, is welded on 3" (76 mm) grid centers
- 3" x 3" (76 mm x 76 mm) is one piece up to 96" (2438 mm) wide
- Standard finishes for Wire Grid: Silver Vein, Sahara and Blue Gray
- Standard finishes for metal components: Sahara or Blue Gray

(TYPE)WSK(ND)(NL)-WG

- TYPE LD=Light-Duty
RD=Regular-Duty
HD=Heavy-Duty
- WSK Wide Span Deck Kit
- ND Nominal Frame Depth
18" to 48" in 6" increments
(457 mm to 1219 mm in 152 mm increments)
- NL Nominal Frame Length
48" to 96" in 12" increments
(1219 mm to 2438 mm in 305 mm increments)
- WG Wire Grid

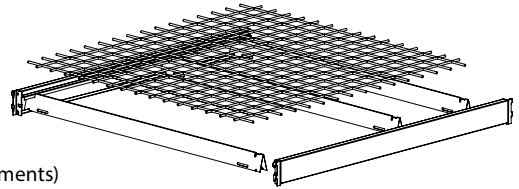

Maximum Load Capacity per Beam Pair					
Type of Deck Supports	Beam Length				
	48"	60"	72"	84"	96"
Light-Duty	1000#	1000#	1000#	1000#	1000#
Regular-Duty	1600#	1600#	1600#	1600#	1600#
Heavy-Duty	3000#	3000#	3000#	3000#	3000#
# of Deck Supports	2	4	4	4	4

Based on evenly distributed loads and 96" length beam, all frame widths

Wide Span Deck Kit

- Deck Kit includes two beams, correct number of deck supports, plus one deck for ease of ordering
- One kit required per level of shelving
- Dart Clips for Beam locking are not included, four Wide Span Dart Clips (WSDC25-50) are required per kit
- Regular-duty uses economy deck supports
- Standard finishes for metal components: Sahara or Blue Gray

(TYPE)WSK(ND)(NL)-U

- TYPE LD=Light-Duty
RD=Regular-Duty
HD=Heavy-Duty
- WSK Wide Span Deck Kit
- ND Nominal Frame Depth
18" to 48" in 6" increments
(457 mm to 1219 mm in 152 mm increment)
- NL Nominal Frame Length
48" to 96" in 12" increments
(1219 mm to 2438 mm in 305 mm increments)
- U Unsealed

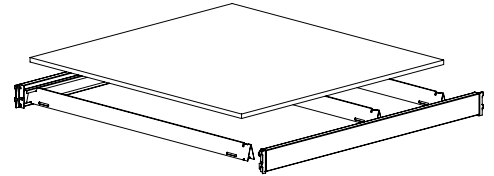

Maximum Load Capacity per Beam Pair					
Type of Deck Supports	Beam Length				
	48"	60"	72"	84"	96"
Light-Duty	1000#	1000#	1000#	1000#	1000#
Regular-Duty	1600#	1600#	1600#	1600#	1600#
Heavy-Duty	3000#	3000#	3000#	3000#	3000#
# of Deck Supports	2	3	3	3	3

Based on evenly distributed loads and 96" length beam, all frame widths

NOTE!
Substitute -S for -U in part number, add \$2.00 per deck.

Wide Span Wire Grid Deck

- Sturdy 5/16" (8 mm) diameter gauge wire welded on 3" (76 mm) grid centers
- Deck Supports are NOT included; order per chart
- 3" x 3" (76 mm x 76 mm) is one piece up to 96" (2438 mm) wide
- Standard finishes: Silver Vein, Sahara and Blue Gray
- Suggested finish is Silver Vein, a black/silver combination coating that is highly resistant to abrasion and retains original appearance despite hard usage

WSWMS(ND)(NL)-3

- WS Wide Span
- WMS Wire Grid Deck
- ND Nominal Frame Depth 18" to 48" in 6" increments
(457 mm to 1219 mm in 152 mm increments)
- NL Nominal Frame Length 24" to 96" in 6" increments
(610 mm to 2438 mm in 152 mm increments)
- 3 Grid Size 3" OC (76 mm)



Wire grid piece length runs parallel to beam length

Nominal Beam Length	Required Quantity of Deck Supports
36"	2
48"	2
60"	4
72"	4
84"	4
96"	4

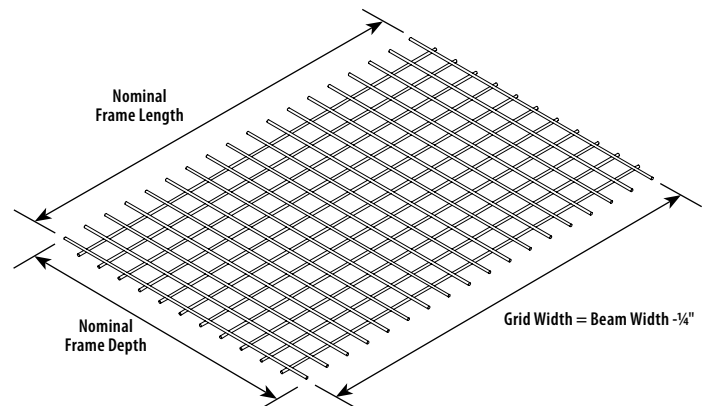

Flow Through Wide Span Deck

- Flow Through Wide Span Decks are pieced for ease of handling
- Sturdy wire, 5/16" (8 mm) gauge in diameter, is welded on 3" (76 mm) grid centers
- Deck Supports are NOT included; order per chart
- Standard finishes: Silver Vein, Sahara and Blue Gray

FTWSD-(ND)(NL)

- FT Flow Through
- WSD Wide Span Deck
- ND Nominal Frame Depth
18" to 48" in 6" increments
(457 mm to 1219 mm in 152 mm increments)
- NL Nominal Piece Length
24" to 48" in 6" increments
(610 mm to 1219 mm in 152 mm increments)



Wire grid piece length runs parallel to beam length

Deck Type	Nominal Beam Length	Combine these Piece Lengths to equal Beam Length	Required Quantity of Deck Supports
One-Piece Decks	36"	36"	2
	48"	48"	2
Two-Piece Decks	60"	30" + 30"	4
	72"	36" + 36"	4
	84"	42" + 42"	4
	96"	48" + 48"	4

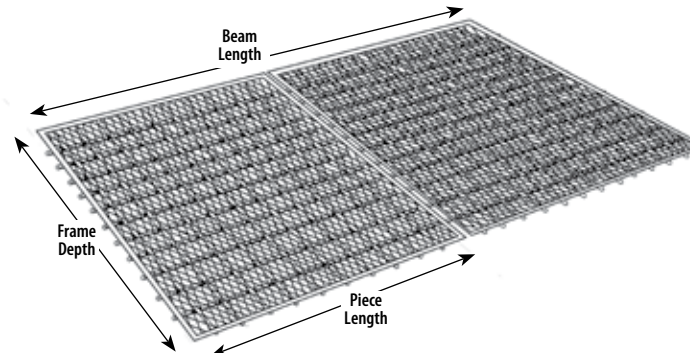

Sample Metal Grid Pattern

Frame Depth x Piece Length	Actual Frame Depth x Actual Piece Length	Frame Depth x Piece Length	Actual Frame Depth x Actual Piece Length
18" x 24"	17 3/4" x 23 3/4"	36" x 24"	35 3/4" x 23 3/4"
18" x 36"	17 3/4" x 35 3/4"	36" x 36"	35 3/4" x 35 3/4"
18" x 48"	17 3/4" x 47 3/4"	42" x 24"	41 3/4" x 23 3/4"
24" x 24"	23 3/4" x 23 3/4"	42" x 36"	41 3/4" x 35 3/4"
30" x 30"	29 3/4" x 29 3/4"	42" x 42"	41 3/4" x 41 3/4"
24" x 48"	23 3/4" x 47 3/4"	42" x 48"	41 3/4" x 47 3/4"
30" x 24"	29 3/4" x 23 3/4"	48" x 24"	47 3/4" x 23 3/4"
30" x 36"	29 3/4" x 35 3/4"	48" x 36"	47 3/4" x 35 3/4"
30" x 48"	29 3/4" x 47 3/4"	48" x 48"	47 3/4" x 47 3/4"

Wide Span Low Profile Metal Deck

- Metal Decks run perpendicular to beams
- Decks not affected by moisture; will not absorb spills
- Deck Supports are NOT included; order per chart
- Standard finishes: Sahara and Blue Gray

WSLPM06(ND)

- WS Wide Span
- LPM06 Low Profile Metal Deck
- 06 6" wide slat
- ND Nominal Frame Depth
18" to 36" in 6" increments
(457 mm to 914 mm in 152 mm increments)

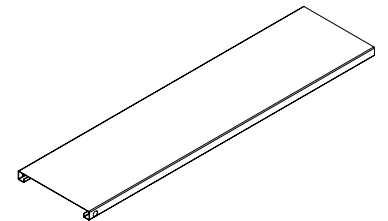

Maximum Load Capacity per Beam Pair					
Type of Deck Supports	Beam Length				
	48"	60"	72"	84"	96"
Light-Duty	1000#	1000#	1000#	1000#	1000#
Regular-Duty	1600#	1600#	1600#	1600#	1600#
Heavy-Duty	3000#	3000#	3000#	3000#	3000#
# of Deck Supports	2	3	3	4	4
# of Metal Decks	8	10	12	14	16

Based on evenly distributed loads and 96" length beam, all frame widths

Wide Span Wire Grid Deck, 1 x 6

- Wire Grid Decks are pieced for ease of handling
- Sturdy wire, 5/16" (8 mm) gauge in diameter, is welded on 1" x 6" (25 mm x 152 mm) grid centers
- Deck Supports are NOT included; order per chart
- Standard finishes: Silver Vein, Sahara and Blue Gray

Deck Supports per Beam Length	
Beam Length	Supports
48"	2
54" to 72"	3
84" to 96"	4

WSWMS(ND)(NL)-16

- WS Wide Span
- WMS Wire Grid Deck
- ND Nominal Frame Depth
20", 22", 24", 30" or 36"
(508 mm, 559 mm, 610 mm, 762 mm or 914 mm)
- NL Nominal Piece Length
30", 36", 48", 60", 72", 84" or 96"
(762 mm, 914 mm, 1219 mm, 1524 mm, 1829 mm, 2134 mm or 2438 mm)
- 16 1"x 6" Grid

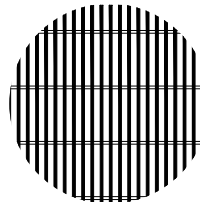

Sample Metal Grid Pattern

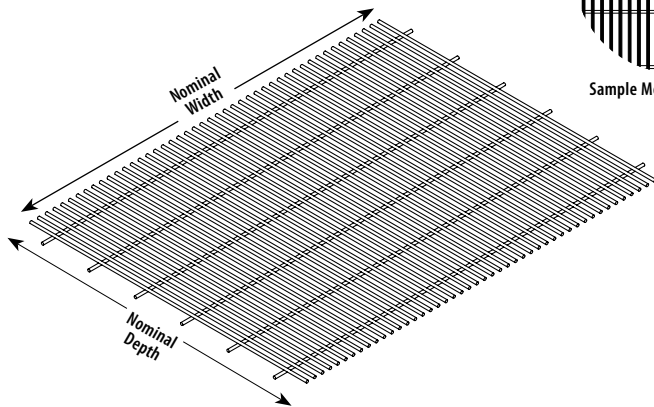

Frame Depth x Piece Length	Actual Frame Depth x Actual Piece Length	Frame Depth x Piece Length	Actual Frame Depth x Actual Piece Length
20" x 36"	19 3/4" x 36"	24" x 72"	23 3/4" x 72"
20" x 48"	19 3/4" x 48"	24" x 84"	23 3/4" x 84"
20" x 60"	19 3/4" x 60"	24" x 96"	23 3/4" x 96"
20" x 72"	19 3/4" x 72"	30" x 36"	29 3/4" x 36"
20" x 84"	19 3/4" x 84"	30" x 48"	29 3/4" x 48"
20" x 96"	19 3/4" x 96"	30" x 60"	29 3/4" x 60"
22" x 36"	21 3/4" x 36"	30" x 72"	29 3/4" x 72"
22" x 48"	21 3/4" x 48"	30" x 84"	29 3/4" x 84"
22" x 60"	21 3/4" x 60"	30" x 96"	29 3/4" x 96"
22" x 72"	21 3/4" x 72"	36" x 36"	35 3/4" x 36"
22" x 84"	21 3/4" x 84"	36" x 48"	35 3/4" x 48"
22" x 96"	21 3/4" x 96"	36" x 60"	35 3/4" x 60"
24" x 36"	23 3/4" x 36"	36" x 72"	35 3/4" x 72"
24" x 48"	23 3/4" x 48"	36" x 84"	35 3/4" x 84"
24" x 60"	23 3/4" x 60"	36" x 96"	35 3/4" x 96"

Wide Span Waterfall Grid Deck

- Wire Grid Decks are pieced for ease of handling
- Sturdy wire, 5/16" (8 mm) gauge in diameter, is welded on 3" x 3" (76 mm x 76 mm) grid centers
- Integrated deck supports eliminate standard deck supports
- Standard finishes: Silver Vein, Sahara and Blue Gray

WSWFGD-(ND)(NL)

- WS Wide Span
- WFGD Waterfall Grid Deck
- ND Nominal Frame Depth
18" to 48" in 6" increments
(457 mm to 1219 mm in 152 mm increments)
- NL Nominal Piece Length
24" to 48" in 6" increments
(610 mm to 1219 mm in 152 mm increments)

Nominal Beam Length	Combine these Piece Lengths to equal Beam Length
36"	36"
48"	48"
60"	30" + 30"
72"	36" + 36"
84"	42" + 42"
96"	48" + 48"
108"	36" + 36" + 36"
120"	36" + 48" + 36"
132"	48" + 36" + 48"
144"	48" + 48" + 48"

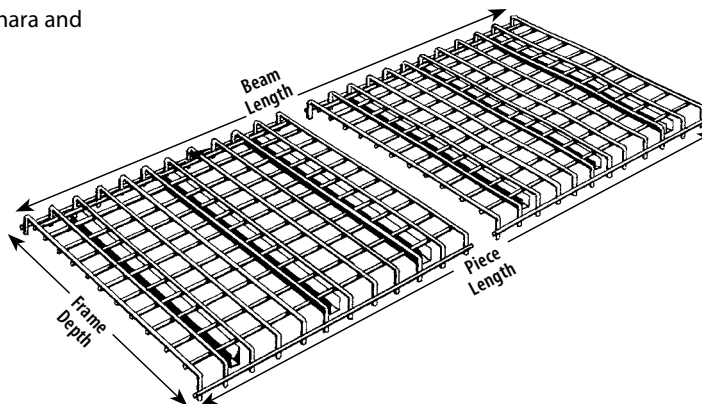

Deck Supports per Beam Length	
Beam Length	Supports
48"	2
54" to 72"	3
84" to 96"	4

Wide Span Frame Connectors

- Heavy-gauge channel with hardware for connecting any two frames, to obtain overall heights from 168" to 240" (4267 mm to 6096 mm)
- Available in packages of two only
- One package required for each frame
- Standard finishes for metal components: Sahara or Blue Gray

WSFC-2

- WSFC Wide Span Frame Connectors
- 2 2 Pack

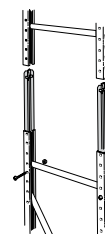

Wide Span Floor Anchor

- Heavy-gauge, galvanized-steel angle secures frame to floor
- Maintains aisle alignment and prevents tipping
- Hardware included to attach Wide Span Floor Anchor to Frame
- Concrete anchoring studs not included due to varying field conditions
- Galvanized finish only

WSFA-2

WSFA Wide Span Floor Anchor
2 2 Pack

NOTE!
Hole is sized for ½" floor anchors, order Pallet Rack Floor Anchor Kit (PRFAK-4).

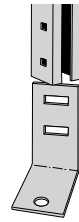

Wide Span Floor Anchor with Nut & Bolt

- Add a Floor Anchor Plate to a Wide Span Frame that does not have a footplate
- Can be added to a Wide Span Frame that has a footplate and the anchoring on either side of the Wide Span Upright
- Floor Anchor Bolts not included
Floor Anchors could keep beam being installed in the lowest slot on the Wide Span Upright
- Floor anchor might interfere with pallets and pallet jacks if no lower beam is used
- Galvanized finish only

WS-FANB

WS Wide Span
FANB Floor Anchor with Nut & Bolt

NOTE!
Need two hardware packs per frame.

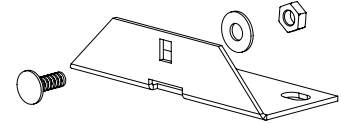

Wide Span Back-to-Back Connector

- Heavy-gauge-steel straps maintain 2" (51 mm) spacing between frames to allow repositioning of rear beams
- Hardware included for securing straps to frames
- Six connectors required for any height or combination of height frames
- Floor Anchor might interfere with pallets and pallet jacks if no lower beam is used
- Galvanized finish only

WSBBC-2-24

WSBBC-2 Wide Span Back-to-Back Connectors
24 24 Pack

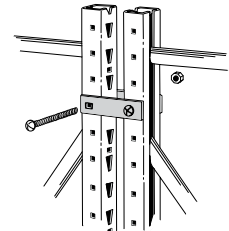

Wide Span Leveling Shim

- Galvanized ¼" (2 mm) shim has dimples to prevent dislodging from bottom of Upright Frame
- Use where floor protection is required or to level frames on uneven floors
- Galvanized finish only

WSLS-10

WSLS Wide Span Leveling Shim
10 10 Pack



Wide Span Back-to-Back Side Mount Rug Display Bar

- Displays rugs in a tiered fashion for better exposure
- Can be used to display taller products, long-handled tools, beach and patio umbrellas, or flag poles
- Crossbars create end caps, turning unused space into attention-getting displays
- Use 48" (1219 mm) bolted on 48" (1219 mm) single Wide Span
- Use 96" (2438 mm) bolted on 48" (1219 mm) back-to-back Wide Span

WSBBSMRD(NL)(ND)

WS Wide Span
BSMRD ... Back-to-Back Side Mount Rug Display Bar
NL Nominal Length 48" or 96"
(1219 mm or 2438 mm)
ND 04=4" (102 mm)
06=6" (152 mm)
08=8" (203 mm)

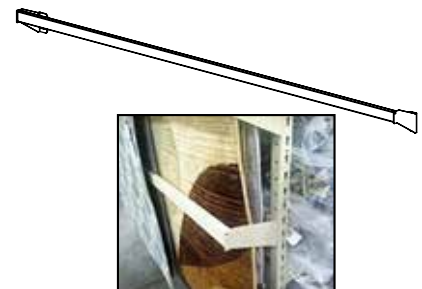

Recessed Pegboard Panel

- Framed pegboard panel for use with frame shown to merchandise blister pack and other pegged items within Wide Span section
- Increase impulse sales with cross merchandising
- Use combinations of panels for heights not listed
- Satin finish frame
- Standard finishes: Sahara or Blue Gray

RPP-(NW)(NH)

RPP Recessed Pegboard Panels
 NW Nominal Width
 4=48" or 8'=96"
 (1219 mm or 2438 mm)
 NH Nominal Height
 06" to 18" in 6" increments
 (152 mm to 457 mm in 152 mm increments)



Recessed Pegboard Panel Frame

- Frame assembly for use with Recessed Pegboard Panel
- Includes two brackets, reinforcing angle, and necessary hardware
- Two frames required per panel
- Recess depth shown is from front of Wide Span Upright
- Standard finishes: Sahara or Blue Gray

RF-(NW)(NH)

RF Recessed Pegboard Panel Frame
 NW Nominal Width
 4=48" or 8'=96"
 (1219 mm or 2438 mm)
 NH Nominal Height
 06" to 18" in 6" increments
 (152 mm to 457 mm in 152 mm increments)

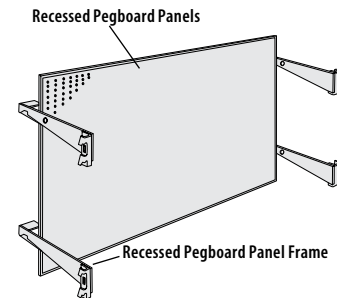

Wide Span Product Retainer

- The Wide Span Product Retainer has hooks to fit Wide Span Uprights, formed lower edge fits into beam step for security
- Two heights available; may be used with or without dividers
- Standard finishes: Sahara or Blue Gray

WSPR(NH)(NL)

WSPR Wide Span Product Retainer
 NH Nominal Height 3" or 6"
 (76 mm or 152 mm)
 NL Nominal Length 48" or 96"
 (1219 mm or 2438 mm)

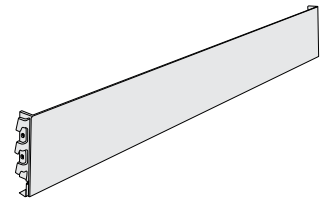

Wide Span Product Divider

- Formed metal divider freestands on particle board deck to allow binning
- Pre-punched to allow fastening to deck
- Two heights available, depths to match all Wide Span depths
- May be used in conjunction with Wide Span Product Retainer
- Standard finishes: Sahara or Blue Gray

WSPD-(NH)(NL)

WSPD Wide Span Product Divider
 NH Nominal Height
 3" or 6" (76 mm or 152 mm)
 NL Nominal Length
 18" to 48" in 6" increments
 (457 mm to 1219 mm in 152 mm increments)

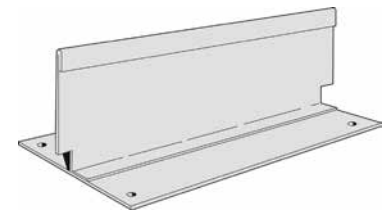

Wide Span End Frame Kick Plate

- Dresses up the end of the Wide Span Frames
- Install, as shown, at the base of the Wide Span Frame
- The Wide Span End Frame Kickplate [WSEFKP (ND)-(COLOR)] can also be installed at the top of the Wide Span Frame

WSEFKP(ND)-(COLOR)

WSEFKP Wide Span End Frame Kickplate
 ND Nominal Depth
 24", 30", 36", 46" or 48"
 (610 mm, 762 mm, 914 mm, 1168 mm or 1219 mm)
 COLOR B=Black
 DG=Dove Grey
 SA=Sahara

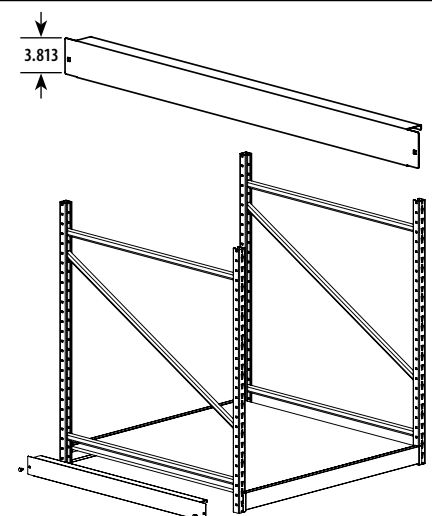

Wide Span Molding Rack Beams

- Add Molding Rack Beams and Vertical Divider Arms to standard Wide Span Frames to create an attractive Molding Rack
- Beam Kits include top, middle, bottom and front beams
- Mount front beam one slot higher than rear beam for a sloped deck; adding a front retainer beam keeps molding in place
- Secure beams by bolting through frames in all situations
- Individual Beams:
 - Top Beam—2" standoff
 - Middle Beam—8" standoff
 - Bottom Beam—14" standoff
- Standard finishes: Sahara or Blue Gray

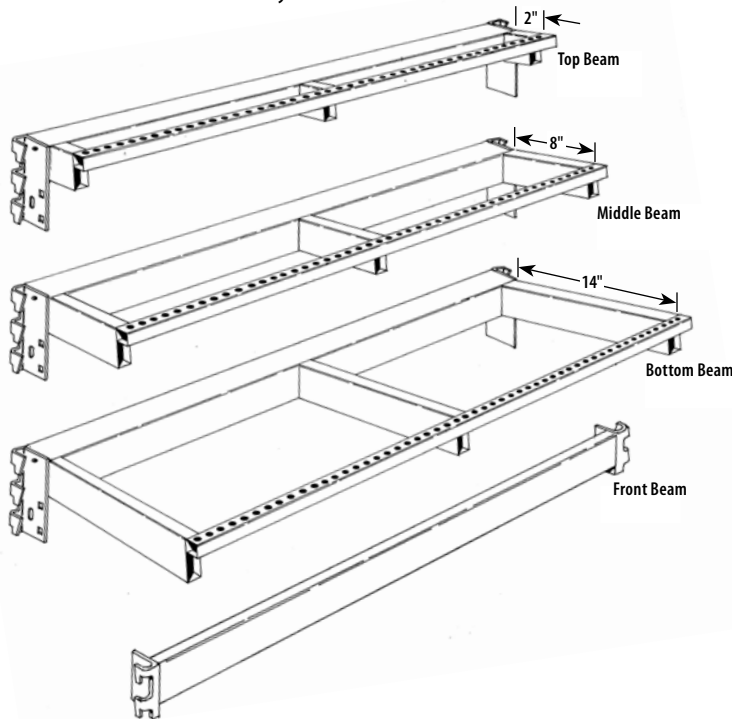

WSMR(TYPE)-(NL)(ND)

- WSMR Wide Span Molding Rack
 TYPE K=Kits
 B=Individual Beams
 NL Nominal Length
 48" to 96" in 12" increments
 (1219 mm to 2438 mm in 304 mm increments)
 ND Nominal Depth
 2" to 14" in 6" increments
 (50 mm to 355 mm in 152 mm increments)

LDWSFB(NL)

- LD Light-Duty
 WSFB Wide Span Front Beam
 NL Nominal Length
 48" to 96" in 12" increments
 (1219 mm to 2438 mm in 304 mm increments)

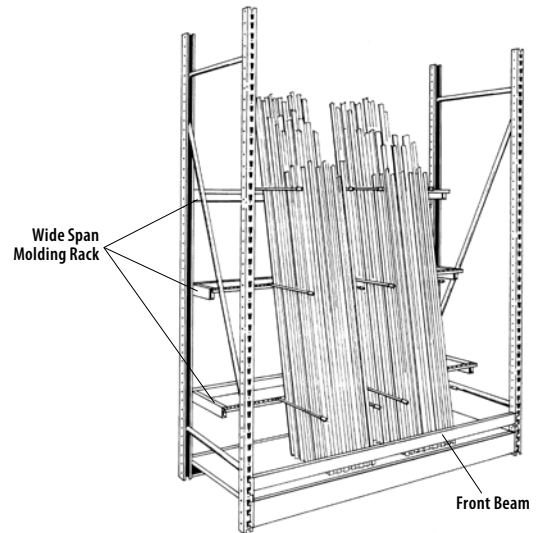

Suspended Wide Span

- Split Wide Span section into a smaller section to spotlight product
- No disassembly of section to install
- Load capacity 200 lbs for entire Hanging Wide Span section
- Standard finishes: Sahara or Blue Gray

Q10871-(NH)(NL)-2

- Q10871 Adjustable Tire Beam
 NH Nominal Beam Height
 35=3½" (89 mm)
 50=5" (127 mm)
 60=6" (152 mm)
 NL Nominal Length 36"-96" in 6" increments
 (914 mm-2438 mm in 152 mm increments)
 2 Step-2

SWSFA

SWSFA Suspended Wide Span Frame Adapter



Hanging Wide Span			
Part Number	Part Description	Qty	Notes
Q10871-(NH)(NW)-2	Adjustable Tire Beam	2	
SWSFA	Suspended Wide Span Frame Adapter	1	
(TYPE)WSF(ND)(NH)	Wide Span Frame	1	Match depth of section
(TYPE)WSDS(ND)	Wide Span Deck Support	as needed	
Wide Span Decking	any deck (wood/wire)	as needed	

Wide Span Vertical Divider Beam

- Use Vertical Divider Beam, Regular- or Heavy-Duty Vertical Divider Arms or other VDB accessories
- Unit includes Modified Wide Span Beam, punched tubing, and required hardware for assembly
- Madix recommends bolting beam to Wide Span Frame in heavy loading situations
- Standoff from beam face approximately 3" (76 mm)
- Standard finishes: Sahara or Blue Gray

WSVDB(NL)

WSVDB Wide Span Vertical Divider Beam
 NL Nominal Length
 36", 48", 60", 84", 96" or 108"
 (914 mm, 1219 mm, 1524 mm,
 2134 mm or 2438 mm)

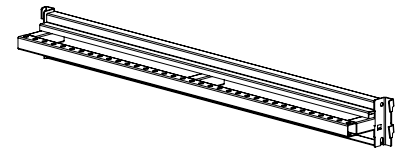

Vertical Divider Arms

- Attaches straight in to the crossbar, or can be affixed at a 45° angle in either direction
- Regular-Duty Divider Arms .40" (10 mm) diameter with red neoprene safety tip
- Heavy-Duty Divider Arms 1" (25 mm) square tubing with vinyl safety cap
- Standard finishes: Sahara or Blue Gray

VDA-(NL)(TYPE)

VDA Vertical Divider Arms
 NL Nominal Divider Length
 10" to 18" in 2" increments, Regular-Duty
 (254 mm to 457 mm in 51 mm increments)
 20" to 30" in 2" increments, Heavy-Duty
 (508 mm-762 mm)
 TYPE R=Regular-Duty
 H=Heavy-Duty

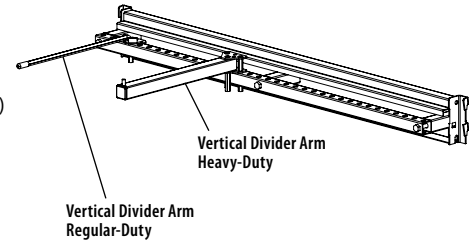

Threaded Vertical Divider Arms

- Mounts straight out from the Vertical Divider Bar, or can be affixed at a 45° angle in either direction
- Arms may be mounted to front and/or rear of standoff bars
- Regular-duty divider arms .40" (10 mm) diameter with red neoprene safety tip
- Heavy-duty arms 1" (25 mm) square tubing with vinyl safety cap
- Threaded option locks arm
- Standard finishes: Sahara or Blue Gray

TVDA-(NL)(TYPE)

TVDA Threaded Vertical Divider Arm
 NL 6" to 20" in 2" increments, Regular-Duty
 (152 mm to 508 mm in 51 mm increments)
 12" to 30" in 2" increments, Heavy-Duty
 (305 mm-762 mm in 51 mm increments)
 TYPE R=Regular-Duty
 H=Heavy-Duty

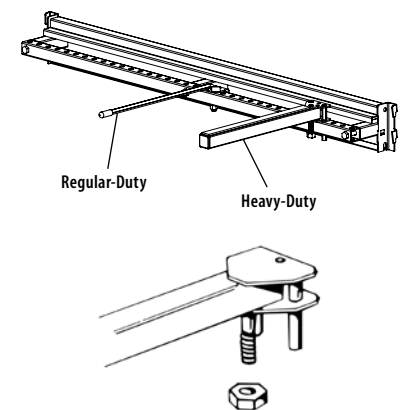

Vertical Divider Arm with Price Tag Holder

- Available in regular-duty only
- Regular-duty divider arms .40" (10 mm) diameter with red neoprene safety tip
- Price Tag Holder 3"W x 1½"H (76 mm x 38 mm)
- Standard finishes: Sahara or Blue Gray

VDA-(NL)R-PTH

VDA Vertical Divider Arms
 NL Nominal Divider Length
 04" to 22" in 2" increments
 (102 mm to 559 mm in 51 mm increments)
 R Regular-Duty
 PTH Price Tag Holder

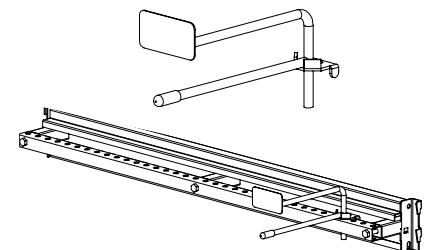

Vertical Divider Arm Heavy-Duty Scan Hook

- Available in heavy-duty only
- Price Tag Holder size 3"W x 1½"H (76 mm x 38 mm)
- Standard finishes: Sahara or Blue Gray

VDAHDSH-(NL)

VDA Vertical Divider Arms
 HD Heavy-Duty
 SH Scan Hook
 NL Nominal Length
 6" to 20" in 2" increments
 (152 mm to 508 mm in 51 mm increments)

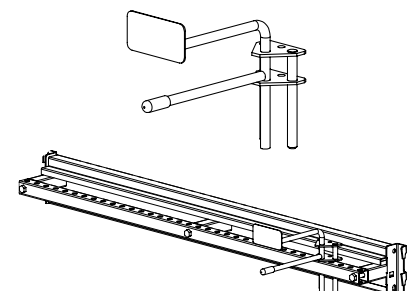

Vertical Divider Arm with 45° Hook

- Available in regular-duty only
- 45° hook securely holds merchandise onto arm
- Standard finishes: Sahara or Blue Gray

VDA-(NL)R-45

VDA Vertical Divider Arms
 NL Nominal Frame Length
 6" to 22" in 2" increments
 (152 mm to 559 mm in 51 mm increments)
 R Regular-Duty
 45 45° Hook

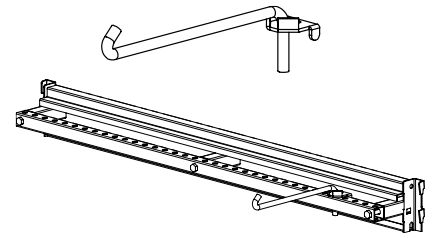

Vertical Divider Arm Heavy-Duty with Front Lip

- Available in heavy-duty only
- Standard finishes: Sahara or Blue Gray

VDA-(ND)H-FL

VDA Vertical Divider Arms
 ND Nominal Depth
 16" to 24" in 2" increments
 (406 mm to 610 mm in 51 mm increments)
 H Heavy-Duty
 FL Front Lip

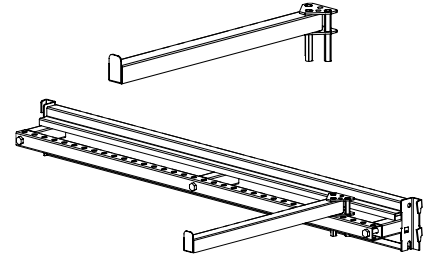

Vertical Divider Arm with 15° Uptilt, Heavy-Duty

- Available in heavy-duty only
- Standard finishes: Sahara or Blue Gray

VDA15DU-(NL)H

VDA Vertical Divider Arm
 15DU 15° Uptilt
 NL Nominal Length
 12" to 24" in 2" increments
 (305 mm to 610 mm in 51 mm increments)
 H Heavy-Duty

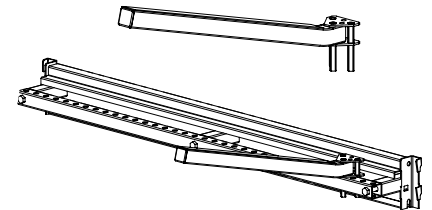

Wide Span Garden Tool Display Bar

- Heavy-duty upright channel welded to Wide Span brackets
- May be used on both Wide Span and Pallet Rack uprights
- Allows use of beam-mounted accessories with locking clips—no hardware required
- Standard finishes: Sahara or Blue Gray

WSGTDB-(NL)

WS Wide Span
 GTDB Garden Tool Display Bar
 NL Nominal Length
 48" or 96" (1219 mm or 2438 mm)

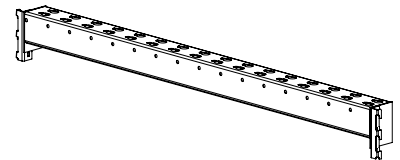

Wide Span Single Hook Display

- Single arm for crossbar
- Fits Garden Tool Display Bar
- Standard finishes: Sahara or Blue Gray

WSSHD-(ND)

WS Wide Span
 SHD Single Hook Display
 ND Nominal Depth
 18", 24", 30" or 36"
 (457 mm, 610 mm, 762 mm or 914 mm)

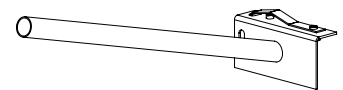

Wide Span Garden Tool Display Double Hook

- Double, round, tube arm
- Fits on Garden Tool Display Bar
- Standard finishes: Sahara or Blue Gray

WSGTDH-(ND)

WS Wide Span
 GTDH Garden Tool Double Hook
 ND Nominal Depth
 18", 24", 30" or 36"
 (457 mm, 610 mm, 762 mm or 914 mm)

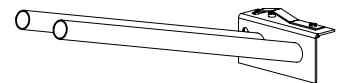

Wide Span, Inside-Mount, Forward-Facing Peg Hook

- Mounts on Wide Span or Hypermaxi regular-duty beams
- Designed for lightweight products
- Mounts by simply twisting onto the back of beam and locking in place

PHWSIMFF10-RD

PHWS Peg Hook Wide Span
 IMFF Inside Mount Front Facing
 10 Nominal Length 10" (254 mm)
 RD Regular-Duty

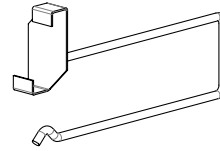

Wide Span, Regular-Duty, Beam-Mounted, Long-Handled Tool Hook

- Mounts on Wide Span or Hypermaxi regular-duty beams
- Designed to display power trimmers in front of boxed stock

WSRDBMLHTH-06

WSRD Wide Span Regular-Duty
 BMLHTH... Beam Mounted, Long-Handled Tool Hook
 06 Nominal Length 06" (152 mm)

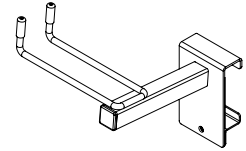

Wide Span Sign Holder, Adjustable Height, Top-Post-Mounted Arm

- Slides into Wide Span Upright; weld nut secures sign frame
- Adjustable height
- Comes with hardware pack
- Standard finishes: Sahara or Blue Gray

WSSHAHTPMA-366022

WSSH.... Wide Span Sign Holder
 AHTPMA.... Adjustable Height Top Post Mounted-Arm
 3660 Height Range
 36" to 60" (914 mm to 1524 mm)
 22....Nominal Length
 22" (559 mm)

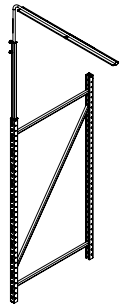

Hypermaxi & Wide Span Sign Holder

- Mounts in Hypermaxi or Wide Span uprights and frames
- Front-facing option faces into aisle
- End-facing option faces over the end cap or at the end of a shelving run
- Includes black cap at the end of wire
- Hook-to-hook length: 12"=6.5" and 18"=10.5" (305 mm=155 mm and 457 mm=267 mm)
- Sign graphics not included

HMSASH(NL)(NH)(OPT1)(OPT2)

HM Hypermaxi
 SASH Single Arm Sign Holder
 NL Height Length 12" or 18"
 (305 mm or 457 mm)
 NH Nominal Height 06" to 42"
 in 6" increments
 (152 mm to 1067 mm
 in 152 mm increment)
 OPT1 Blank=Arched Arm
 SA=Straight Arm
 OPT2 E=End Facing
 F=Front Facing

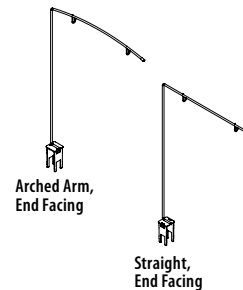

Heavy-Duty Merchandise Hanger

- Easily display and hang heavy products
- Uses Hypermaxi with Pallet Rack beams and deck supports (see below for part numbers; as shown in photo)

A MPRDSWHB-(OPT1)-(OPT2)

MPRD Pallet Regular-Duty
 SWHB Support Wire Hanger Bracket
 OPT1 Wire Size
 301=.301 Gauge
 375=.375 Gauge
 OPT2 3=3" (76 mm)
 4=4" (102 mm)
 5=5" (127 mm)

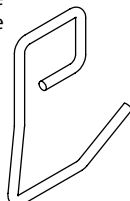

B HMFTB3548-2

HMFTB Hypermaxi Front Tire Beam
 35 Nominal Height 35=3.5" (89 mm)
 48 Nominal Length 48=48" (1219 mm)
 2 Step-2

C HMRTB3548-2

HMRTB Hypermaxi Rear Tire Beam
 35 Nominal Height 35=3.5" (89 mm)
 48 Nominal Length 48=48" (1219 mm)
 2 Step-2

D MPRDS-24

MPRDS Pallet Rack Deck Support
 24 24=24" (610 mm)



Roll-Around Wide Span Unit

- Unit has four swivel casters and comes equipped with locking mechanism to securely hold the unit in place
- 42"W (1067 mm) optional sign holder will hold a 41"W x 15"H x 1/8"D (1041 mm x 381 mm x 8 mm) sign
- 48"W (1219 mm) optional sign holder will hold a 47"W x 5"H x 1/8"D (1193 mm x 381 mm x 8 mm) sign
- Load capacity is 2800 lbs
- Standard finishes: Sahara or Blue Gray

Description	Qty.
A Regular-Duty Wide Span Frame	As Required
B* Regular-Duty Wide Span Deck Support	2
C Regular-Duty Wide Span Beams	As Required
D 5/8" Particle Board Decks	As Required
E 4" Swivel Caster	4
F Locking Mechanism	2

*Regular-Duty Wide Span Deck Support is not visible

RAWSU-24(NW)60(OPT)

RAWSU Roll-Around Wide Span Unit

24 Nominal Depth

24" (610 mm)

NW Nominal Width

42" or 48" (1067 mm or 1219 mm)

60 Nominal Height

60" (1524 mm)

OPT Sign Option:

Blank=Sign Holder

NSH=No Sign Holder

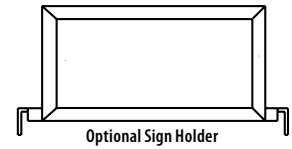

Optional Sign Holder

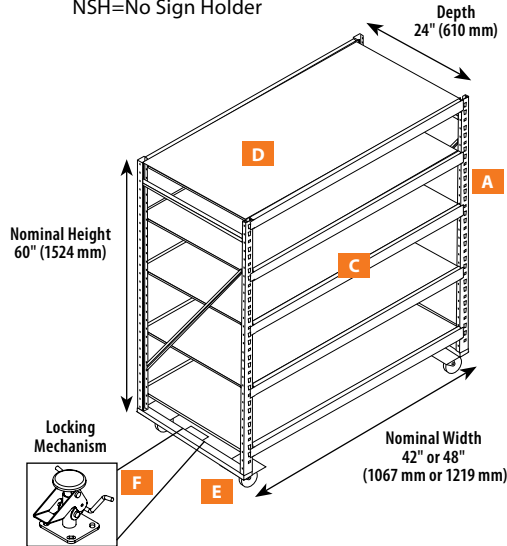

Wide Span Roll Goods Display

- Rigid, super-strong display for roll or spool goods
- Several spools may be used on a single Wide Span Support Arm

A Wide Span Roll Goods Tube Holder

- For mass display of roll goods, tube holder accommodates roll-goods tubes of any diameter
- Holder fits over and bolts to center support arms
- Standard finishes: Sahara or Blue Gray

HMRGTH

HMRGTH... Roll Goods Tube Holder



B Wide Span Roll Goods Tube

- 1" (25 mm) OD galvanized tubing for use with Wide Span Roll Goods Display
- Longer tube lengths not recommended for heavy spools, rolls of chain, or large rolls of flooring
- Load capacity: NL 36" or 48"=200 lbs; NL 60"=150; and NL 72" to 93"=100 lbs

WSRGT-(NW)

WSRGT Wide Span Roll Goods Tube

NW Nominal Width

36" to 96" in 12" increments

(914 mm to 2438 mm in

304 mm increments)

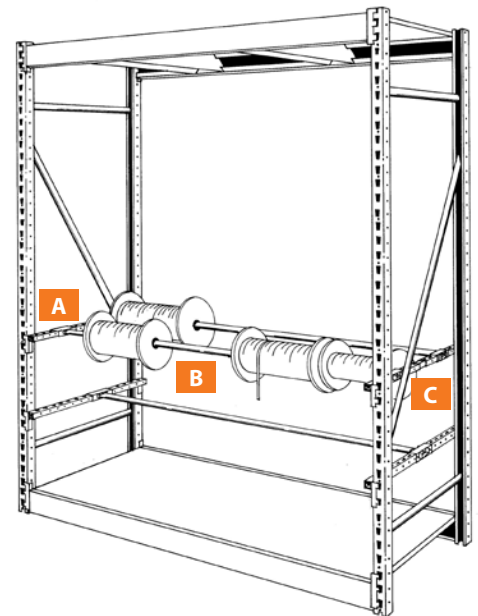

C Wide Span Center Support Arm

- Telescoping feature allows crossbar to slip into upright slots on both sides of frame
- Included dart clips lock crossbar in place
- Provides rigid base for Hypermaxi Roll Goods Tube Holder (HMRGTH)
- Standard finishes: Sahara or Blue Gray

WSCSA-(ND)

WSCSA Wide Span Center Support Arm

ND Nominal Depth

18" to 48" in 6" increments

(457 mm to 1219 mm in 152 mm increments)

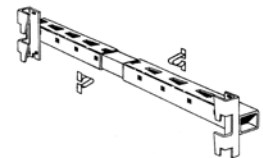

Trailer Coupler & Jack Displays

- Allows consumers to see how the merchandise will look for their application
- When used on Wide Span, stock can be stored above and below display for self-service shopping



Trailer Hitch Support Arm



A-Frame Trailer Coupler Angled

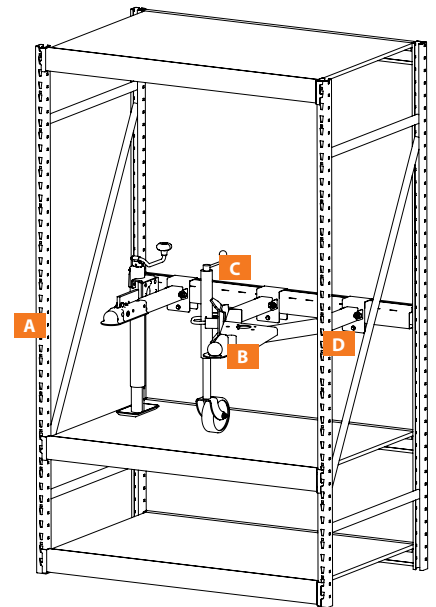

A Trailer Hitch Support Arm

- Use for single trailer tongue
- Jack can be attached as well
- For each arm, order one Trailer Hitch Bracket (THSB)

THSA(NL)

THSA Trailer Hitch Support Arm
 NL Nominal Length 10" to 28" in 2" increments and 40" (254 mm to 711 mm in 51 mm increments and 1016 mm)

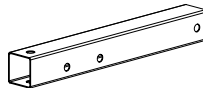

B A-Frame Trailer Coupler Angled

- Use for A-frame trailer tongue
- Two required when used with A-frame
- For each arm, order two Trailer Hitch Brackets (THSB)

AFTCA(NL)

AFTCA A-Frame Trailer Hitch Coupler Angled
 NL Nominal Length
 Blank=16" (406 mm)
 28=28" (711 mm)

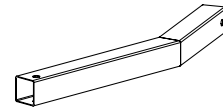

C Trailer Hitch Support Bracket

- Bracket saddles rear beam
- Both arms attach to Trailer Hitch Support Bracket (THSB) with a bolt
- For each arm, order one Trailer Hitch Brackets (THSB)

THSB

THSB Trailer Hitch Support Bracket

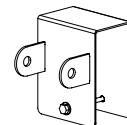

D Adjustable Tire Beam

- Use as rear beam for Trailer Hitch Support Arm [THSA(NL)]
- Trailer Hitch Support Bracket (THSB) saddles Adjustable Tire Beam
- Use 3.5 and 1 step beam for this application

Q10871-(NH)(NL)-2

Q10871 Wide Span Tire Display
 NH Nominal Beam Height
 35=3.5" (89 mm)
 50=5" (127 mm)
 60=6" (152 mm)
 NL Nominal Length 36" to 144" and 150" (914 mm to 3658 mm and 3810 mm)
 2 Step-2



Suspended Maxi in Wide Span

Designed to merchandise pegged or shelved merchandise in a Wide Span section while keeping the decks beneath clear for display of larger items. May be used in any section height greater than 72" (1829 mm) and with all beam lengths. The system is depth adjustable and accepts Maxi Line accessories. Load capacity is 800 pounds.

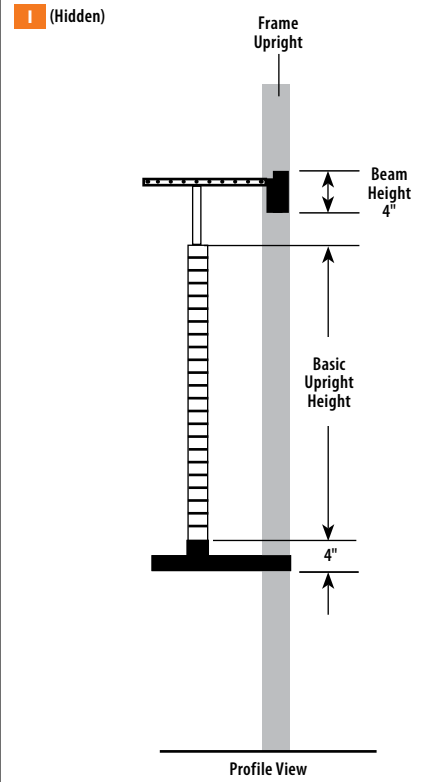
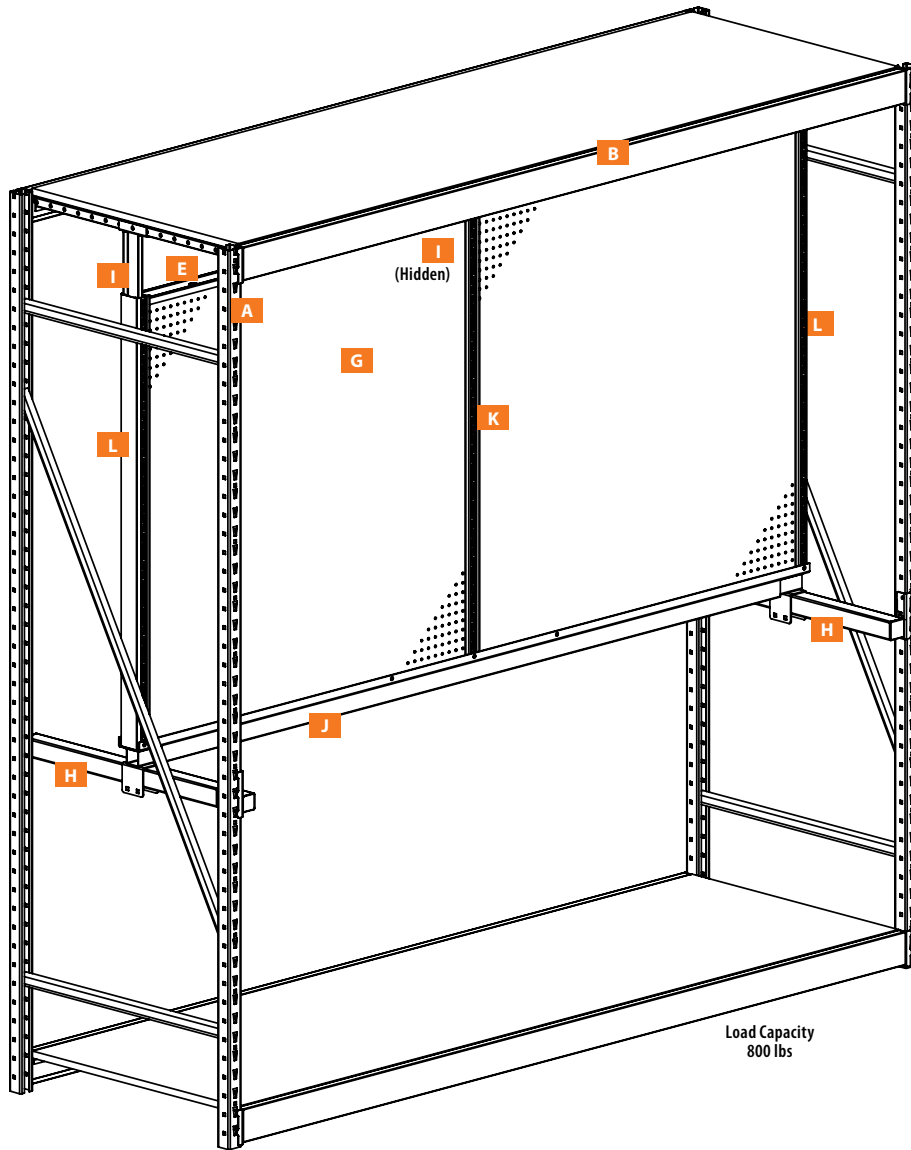

Description	Part Number	Qty.
A Wide Span Frames	(TYPE)WSF(ND)(NH)	As Required
B Wide Span Beams	(TYPE)WSFB(NL)	2
C* Wide Span Deck Supports	(TYPE)WSDS(ND)	As Required
D* Wide Span Decks	Various Decks to choose from	As Required
E Top Spanner	STL-(NW)	4
F* Center Spanner	SC-(NW)	2
G Extension Back Panels, pegboard or hardboard	BX(TYPE)-(NW)(NH)	4
H Basic Upright Support, frame depth	PRBUNDS-(ND)	1 Pair
I* Basic Upright Support Bracket, Modified Omega	WSUSB-(ND)	3
J Basic Upright Support, beam length	PRBUNWS-(NL)	1
K Suspended Maxi Basic Upright	PRBU-(NH)	1
L Suspended Maxi Basic Upright, flush side	PRFSBU-(NH)	2
M* STL Clip	STLCLIP	1 Pair

*Not shown

NOTE!
All parts standard finishes:
Sahara or Blue Gray

Suspended Maxi in Wide Span

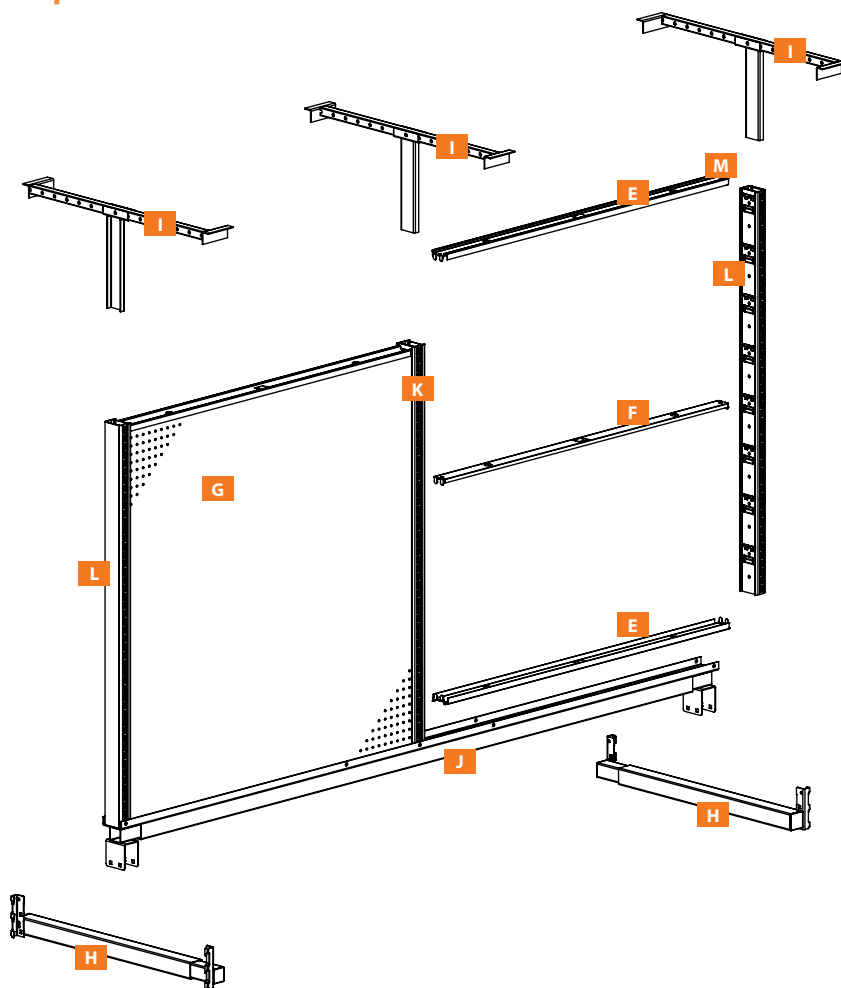

E STL-(NW)

STL....Top Spanner
NW....Nominal Width 3' or 4' (914 mm or 1219 mm)

- STL Clips installed with Top Spanners

F SC-(NW)

SC....Center Spanner
NW....Nominal Width 3' or 4' (914 mm or 1219 mm)

G BX(TYPE)-(NW)(NH)

BX....Extension Back
TYPE....P=Pegboard, H=Hardboard
NW....Nominal Width 3' or 4' (914 mm or 1219 mm)
NH....Nominal Extension Height 6" to 54" in 6" increments
(152 mm to 1372 mm in 15.24 increments)

H PRBUNDS-(ND)

PRBUNDS....Pallet Rack Basic Upright Supports
ND....Nominal Depth 36" or 48" (914 mm or 1219 mm)
• Pairs

I WSUSBO-(ND)

WSUSBO....Wide Span Upright Support Bracket Offset
ND....Nominal Depth 24", 30", 36", 42" or 48"
(610 mm, 762 mm, 914 mm, 1067 mm or 1219 mm)

J PRBUNWS-(NL)

PRBUNWS....Pallet Rack Basic Upright Supports,
Beam Length
NL....Nominal Length 48", 72" or 96"
(1219 mm, 1829 mm or 2438 mm)

K PRBU-(NH)

PRBU....Pallet Rack Basic Upright
NH....Nominal Height 24", 30" or 36"
(610 mm, 762 mm or 914 mm)

L PRFSBU-(NH)

PRFSBU....Pallet Rack Basic Upright, Flush Side
NH....Nominal Height 24", 30" or 36"
(610 mm, 762 mm or 914 mm)

M* STLCLIP

STLCLIP....Top Spanner Clip
• One pair secures Top Spanner (STL-(NW))

*Not shown

NOTE!

Order the required number of backs for designated units; order separately Hardboard BXH-(NW)(NH) or Pegboard BXP-(NW)(NH).

Wide Span Gravity Feed Battery Rack

- Deck is sturdy-gauge wire, approximately $\frac{5}{16}$ " (8 mm) diameter, on 3" (76 mm) grid centers with integrated steel, support channels
- Optional super-slip or corrosion-resistant coating
- Decks install in special-height Wide Span Frames, with rear beam 8" (203 mm) higher than front beam for a 12° slope
- Load capacity is 4000 lbs per section
- Load capacity is 1000 lbs per beam pair
- Standard finishes: Sahara or Blue Gray

NOTE!

Gravity Feed Beams (HMGFB-60RD) used for battery racks must never exceed 60" in length due to load capacity.

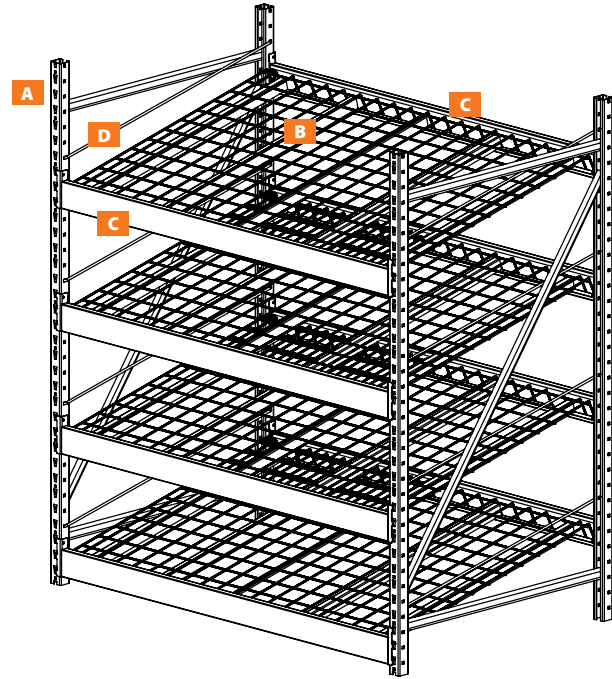

To order as shown in diagram:

A RDWSF3668

RDWSFRegular-Duty Wide Span Frame
36Nominal Depth 36" (914 mm)
68Nominal Height 68" (1727 mm)

B HMGFWD-360860

HMGFWDGravity Feed Wire Deck
36Nominal Depth 36" (914 mm)
08Beam Height Difference 8" (203 mm)
60Nominal Width 60" (1524 mm)

C HMGFB-60RD

HMGFBGravity Feed Beam
60Nominal Width 60" (1524 mm)
RDRegular-Duty

D BRRW-36

BRRWBattery Rack Retainer Wire
36Nominal Depth 36" (914 mm)

E WSREP-20

WSREPWide Span Retainer Pin
20 20 Pack

F WSL-10

WSLSWide Span Leveling Shim
10 10 Pack



NOTE!

Optional Super Slip* Finishes/Codes
PC093 = Black, Super Slip
PC054 = Black, Acid Resistant
PC085 = Silver Vein, Acid Resistant

To order as shown in diagram

Description	Part Number	Qty. per Section	Add-on
A Wide Span Regular-Duty Frame	RDWSF3668	2	1
B Gravity Feed Wire Deck	HMGFWD-360860	4	4
C Gravity Feed Beam	HMGFB-60RD	8	8
D Battery Rack Retainer Wire	BRRW-36	8	8
E Wide Span Retainer Pin, 20 pack	WSREP-20	1	1
F Wide Span Leveling Shim, 10 pack	WSLS-10	1	1

*Color upcharge for Super Slip and acid-resistant paint finishes range from \$2.85 to \$11.40 depending on the part. Contact your Madix Sales Representative for more details.

Wide Span Dog Food Display

- Reversed Wide Span frames have one upright; rotated special beams may be installed from one side
- No diagonal brace allows decks to be continuous
- Frame depths and deck widths sized to accommodate most sizes of bagged pet food or litter
- Standard finishes: Sahara or Blue Gray

RDWSFDF(NH)-(NH)-REV-(OPT)

- RDWSF Regular-Duty Wide Span Frame
 DF Dog Food
 ND Nominal Depth
 20", 24", 28", 36", 48" or 60"
 (508 mm, 610 mm, 711 mm, 914 mm,
 1219 or 1524 mm)
 NH Nominal Height
 24" to 78" in 6" increments
 (610 mm to 1981 mm in
 152 mm increments)
 REV Reversed
 OPT Blank=No Floor Anchor
 FA=Floor Anchor



NOTE!

Do not use Reversed Wide Span Frames for any other purpose due to absence of diagonal brace.

Nominal Depth	Actual Dimension
20"	22 29/32
24"	26 29/32
28"	30 29/32
36"	38 29/32
48"	48 29/32

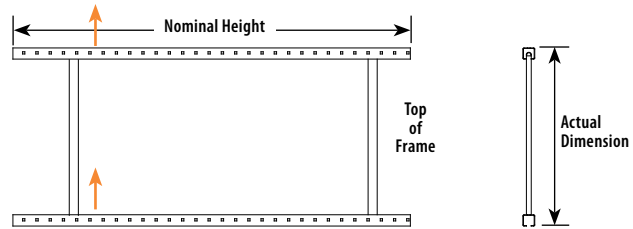

Dog Food Display Front/Rear Beam

- Standard finishes: Sahara or Blue Gray

DFD(TYPE)-(NW)-(OPT)

- DFD Dog Food Display
 TYPE FB=Front Beam
 RB=Rear Beam
 NW Nominal Deck Width
 18", 20", 21", 22" or 27"
 (457 mm, 508 mm, 533 mm or 686 mm)
 OPT MT=Metal Tag Mold
 Blank=No Metal Tag Mold

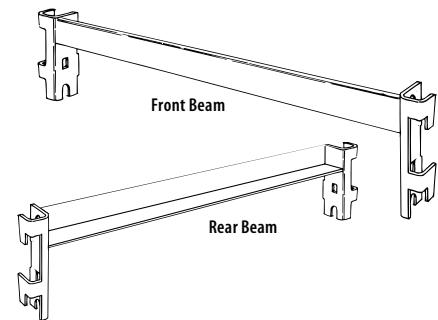

Dog Food Display Deck

Deck Width	Weight Capacity
18"	225
20"	225
21"	350
22"	350
27"	350

DFDD(NW)(ND)-1PB-U

- DFDD Dog Food Display Deck
 NW Nominal Deck Width
 18", 20", 21", 22" or 27"
 (457 mm, 508 mm, 533 mm or 686 mm)
 ND Nominal Frame Depth
 22", 24", 30" or 36"
 (559 mm, 610 mm, 762 mm or 914 mm)
 1PB 1" (25mm) Thick Particle Board
 U Unsealed

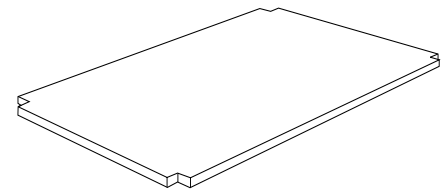

Wide Span Bulk Merchandiser

Top platform allows display of large-profile merchandise requiring a strong support system. Boxed merchandise can be stacked on base below the display. Multiple configurations available.

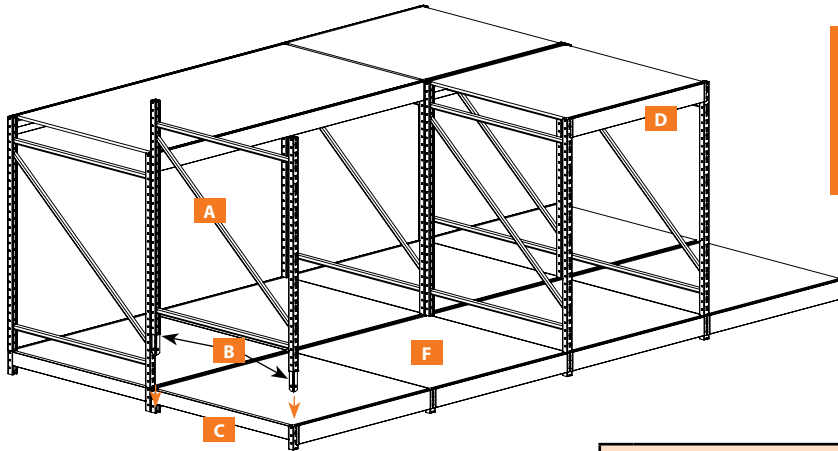

NOTE!

When "HM" beams are ordered with Bulk Merchandiser, uprights are on 48" centerlines and overall length of unit is total of beam lengths plus 1¾".

Bulk Merchandiser			
Description	Part Number	Qty.	
A	Wide Span Frame Extension	WSFE-4860	as required
B	Wide Span Frame Connector	WSFC-2	1 pair per frame
C	Wide Span Single Deck Display Frame	WSSDDF-(ND)(NH)	as required
D	Heavy-Duty Front Beam Upper	HMHDFB48-U	as required
E*	Wide Span Heavy-Duty Deck Supports	HDWSDS48	as required
F	Wide Span Single Display Deck Frame, Sealed	WSSDDFD4848-U	as required

*Not shown here

A Wide Span Frame Extension

- Used for two-level Bulk Merchandiser
- Allows for reconfiguration in store
- One set of Wide Span Frame Connector (WSFC-2) per Wide Span Frame Extension (WSFE-4860)
- Standard finishes: Sahara or Blue Gray

WSFE-4860

WSFE Wide Span Frame Extension
 48 Nominal Width
 48" (1219 mm)
 60 Nominal Height
 60" (1524)

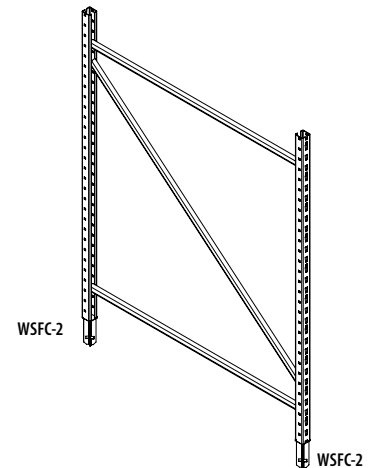

B Wide Span Frame Connector

- Heavy-gauge channel with hardware for connecting any two frames listed to obtain overall heights from 168" to 240" (4267 mm to 6096 mm)
- Packages of two only
- One set per Wide Span Frame Extension (WSFE-4860)
- Standard finishes: Sahara or Blue Gray

WSFC-2

WSFC Wide Span Frame Connector
 2 Pair of 2

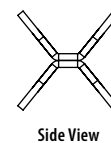

Side View

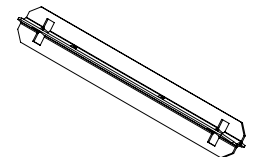

E Wide Span Single Deck Display Frame

- Two required for Bulk Merchandiser Display starter
- One additional for each added section
- Standard finishes: Sahara or Blue Gray

WSSDDF-48(NH)(OPT)

WSSDDF... Wide Span Single Deck Display Frame
 48 Nominal Depth
 48" (1219 mm)
 NH Nominal Height
 04=4" (102 mm)
 06=6" (152 mm)
 OPT Blank=without casters
 C=Casters

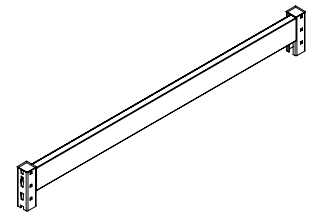

D Heavy-Duty Front Beam Upper **HMHDFB48-U**

- Heavy-gauge beam body with integrated connectors fits snugly into Upright slots and maintains deck alignment with basic fixture slotting
- One beam pair is required per deck
- Standard finishes: Sahara or Blue Gray

HMHD Heavy-Duty
 FB Front Beam
 48 Nominal Width
 48" (1219 mm)
 U Upper

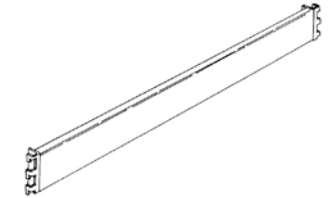

E Heavy-Duty Wide Span Deck Support

- Formed, steel component easily rotates into place, ties beams together, and supports decks
- Standard finishes: Sahara or Blue Gray

HDWSDS48

HDWSDS... Heavy-Duty Wide Span Deck Supports
 48 Nominal Width
 48" (1219 mm)

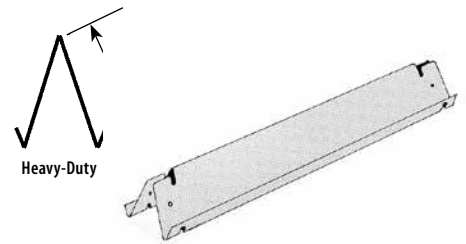

E Wide Span Single Deck Display Frame, Sealed

- Durable 5/8" (16 mm) particle board
- Sealed deck with polymer wax finish

WSSDDFD-4848-U

WS Wide Span
 SDDFD Single Deck Display Frame
 48 Nominal Length
 48" (1219 mm)
 48 Nominal Depth
 48" (1219 mm)
 U Unsealed

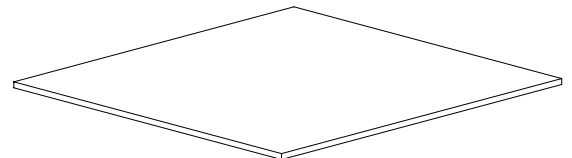

Wide Span Security Doors

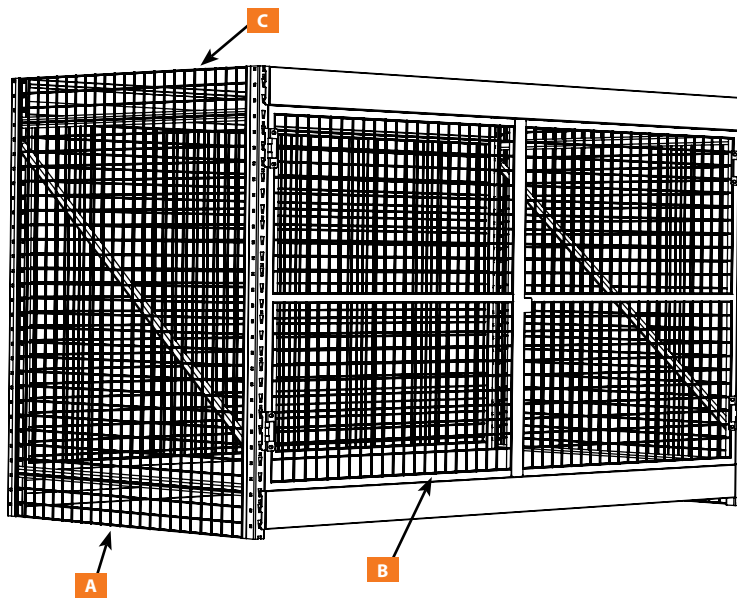

Wide Span Security Doors		
Description	Part Number	Qty.
A Wide Span Wire Grid End Security Panel	WSWGESP-(ND)(NH)	2
B Wide Span Security Doors	WSSD2X2-(NW)(NH)(OPTION)	2
C Wide Span Security Rear Panel	WSSRP(NW)(NH)	2

A Wide Span Wire Grid End Security Panel

- End Security Panels prevent side access to merchandise
- Hardware pack included
- Standard finishes: Sahara or Blue Gray

WSWGESP-(ND)(NH)

WS Wide Span
 WGESP Wire Grid End Security Panel
 ND Nominal Depth
 24", 30", 36" or 42"
 (610 mm, 762 mm, 914 mm or 1067 mm)
 NH Nominal Height
 54", 72", 84" or 96"
 (1372 mm, 1829 mm, 2134 mm or 2438 mm)

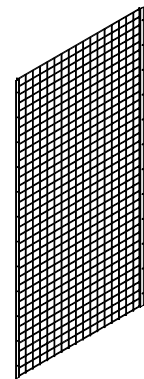

B Wide Span Security Doors

- Secure merchandise by adding Wide Span Security Doors to Wide Span system
- 2" x 2" (51 mm x 51 mm) wire grid
- Locking device is customer supplied
- Hardware pack includes:
 - Pack # 7201-136
 - 4 - 5/16-18 x 1 1/2 HHMS
 - 6 - USS flat washer 5/16" ID, 3/4 OD
 - 4 - 5/16 lock nut
 - 2 - Aviat lock nut 1/4-20
 - 2 - PHSMS 1/4-20 x 3/4
 - Pack # 7201-162
 - 1 - Security hasp w/rotating eye, Zinc coated
 - 2 - Security barrel bolt
 - 17 - FST/PHSMS 310 3/4 AB
 - Pack # 7201-166
 - 4 - 5/16-18 x 1 1/2 HHMS
 - 6 - USS flat washer 5/16" ID, 3/4 OD
 - 4 - 5/16 lock nut
 - 2 - dart clip .020 spring steel
- Standard finishes: Sahara or Blue Gray

WSSD2X2L-(NW)(NH)(NSP)

WS Wide Span
 SD2X2 Security Doors- 2"x2" Grid
 (51 mm x 51 mm)
 L Locking Hasp
 NW Nominal Width
 38", 42", 48", 66", 72", 78", 90", 92" or 96"
 (965 mm, 1067 mm, 1219 mm, 1676 mm, 1828 mm,
 1981 mm, 2286 mm, 2337 mm or 2438mm)
 NH Nominal Height
 48", 72", 78", 84", 96", 108" or 120"
 (1219 mm, 1829 mm, 1981 mm,
 2134 mm, 2438 mm, 2743 mm or 3048 mm)
 NSP NSP=No Security Panels
 Blank=with Security Panels

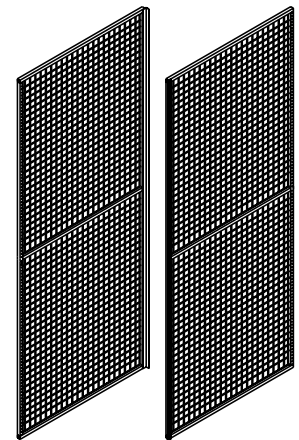

NOTE!

Security Doors include mounting hardware.

Security Doors are mounted between two Regular-Duty beams (additional shelves cannot be installed behind Security Doors).

Use Wide Span Hinge Door Kit (WSHDK) if shelves are needed behind the doors.

Wide Span Security Rear Panel

- Secure merchandise by adding Wide Span Security Doors
- Standard finishes: Sahara or Blue Gray

WSSRP-(NW)(NH)

WS Wide Span
 SRP Security Rear Panel
 NW Nominal Width
 48", 72", 84" or 96"
 (1219 mm, 1828 mm, 2134 mm or 2438 mm)
 NH Nominal Height
 42", 60", 66", 70", 72", 76" or 84"
 (1067 mm, 1524 mm, 1676 mm, 1778 mm,
 1829 mm, 1930 mm or 2134 mm)

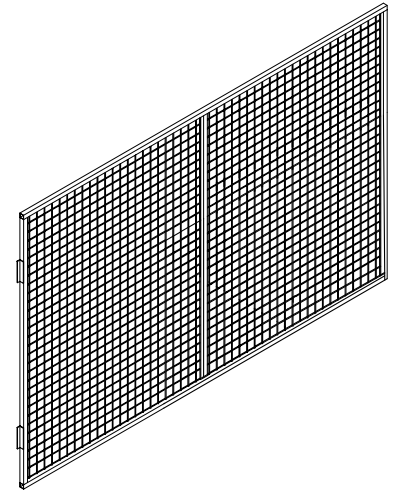

Wide Span Hinged Door Kit

- Optional panel type:
 - 3" x 3" wire grid (76 mm x 76 mm)
 - 1" x 6" wire grid (25 mm x 152 mm)
 - Hardboard
- Available in single or double doors
- Right-hand or left-hand orientation must be indicated when ordering door as a single
- Locking device; customer supplied
- Allows beams to be mounted behind the doors
- Please contact your Madix Sales Representative for other available sizes
- Standard finishes: Sahara or Blue Gray

WSHDK-(NW)(NH)-(OPT1)-(OPT2)-(HAND)

WS Wide Span
 HDK Hinged Door Kit
 NW Nominal Width
 48" or 96" (914 mm or 2438 mm)
 NH Nominal Height
 84" or 96" (2134 mm or 2438 mm)
 OPT1 Panel Type
 3X2=3" x 3" Wire Grid
 (76 mm x 76 mm)
 1X6=1" x 6" Wire Grid
 (25mm x 152 mm)
 HB=Hardboard
 OPT2 Door Type
 S=Single Door
 D=Double Door
 HAND RH=Right-Hand
 LH=Left-Hand

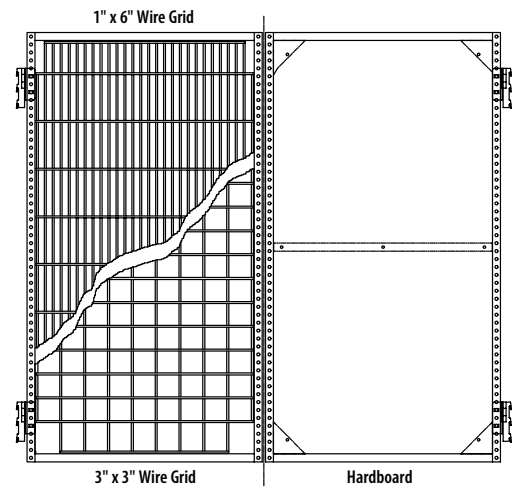

NOTE!
 Hinged Door Kit includes
 mounting hardware.

Wide Span Rear Wire Grid Security Panels

- Secures merchandise when used with Wide Span Hinged Door Kit (WSHDK)
- Allows the installation of intermediate beams

WSRWGSP(NW)(NH)

WS Wide Span
 RWGSP Rear Wire Grid Security Panels
 NW Nominal Width
 36" to 96" in 12" increments
 (914 mm or 2438 mm in 305 mm increments)
 NH Nominal Height
 72" to 96" in 12" increments
 (1829 mm to 2438 mm in 305 mm increments)

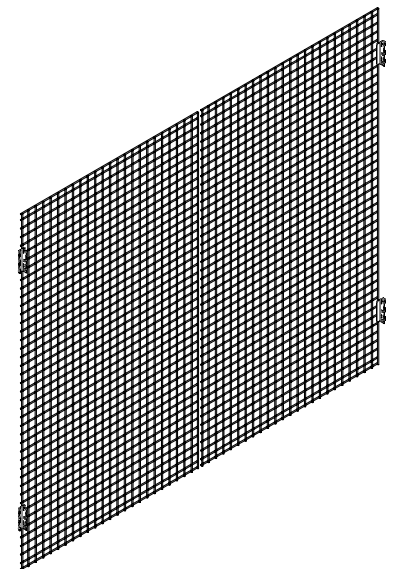

Adjustable Tire Display

- Heavy-gauge, 1 $\frac{3}{4}$ " (44 mm), square, uprights with welded cross braces are slotted 2" (51 mm) OC for adjustability
- Top beam fits flush to top of frame
- Requires minimum of two levels, four beams per section
- Heavy-gauge beam body with integrated connectors fits snugly into upright slots and maintains deck alignment with base fixture slotting
- One beam pair is required per level
- Image shows two (B) Adjustable Tire Beams and six (C) deck supports per level Regular-Duty Wide Span Frame, Adjustable Tire Beam, and Deck Support are used to complete this Tire Display
- Beams have slots every 3" (76 mm) to adjust for different tire sizes
- Standard finishes: Sahara or Blue Gray

Q10871-35(NL)-2

- Q10871 Adjustable Tire Display
 35 Nominal Beam Height 3 $\frac{1}{2}$ " (89 mm)
 NL Nominal Length 48", 72", 84" or 96"
 (1219 mm, 1829 mm, 2134 mm or 2438 mm)
 2 Step-2

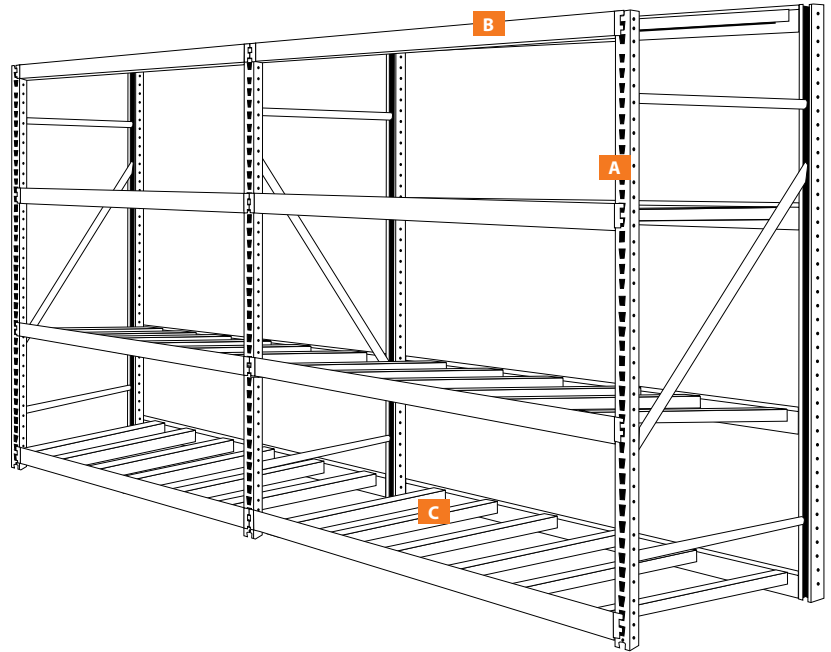

NOTE!

Order depth for Deck Supports is +2"
 Example: Nominal depth of unit is 36",
 order MPRDS-38-HDG.

Description	Part Number	Qty.
A Regular-Duty Wide Span Frame	RDWSF(ND)(NH)	As Required
B Adjustable Tire Beam	Q10871-(NH)(NW)-2	As Required
C Pallet Rack Deck Supports	MPRDS-(ND)-HDG	As Required



Wide Span Gravity Feed System

- Consists of Wide Span Frames, Gravity Feed Channels (below), Gravity Feed Beams, plus other components
- May be stocked from back or front of unit
- Two lower levels show Gravity Feed Channels installed with open face up, on 2½" (64 mm) beams— this position keeps merchandise aligned and is used for canned foods, bottled beverages, petroleum products, and items with similar packaging (transparent front retainers also available)
- Two upper levels show Gravity Feed Channels installed with open face down, on 3½" (89 mm) beams, creating a smooth, slanted surface suitable for boxed or poly-wrapped merchandise
- Finished with Super Slip Paint— merchandise slides without assistance, eliminating costly roller systems or plastic trays which may require replacement or maintenance
- Standard finishes: Sahara or Blue Gray

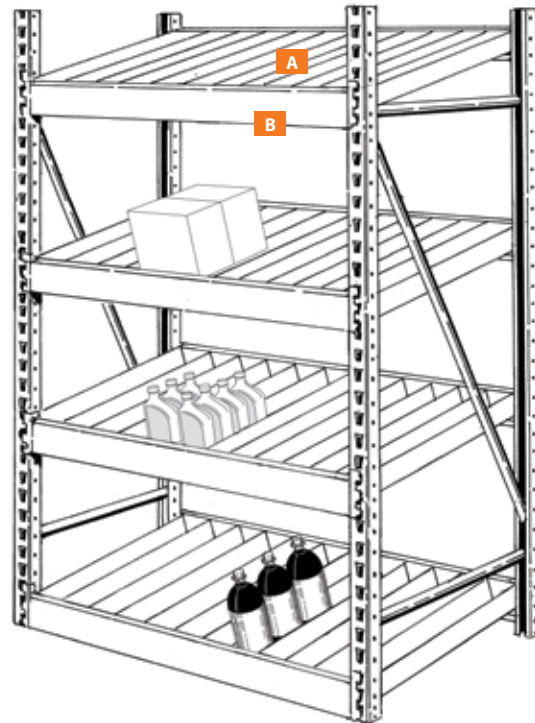
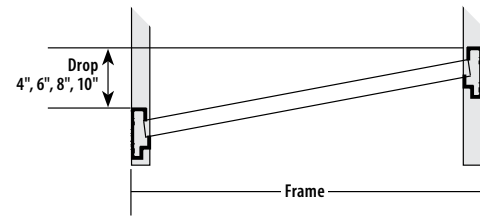

Description	Part Number	Qty.
A Wide Span Gravity Feed Channel	WS(ND)GFC(DROP)(NW)02	As Required
B Gravity Feed Beam	HMGFB(NW)(TYPE)	As Required

A Wide Span Gravity Feed Channel

- Formed from heavy-gauge steel for rigidity and finished in Super Slip Paint, eliminating need for expensive roller systems
- Use 2½" (64 mm) high beam for merchandising bottles and cans, or inverted in the 3½" (89 mm) high beam to merchandise case goods
- For use on any beam style, light-duty, regular-duty or heavy-duty
- Weight capacity is 60 lbs per channel
- Standard finishes: Sahara or Blue Gray

WS(ND)GFC(DROP)-(NW)02

WS Wide Span
 ND Nominal Depth
 See Chart
 GFC Gravity Feed Channel
 DROP See Chart
 NW Nominal Width
 46=4¼", 55=5½", 65=6½",
 72=7¼" or 76=7⅝"
 02 2" (51 mm) Height Only

Finish Code— Super Slip Finishes

PC093 Black
 PC117 Snow White

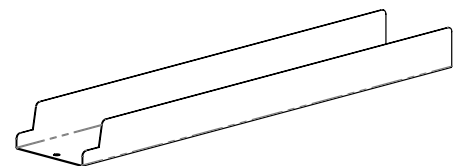

ND/Drop	Actual Length
18/04	19.438"
22/04	23.250"
24/04	25.250"
30/04	30.500"
30/06	31.563"
32/06	33.563"
34/06	36.938"
36/06	37.438"
40/06	42.875"
42/08	43.750"
46/08	49.125"
48/08	49.625"
60/10	61.438"

B Wide Span Gravity Feed Beam

- Standard beam body is inverted on brackets to allow the insertion of the Gravity Feed Channels
- One beam pair required per merchandising level with two Wide Span Retainer Pins (WSREP) to secure each beam
- Standard finishes: Sahara or Blue Gray

HMGFB-48(TYPE)

HMGFB Wide Span Gravity Feed Beam
 48 48" (1219 mm) Length Only
 TYPE LD=Light-Duty (2½" High)
 HD=Heavy-Duty (3½" High)

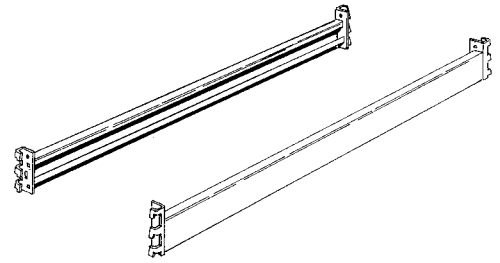
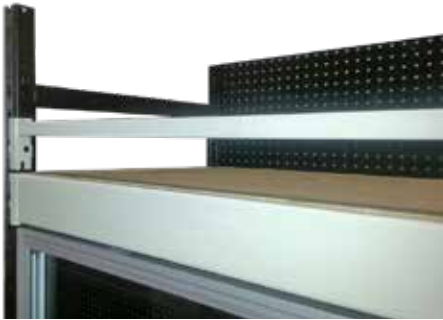
**Hypermaxi Regular-Duty Sliding Door Kit Beam****HMRDSDKB(NW)-(OPT)**

HMRD Hypermaxi Regular-Duty
 SDKB Sliding Door Kit Beam
 NW 36", 48", 72" or 96"
 (914 mm, 1219 mm, 1829 mm or 2438 mm)
 OPT Blank=No Tag Option
 PT=Painted Tag Option

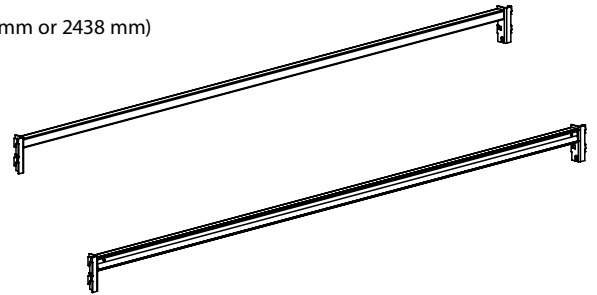
**LEDge Light Beam Canopy Cover**

- Canopy installs over existing beams
- End cover is sloped for more aesthetic appeal
- Helps direct BEAM light down towards product

LLBCCPY(CONF)(NW)-(OPT)

LLBCCPY LEDge Light Beam Canopy Cover
 CONF Configuration=Size and Type
Hypermaxi:
 LDHM=Light-Duty Hypermaxi
 RDHM=Regular-Duty Hypermaxi
 HDHM=Heavy-Duty Hypermaxi
Wide Span:
 LDWS=Light-Duty Wide Span
 RDWS=Regular-Duty Wide Span
 HDWS=Heavy-Duty Wide Span
 NW 36", 48", 60", 72", 84" or 96"
 (914 mm, 1219 mm, 1524 mm,
 1829 mm, 2134 mm or 2438 mm)
 OPT S=Starter Kit
 A=Add-on Kit

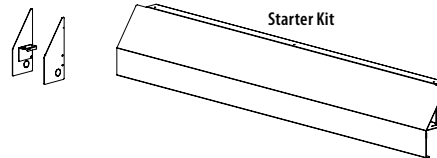
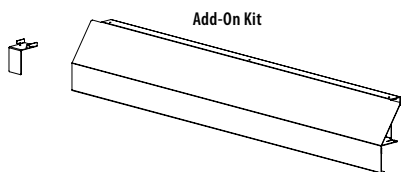

Wide Span Hypermaxi Sign Holder Modified Shelf Mount

- Signage height: NH -2.313"
- Signage width: NW -½" (1 mm); 1.34" (3 mm) overlap
- Signage thickness: ¼" maximum
- May also be installed on Maxi Line Gondola

WSHMSHF(NW)(NH)

WSHM Wide Span Hypermaxi

SHFM Sign Holder Modified Shelf Mount

NW Nominal Width 36", 48", 72", 84", 96" or 108"
(914 mm, 1219 mm, 1829 mm, 2134 mm, 2438 mm or 2743 mm)

NH Nominal Height 12", 24", 36" or 48"
(305 mm, 610 mm, 914 mm or 1219 mm)

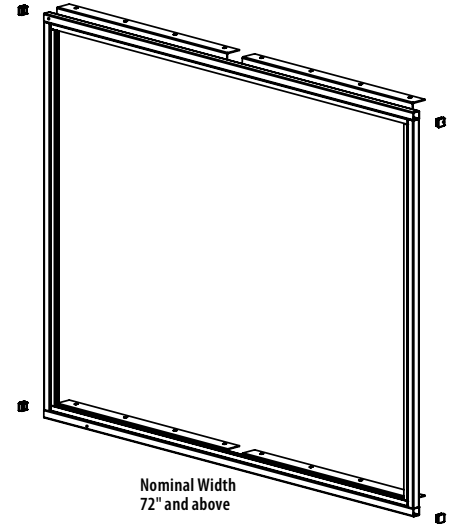
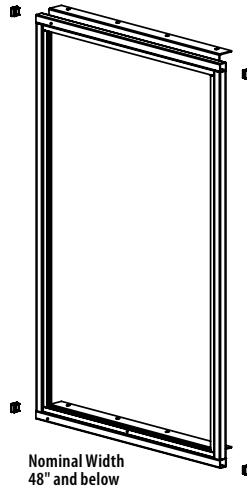

Wide Span Sign Holder Frame

- Unit mounts onto Maxi Line Gondola
- Protudes 2" (51 mm) past nominal depth of shelf, for flush front mounting with cover shelf, order top shelf 2" (51 mm) shorter
- Provides platform for graphics and hides overhead stock
- Nominal Signage Height 21.75" (552 mm)
- Customer provides signage
- May also be installed on Maxi Line Gondola

WS(OPT1)SHF(NW)(NH)(OPT2)

WS Wide Span

OPT1 Blank=Wide Span Length

HM=Hypermaxi Length

SHF Sign Holder Frame

NW Nominal Width 48", 60", 96", 98", 120" or 144"
(1219 mm, 1524 mm, 2438 mm, 2489 mm, 3048 mm or 3658 mm)

NH Nominal Height 36" or 48" (914 mm or 1219 mm)

OPT2 Mounting Options

Blank=Beam Mount

USM=Upper Shelf Mount

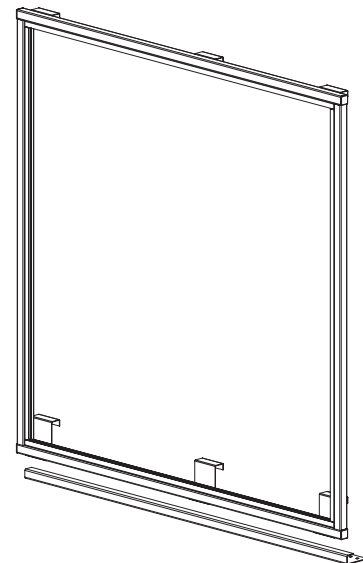

MAXI RACK

Maxi Rack combines the high load capacity of a traditional racking system with a sleek, flush-front look that is perfect for displaying product on a sales floor. Frames feature a 1" (25 mm) OC slot pattern for maximum adjustability, and a hardware-free assembly ensures rapid installation.

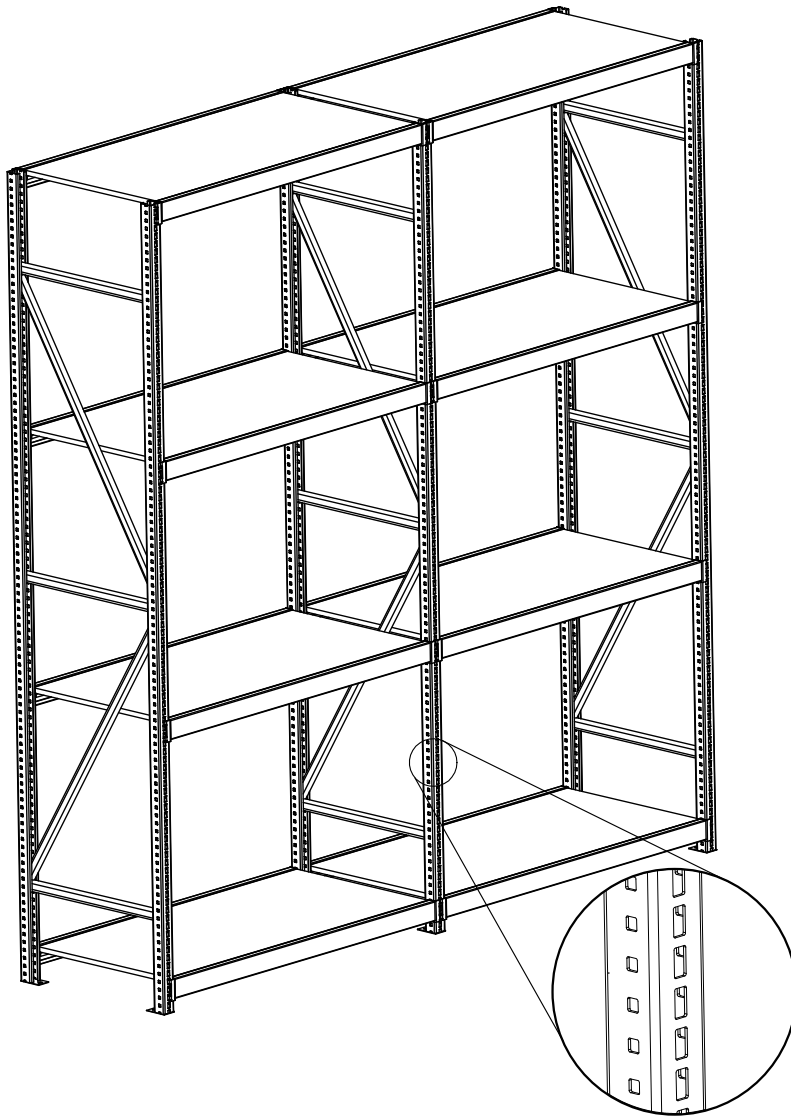

Beam Loading

Maximum Load Capacity per Beam Pair

Beam Length	Light-Duty	Regular-Duty	Number of Supports for Wood Decks	Number of Supports for Wire Decks
48"	1000 #	1600 #	2	2
60"	1000 #	1600 #	3	4
72"	1000 #	1600 #	3	4
84"	1000 #	1600 #	3	4
96"	1000 #	1600 #	3	4

Based on evenly distributed loads and 96" beam length, all frame widths

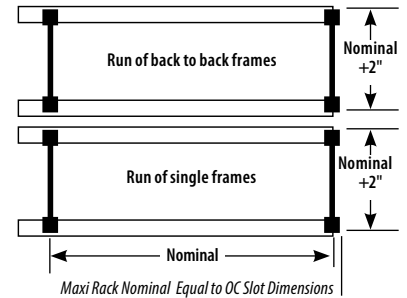

NOTE!
Cannot be used with standard Maxi Line display shelves or accessories



Maxi Rack Frames

- Heavy-gauge, 1 3/4" (44 mm), square, upright members with welded cross braces are slotted
- 1" (25 mm) OC for adjustability
- Heavy-Duty Frame has additional bracing to resist accidental stacker impact
- Top beam fits flush to top of frame
- Requires a minimum of two decks and four beams per section

MRF(ND)(NH)-(OPT)

- MRF Maxi Rack Frame
- ND Nominal Frame Depth
18" to 48" in 6" increments
(457 mm to 1219 mm in 152 mm increments)
- NH Nominal Frame Height
48" to 120" in 12" increments
(1219 mm to 3048 mm in 305 mm increments)
- OPT Blank=as shown
FA=Floor Anchor

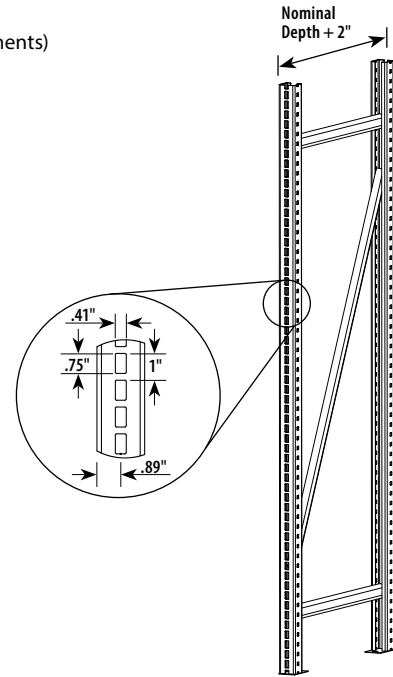
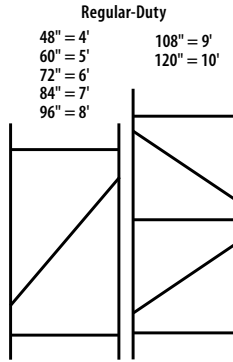
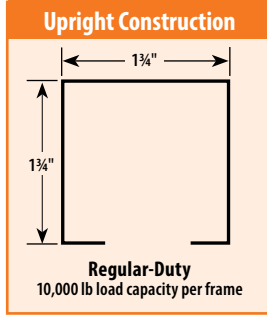

NOTE!
To preclude overturning, the frame depth x 6 cannot exceed height of topmost loaded beam pair, unless all the frames are properly anchored or braced externally.

Maxi Rack Beam

- Heavy gauge beam body with integral connectors fits snugly into 1" OC (25 mm) slots and maintains deck alignment with basic fixture slotting
- One beam pair required per deck
- Maxi Rack Decks ordered separately

MRFB(OPT1)-(NL)

- MRFB Maxi Rack Beam
- OPT1 LD=Light-Duty
RD=Regular-Duty
- NL Nominal Length
24" to 96" in 6" increments
(610 mm to 2438 mm in 152 mm increments)

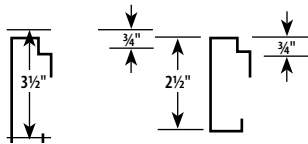

Regular-Duty Maximum Capacity 1600 lbs per pair*

Light-Duty Maximum Capacity 1000 lbs per pair*

*Based on evenly distributed loads, 96" beam lengths, all frame lengths

Configurable Options FIN1-TAG-FIN2

- FIN1 Beam Finish
- TAG Tag Mold Option
Blank=No Tag
DGA2P=Powder Coat Finish - Different from Shelf
DGA2A=Silver Finish
- FIN2 Optional Tag Finish

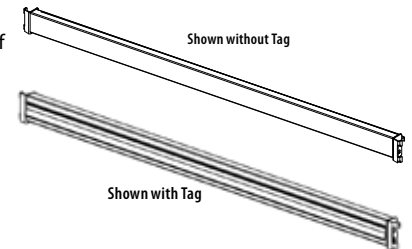

Maxi Rack Top Cap

- Clear plastic cap inserts into top of upright
- Allows beam to be mounted in top slot of upright

WSTC-1-CL

- WSTC Maxi Rack Top Cap
- PACK 1=1 Pack
- CL Clear Plastic

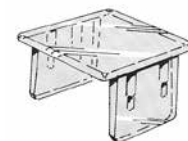

Maxi Rack Dart Clip

- Spring steel clip secures beam to frame, preventing accidental disengagement
- Two required per beam

WSDC25-50

WSDC Maxi Rack Dart Clip
 25 Thickness .250" (6 mm)
 50 50= 50 Pack

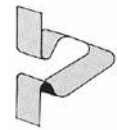

Maxi Rack Deck Support

- Formed steel component easily rotates into place, ties beams together, and supports deck

(TYPE)WSDS(ND)

TYPE LD=Light-Duty
 RD=Regular-Duty
 WSDS Maxi Rack Deck Support
 ND Nominal Depth 18" to 48" in 6" increments
 (457 mm to 1219 mm in 152 mm increments)

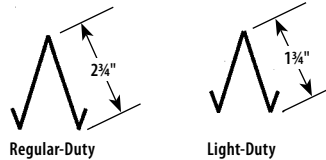
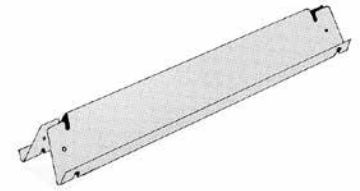

Deck Supports per Beam Length	
Beam Length	Supports
48"	2
60" to 72"	3
84" to 96"	4

Maxi Rack Deck

- Regular-Duty Decks are durable 5/8" (16 mm) particle board

WSHMDRD(ND)(NL)-U

WSHM Maxi Rack Deck
 RD Regular-Duty
 ND Nominal Depth
 18" to 48" in 6" increments
 (457 mm to 1219 mm in 152 mm increments)
 NL Nominal Length
 24" to 96" in 6" increments
 (610 mm to 2438 mm in 152 mm increments)
 U Unsealed

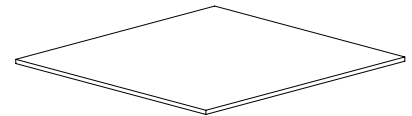

Maxi Rack Wire Deck

- Wire Grid Decks are pieced for ease of handling
- Sturdy wire, 5/16" (8 mm) gauge in diameter, is welded on 1" x 6" (25 mm x 152 mm) grid centers
- Deck Supports are NOT included; order per chart

WSHMWD-(NL)(ND)1/2X6

WSHM Maxi Rack
 WD Wire Deck
 NL Nominal Length
 48" or 96" (1219 mm or 2438 mm)
 ND Nominal Frame Depth
 16", 20", 22" or 24"
 (406 mm, 508 mm, 559 mm or 610 mm)
 1/2X65"x 6" Grid (13x 152 mm)



Deck Supports per Beam Length	
Beam Length	Supports
48" to 54"	2
84" to 96"	4

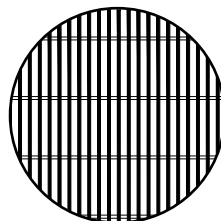

Sample Metal Grid Pattern

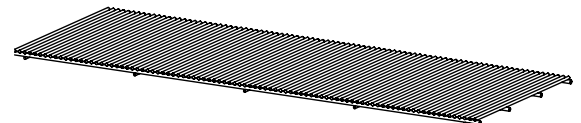

Maxi Rack Gravity Feed System

- Deck is sturdy-gauge wire, approximately 5/16" (8 mm) diameter, on 3" (76 mm) grid centers with integrated steel, support channels
- Optional super-slip or corrosion-resistant coating
- Decks install in special Maxi Rack Gravity feed beams with rear beam higher than front beam to create a slope, feeding the product forward

To order as shown in diagram

Description	Part Number	Qty. per Section	Add-on
A Maxi Rack Frames with Floor Anchor	MRF2060FA	2	1
B Maxi Rack Gravity Feed Wire Deck Light-Duty	HMGFWDLD200248	4	4
C Maxi Rack Gravity Feed Beam, Light-Duty	MRGFB48-LD	8	8
D Maxi Rack Gravity Feed Retainer Wire	BRRW-20	8	8

*Color upcharge for Super Slip and acid-resistant paint finishes range from \$2.85 to \$11.40 depending on the part. Contact your Madix Sales Representative for more details.

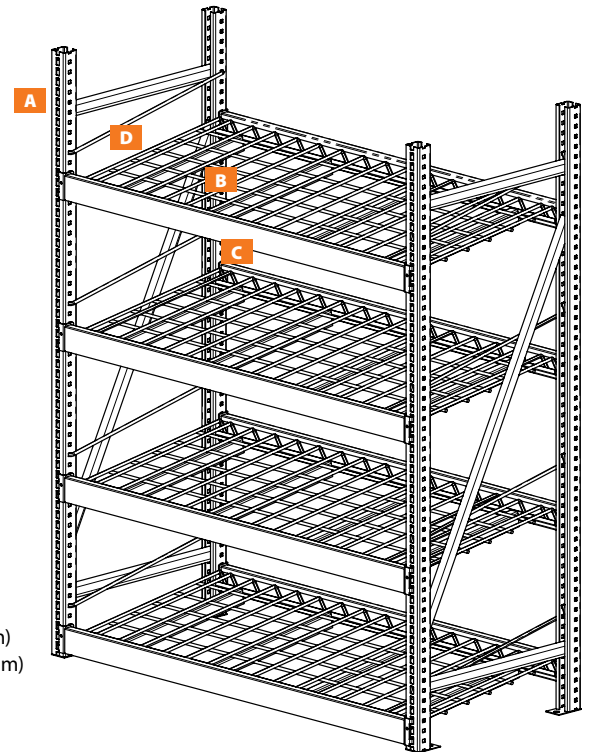

A Maxi Rack Frame

- Heavy-gauge, 1 3/4" (44 mm), square, upright members with welded cross braces are slotted
- 1" (25 mm) OC for adjustability
- Heavy-Duty Frame has additional bracing to resist accidental stacker impact
- Top beam fits flush to top of frame
- Requires a minimum of two decks and four beams per section

MRF2060FA

- MRFMaxi Rack Frame
- 20Nominal Depth 20" (508 mm)
- 60Nominal Height 60" (1524 mm)
- FAFloor Anchor

B Maxi Rack Gravity Feed Wire Deck

- Gravity feed wire deck is designed to engage with front and back beams at an angle, feeding product forward
- Built in deck supports

HMGFWDLD-200248

- HMGFWDMaxi Rack Gravity Feed Wire Deck
- LDLight-Duty
- 20Nominal Depth 20" (559 mm)
- 02Beam Height Difference 2" (25 mm)
- 48Nominal Width 48" (1219 mm)

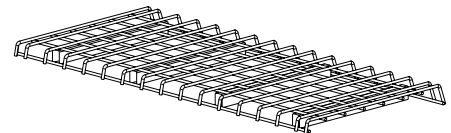

C Maxi Rack Gravity Feed Beam, Light-Duty

- Gravity Feed Beams engage into front and rear slots on Maxi Rack Frames

MRGFB48-LD

- MRGFBMaxi Rack Gravity Feed Beam
- 48Nominal Width 48" (1219 mm)
- LDLight-Duty

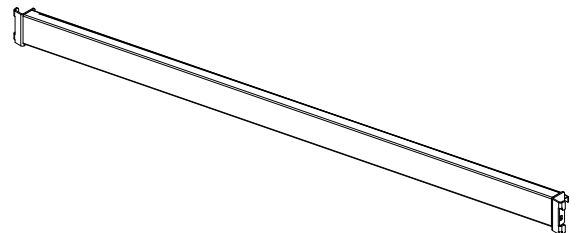

D Maxi Rack Gravity Feed Retainer Wire

BRRW-20

- BRRWMaxi Rack Gravity Feed Retainer Wire
- 20Nominal Depth 20" (508 mm)

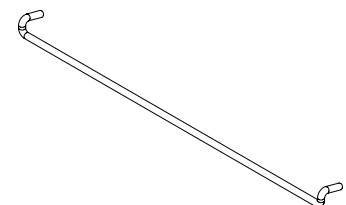

Optional Accessories

Maxi Rack Side Product Retainer

- Installs into the square inside slotting of Maxi Rack Frames [MRF(ND)(NH)-(OPT)], allowing unobtrusive retention of product
- Can be used with both wire or standard decks
- Tool free install

WSSPR(ND)

WSSPRMaxi Rack Product Retainer
 NDNominal Depth 18", 20", 22", 24" or 30"
 (457 mm, 508 mm, 584 mm, 610 mm or 762 mm)

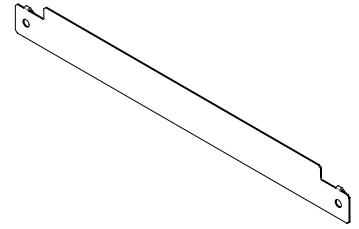

Maxi Rack Header

- Installs into the square inside slotting of Maxi Rack Frames [MRF(ND)(NH)-(OPT)], allowing unobtrusive retention of product
- Can be used with both wire or standard decks
- Tool free install

BRIH(NW)

BRIH Maxi Rack Header
 NW Nominal Width 36", 40", 48", 52", 60", 71", 79" or 92"
 (914 mm, 1016 mm, 1219 mm, 1321 mm, 1524 mm,
 1803 mm, 2007 mm or 2337 mm)

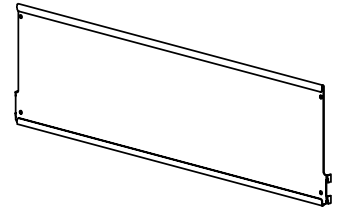

Maxi Rack Back-to-Back Connector

- Heavy-gauge-steel straps maintain 2" (51 mm) spacing between frames to allow repositioning of rear beams
- Hardware included for securing straps to frames
- Six connectors required for any height or combination of height frames
- Floor Anchor might interfere with pallets and pallet jacks if no lower beam is used
- Galvanized finish only

WSBBC-2-24

WSBBC-2 Maxi Rack Back-to-Back Connectors
 24 24 Pack

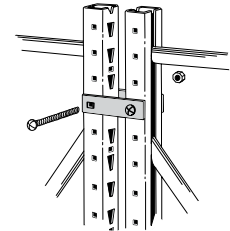

Maxi Rack Rear Product Retainer

- Retains product at rear of shelf to prevent items from falling backward
- Tool free install

HMWMSRPR48

HMWM Maxi Rack
 SRPR Shelf Rear Product Retainer
 48 Nominal Depth 48" (1219 mm)

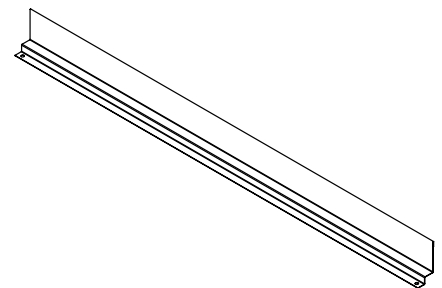

Maxispán

Maxispán shelving is the most effective use of floor space for above-display storage. It completely spans continuous gondola runs when Hypermaxi's height precludes its use, and yet it still gives you the load capacity of our Pallet Rack system. High load capacity and space saving efficiency in a single highly customizable solution.

- Maxispán must be anchored to floor
- Each frame requires 4 anchors
- Maxispán column load capacity is 11,000 lbs. Use this figure in the column loading chart to determine the beam loading per section, or consult your Madix representative for specific capacities for your application
- Spacing over 98" (1219 mm) vertically reduces column load capacity due to lack of support to channel
- When lowest beam is 48" (1219 mm) or higher from floor, always secure frame to floor

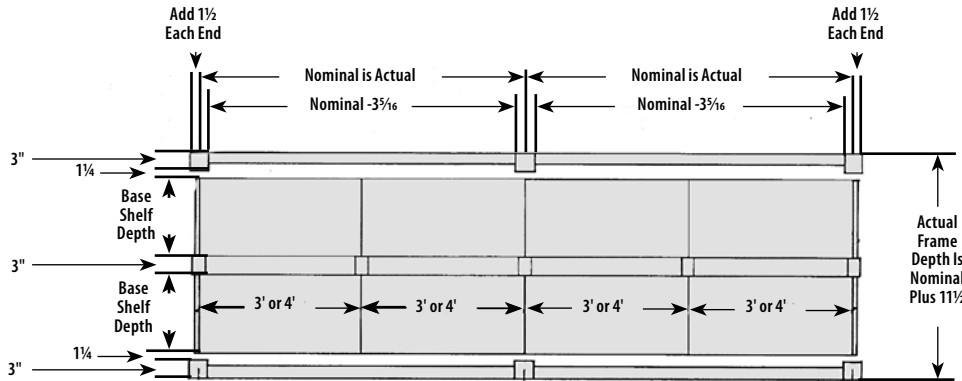
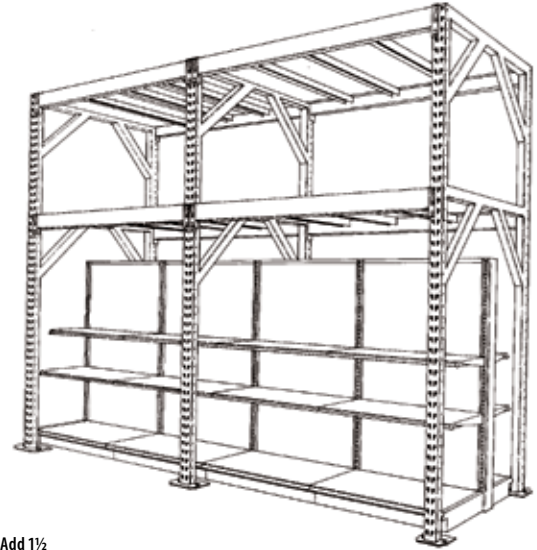

NOTE!
Column load capacity is 11,000 lbs when the bottom of the first beam in no more than 98" (2489 mm) from the floor.

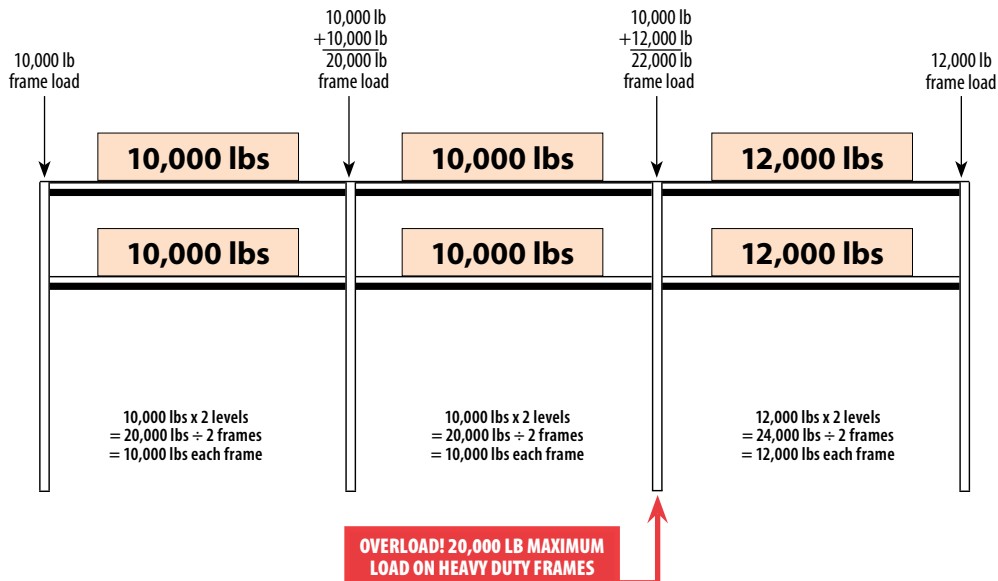

Maxispan Upright

- Maxispan Uprights heights 84" to 144" (2134 mm to 3658 mm) fit over Gondolas Base Shelves 18" to 30" (457 mm to 762 mm) in depth
- Maxispan column load capacity is 20,000 lbs
- Standard finishes: Sahara or Blue Gray

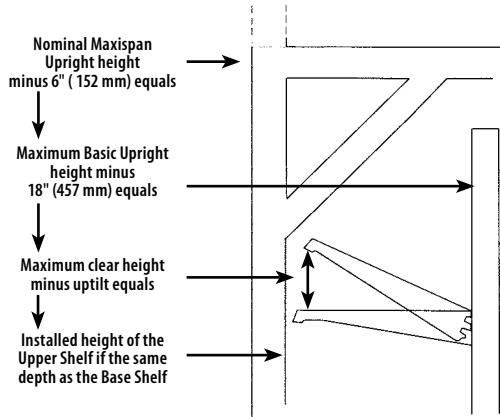

MS2U(NH)-(ND)

- MS2 Maxispan 2" OC (51 mm)
- U Upright
- NH Nominal Frame Height 84" to 144" in 6" increments (2134 mm to 3658 mm in 152 mm increments)
- ND Nominal Frame Depth 36", 40", 44", 48", or 60" (914 mm, 1016 mm, 1118 mm, 1219 mm, or 1524 mm)

Nominal Frame Length	For Gondola Base Shelves	Actual Frame Depth
36"	18" x 18"	47½" (1207 mm)
40"	20" x 20"	51½" (1308 mm)
44"	22" x 22"	55½" (1410 mm)
48"	24" x 24"	59½" (1511 mm)
60"	30" x 30"	71½" (1816 mm)

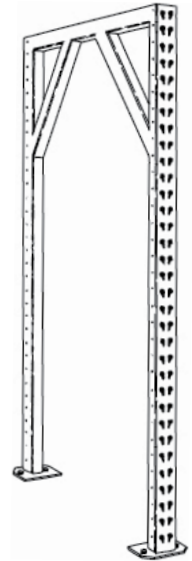
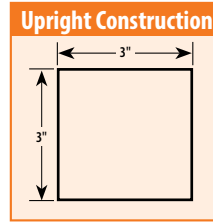

Maximum clear height minus uptilt equals figure in chart below

Shelf Depth	18"	20"	22"	24"	26"	28"	30"
Uptilt Clearance	6"	7"	8"	8"	9"	9"	10"

NOTE!
To preclude overturning, frame depth x 6 cannot exceed height of topmost loaded beam pair, unless all frames are properly anchored or braced externally.

Maxispan Beam

- Available in three heights for differing load capacities
- Sized to place Uprights on 3', 4', 6', 7' or 8' (914 mm, 1219 mm, 1829 mm, 2134 mm or 2438 mm) center lines
- Standard finish: Sahara or Blue Gray

MS2B(NH)(NL)-2

- MS2 Maxispan 2" OC (51 mm)
- B Beam
- NH Nominal Beam Height 3½", 5" or 6" (89 mm, 127 mm or 152 mm)
- NL Nominal Beam Length 36", 48", 72", 84" or 96" (914 mm, 1219 mm, 1829 mm, 2134 mm or 2436 mm)
- 2 2=1½" (41 mm)

Beam Length	Beam Height	Maximum Capacity per Beam Pair
36"	3½"	4,950 lbs
	5"	7,600 lbs
	6"	10,000 lbs
48"	3½"	4,950 lbs
	5"	7,600 lbs
	6"	10,000 lbs
72"	3½"	4,950 lbs
	5"	7,600 lbs
	6"	10,000 lbs
84"	3½"	4,950 lbs
	5"	7,600 lbs
	6"	10,000 lbs
96"	3½"	4,950 lbs
	5"	7,600 lbs
	6"	10,000 lbs

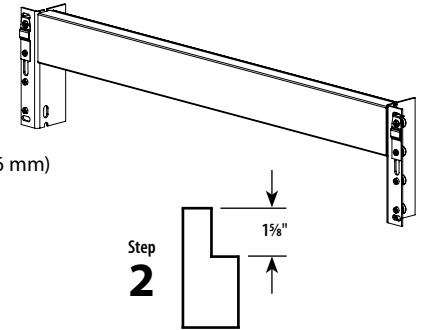

Maxispan Deck Support

- For 5/8" (16 mm) deck
- Formed, heavy-gauge steel with tabs fits into beam slots, providing support for regular-duty decking or, in heavy-duty applications, to tie beams together to prevent rotation
- Order by frame depth, in quantities shown in table
- Standard finishes: Sahara or Blue Gray

DSRMS-(ND)-1

- DSRMS Deck Support for Maxi Span
- ND Nominal Depth 24" to 48" in 6" increments (610 mm to 1219 mm in 152 mm increments)

Deck Supports per Beam Length		
Deck Type	Nominal Beam Length	Required Supports
Particle Board	36" to 72"	2
	84" to 108"	4
Wire Grid & Flow Through	36" to 48"	2
	60" to 96"	4

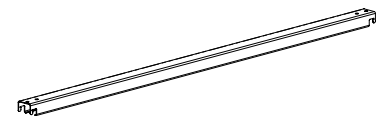

Maxispan Deck Support

- Formed, heavy-gauge steel with tabs fits into beam slots
- Supports regular-duty decking
- Ties heavy-duty decking beams together to prevent rotation
- Order by frame depth, in quantities shown in table
- Standard finish: Sahara or Blue Gray

MMSDS-(ND)

MMS Maxispan 2" OC (51 mm)
 DS Deck Support
 ND Nominal Frame Depth 36", 40", 44", 48" or 60"
 (914 mm, 1016 mm, 1118 mm, 1219 mm or 1524 mm)

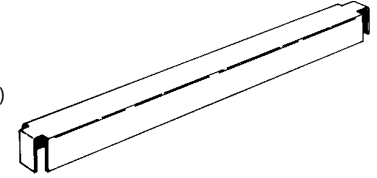

Deck Supports per Beam Length		
Deck Type	Nominal Beam Length	Required Supports
Heavy-Duty	36" to 96"	2

Maxispan Base Deck Beam

- Resists damage from carts and floor polishers
- Used at floor level to form kickplate
- Prevents trash from collecting under bottom deck
- Standard finishes: Sahara or Blue Gray

MS2BDB-(NL)

MS2 Maxispan
 BDB Base Deck Beam
 NL Nominal Length 36" to 96" in 12" increments
 (914 mm to 2438 mm in 305 mm increments)

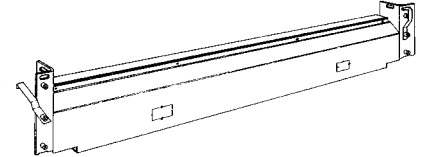

Pallet Rack Pallet Stop

- Heavy-gauge angle aids in pallet positioning
- Easily attaches to decking or beam with supplied hardware
- Standard finishes: Sahara or Blue Gray

PRPS-(NL)

PRPS Pallet Rack Pallet Stop
 NL Nominal Length 36" to 96" in 12" increments
 (914 mm to 2438 mm in 305 mm increments)



Maxispan Heavy-Duty Decking

- Unfinished 2" (51 mm) dimensional lumber provides high load capacity
- Use with 2" (51 mm) style beams only
- Order by upright depth
- Use with Maxispan Deck Supports [MMSDS-(ND)]

MMSHDD-(ND)

MMS Maxispan
 HDD Heavy-Duty Deck
 ND Nominal Frame Depth 36", 40" or 44",
 48", or 60" (914 mm, 1016 mm, 1118 mm,
 1219 mm or 1524 mm)

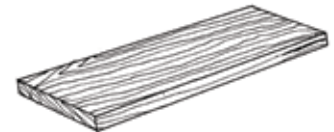

NOTE!
 Deck Supports are *NOT* included!

Deck Supports per Beam Length	
Nominal Beam Length	Required Supports
36" to 96"	2

Nominal Frame Depth	Actual Length
36"	44 $\frac{5}{8}$ "
40"	48 $\frac{5}{8}$ "
44"	52 $\frac{5}{8}$ "
48"	56 $\frac{5}{8}$ "
60"	68 $\frac{5}{8}$ "

Maxispan Waterfall Wire Grid Deck

- Sturdy-gauge wire, 5/16" (8 mm) in diameter, is welded on 3" (76 mm) grid centers to form decking
- Integrated supports eliminate standard deck supports
- Standard finishes: Silver Vein, Sahara, or Blue Gray

MSWFGD(ND)(NL)-3

- MS Maxispan
- WF Waterfall
- WGD Wire Grid Deck
- ND Nominal Frame Depth 36", 40", 48", 56" or 60"
(914 mm, 1016 mm, 1219 mm, 1422 mm or 1524 mm)
- NL Nominal Piece Length 24" to 48" in 6" increments
(610 mm to 1219 mm in 152 mm increments)
- 3 Grid Size 3" OC (76 mm)

Nominal Beam Length	Combine these Piece Lengths to equal beam length
36"	36"
48"	48"
60"	30" + 30"
72"	36" + 36"
84"	42" + 42"
96"	48" + 48"

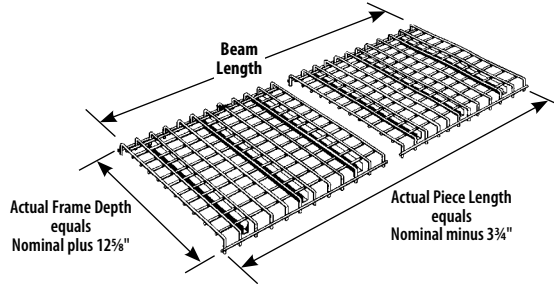

Maxispan Wire Grid Deck

- Sturdy-gauge wire, 5/16" (8 mm) in diameter, is welded on 3" (76 mm) grid centers to form decking
- Wire-grid piece length runs parallel to beam length
- Standard finishes: Silver Vein, Sahara or Blue Gray
- Order deck supports separately
- Use Maxispan Deck Support [DSRMS-(ND)-1] only

MSWMS(ND)(NL)-3

- MS Maxispan
- WMS Wire Grid Deck
- ND Nominal Frame Depth 36", 40", 44", 48" or 60"
(914 mm, 1016 mm, 1118 mm, 1219 mm or 1524 mm)
- NL Nominal Piece Length 24" to 48" in 6" increments
(610 mm to 1219 mm in 152 mm increments)
- 3 Grid Size 3" OC (76 mm)

Deck Type	Nominal Beam Length	Combine these Piece Lengths to equal beam length	Quantity of Deck Supports
One Piece Decks	36"	36"	2
	48"	48"	2
Two Piece Decks	60"	30" + 30"	4
	72"	36" + 36"	4
	84"	42" + 42"	4
	96"	48" + 48"	4

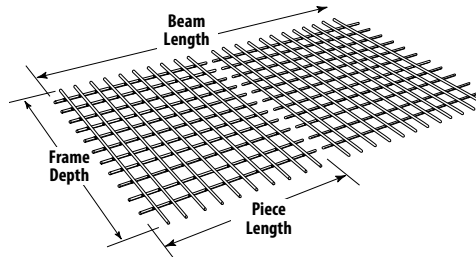

NOTE!
Deck Supports are NOT included!

Omega Merchandising System

Omega Merchandising System is best utilized as a complementary addition to our Pallet Rack system. The Omega Merchandising System adds functionality and efficiency, as an innovative solution in mass merchandising operations.

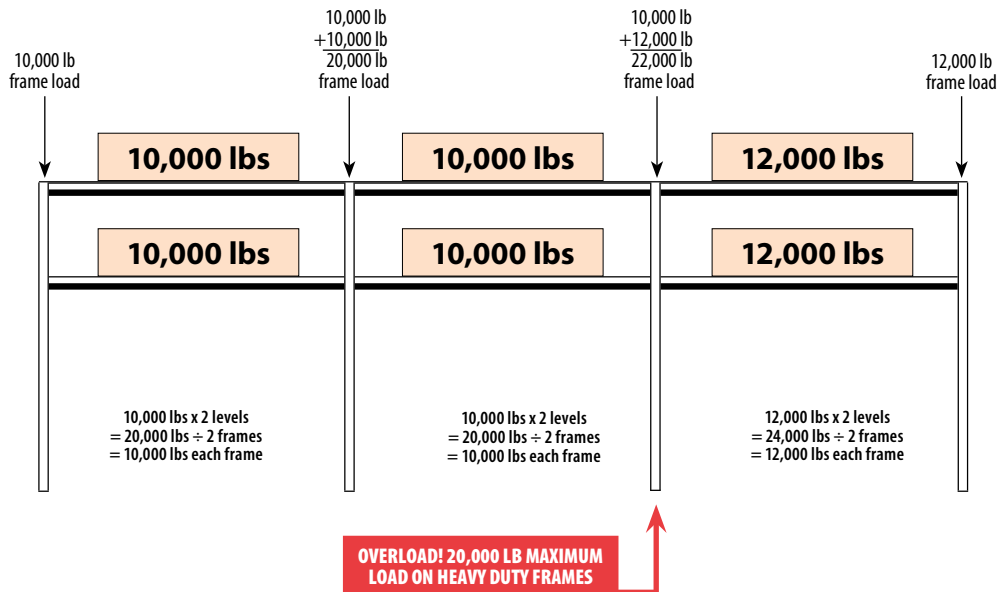
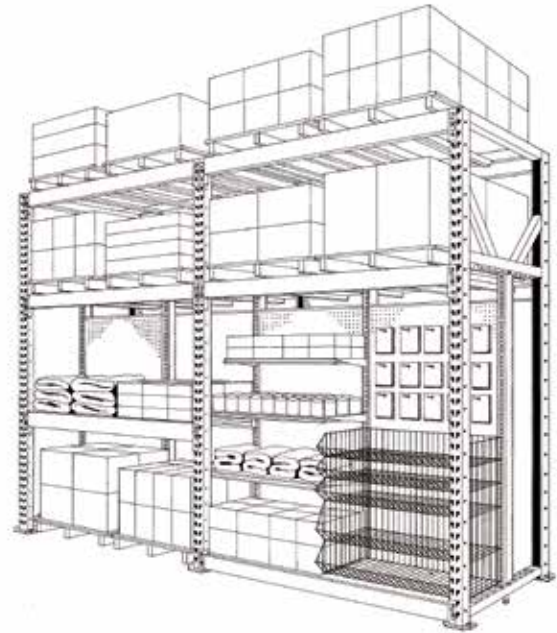
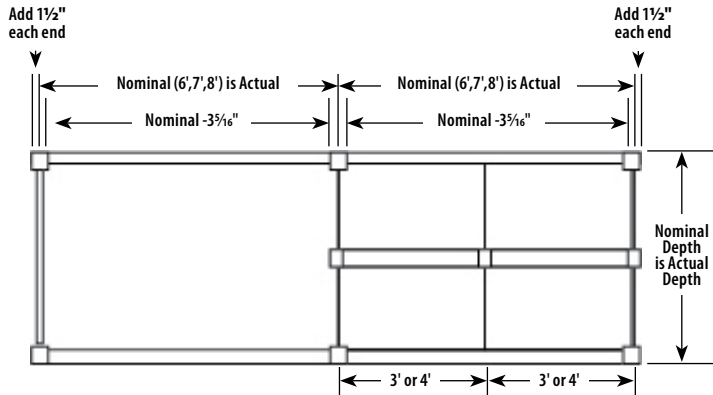

Omega Merchandising System

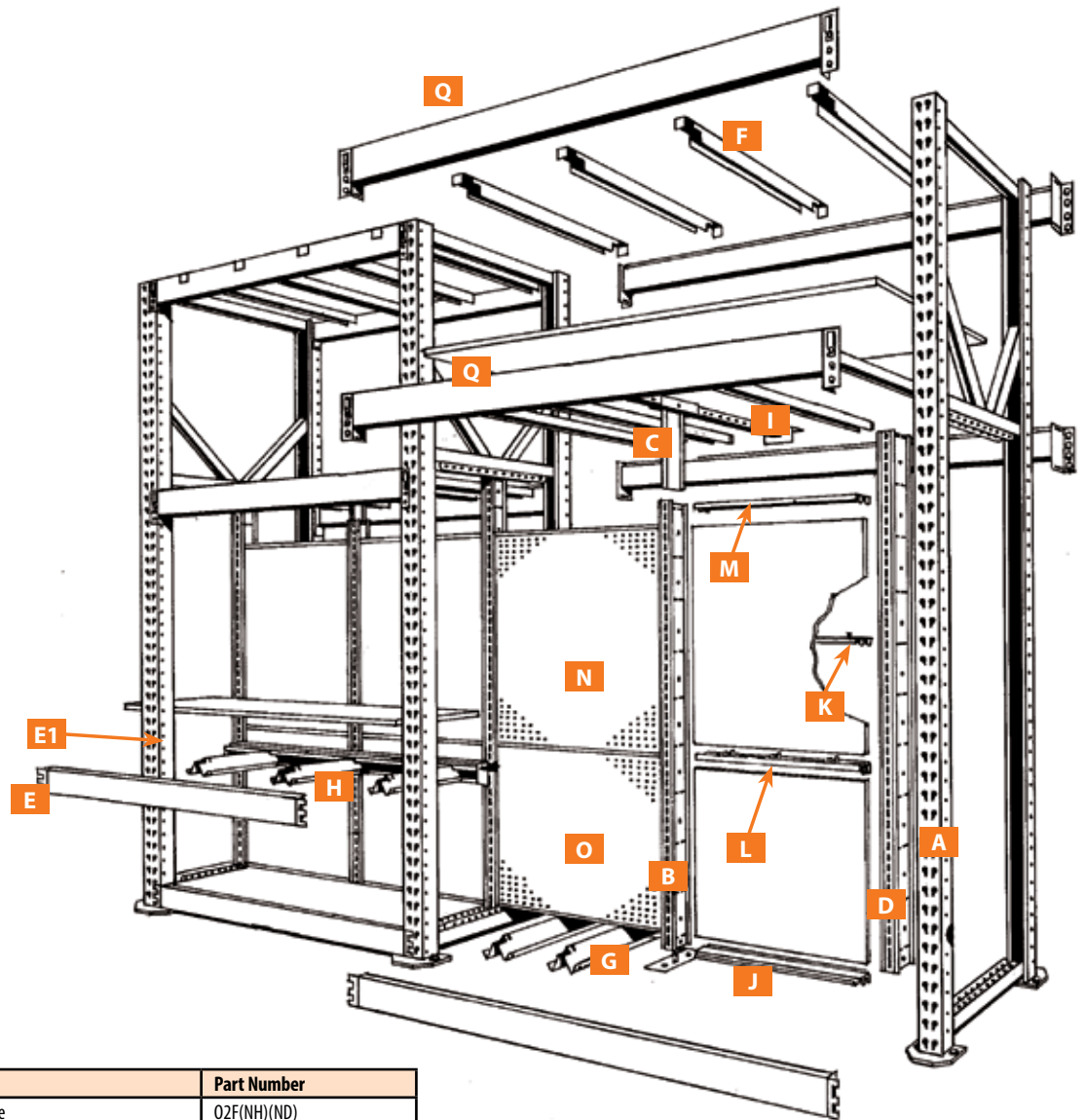

Description	Part Number
A Omega Frame	O2F(NH)(ND)
B Omega Upright	OU(NH)
C Omega Floating Upright Support Bracket	MOUSB-(ND)-F
D Omega Frame Upright	OFU(NH)
E Omega Display Beam Front	O2DBF(NL)HD
E1 Omega Display Beam Rear	O2DBR(NL)HD
F Omega Tubular Deck Support	MOTDSF(ND)
G Omega Deck Frame Support	OFDS(ND)
H Omega Deck Shelf Support	OSDS(ND)
I Pallet & Omega Rack Deck Supports	DSRPO-(ND)-1
J Lower Spanner	SL-(NW)
K Center Spanner	SC-(NW)
L Splicer Spanner	SS-(NW)
M Top Spanner	STL(NW)
N Pegboard Back Extension	BXP-(NH)(NW)
O Pegboard Back	BP-(NH)(NW)
P Back-to-Back Connector	PRBBC(ND)
Q Omega Box Beam	O2BB(NH)(NW)

A Omega Frame

- Slotted for beam adjustment in 2" (51 mm) increments
- Welded construction
- Upper and Lower channels accept Omega Upright with 1" (25 mm) adjustments
- Heavy-duty diagonals and footplates

NOTE!

To preclude overturning, frame depth x 6 cannot exceed height of topmost loaded beam pair, unless all frames are properly anchored or braced externally.

O2F(NH)(ND)

- O2F Omega Frame
- NH Nominal Height 96" to 144" in 24" increments (2438 mm to 3658 mm in 610 mm increments)
- ND Nominal Depth 36" to 48" in 6" increments (914 mm to 1,219 mm in 152 mm increments)

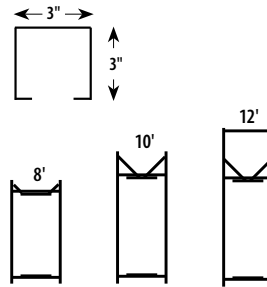

B Omega Upright

- Supports backs, spanners, and standard shelving and accessories
- Must be used with Omega Upright Support Bracket
- Must be anchored to the floor

OU(NH)

- OU Omega Upright
- NH Nominal Height 78" to 90" in 6" increments (1981 mm to 2286 mm in 152 mm increments)



C Omega Floating Upright Support Bracket

- Supports backs, spanners, and standard shelving and accessories
- Must be used with Omega Upright

MOUSBO-(ND)-F

- MOUSB Omega Upright Support Bracket Offset mot
- ND Nominal Depth 36" to 48" in 6" increments (914 mm to 1219 mm in 152 mm increments)
- F Floating



D Omega Frame Upright

- Use with Omega Frame when standard shelving, backs, or accessories are used

OFU(NH)

- OFU Omega Frame Upright
- NH Nominal Height 78" to 90" in 6" increments (1981 mm to 2286mm in 152 mm increments)



E E1 Omega Display Beam

- Uses Omega Deck Supports
- Accepts Wire Grid Decks or particle board decks

Beam Length x Beam Height	Maximum Capacity per Beam Pair
36" x 5"	3,000 lbs
48" x 5"	3,000 lbs
72" x 5"	3,000 lbs
84" x 5"	3,000 lbs
96" x 5"	3,000 lbs
106" x 5"	2,500 lbs

O2DB(OPT)(NL)HD

- O2DB Omega Display Beam 2" OC (51 mm)
- OPT F=Front
R=Rear
- NL Nominal Length 0447=4' (1219 mm)
0687=6' (1829 mm)
0807=7' (2134 mm)
0927=8' (2438 mm)
1047=9' (2743 mm)
- HD Heavy-Duty

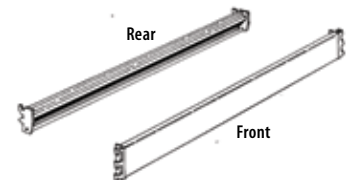

F Omega Tubular Deck Support

- Load-bearing pallet support
- Fits flush with top of beam
- Rests on top of beam step
- One pair required per pallet to be used
- Load capacity is 5,000 lbs per pair

MOTDSF(ND)

MOTDS Omega Tubular Deck Support
 F Flush
 ND Nominal Depth 36", 42" or 48"
 (914 mm, 1066 mm or 1219 mm)

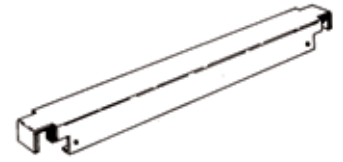

G Omega Deck Frame Support

- To be used with full-frame depth decks and two front-display beams only

OFDS(ND)

OFDS Omega Deck Frame Support
 ND Nominal Depth 36" to 48" in 6" increments
 (914 mm to 1066 mm in 152 mm increments)



Deck Supports per Beam Length		
Deck Type	Nominal Beam Length	Required Supports
Particle Board	36" to 48"	2
	60" to 96"	3
	108"	4
Wire Grid & Flow Through	36" to 48"	2
	60" to 96"	4
	108"	6

H Omega Deck Shelf Support

- Use only with Omega Deck Shelf
- Use only with a front and rear-display beam

OSDS(ND)

OSDS Omega Deck Shelf Supports
 ND Nominal Depth 18" to 34" in 2" increments
 (457 mm to 864 mm in 51 mm increments)



Deck Supports per Beam Length		
Deck Type	Nominal Beam Length	Required Supports
Particle Board	36" to 48"	2
	60" to 96"	3
	108"	4
Wire Grid & Flow Through	36" to 48"	2
	60" to 96"	4
	108"	6

I Pallet & Omega Rack Deck Supports

- For 5/8" (16 mm) deck
- Formed, heavy-gauge steel with tabs fits into beam slots, providing support for regular-duty decking or, in heavy-duty applications, to tie beams together to prevent rotation
- Order by frame depth, in quantities shown in table
- Standard finishes: Sahara or Blue Gray

DSRPO-(ND)-1

DSRPO Pallet Rack Deck Supports
 ND Nominal Depth 24" to 48" in 6" increments
 (610 mm to 1219 mm in 152 mm increments)

Deck Supports per Beam Length		
Deck Type	Nominal Beam Length	Required Supports
Particle Board	36" to 72"	2
	84" to 108"	4
Wire Grid & Flow Through	36" to 48"	2
	60" to 96"	4
	108"	6

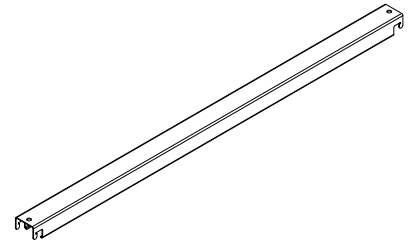

J Lower Spanner

- Snap-in spanner secures uprights at equal spacing and supports back panels
- Electrical knockouts

SL-(NW)

SL Lower Spanner
 NW Nominal Width 3' or 4'
 (914 mm or 1219 mm)

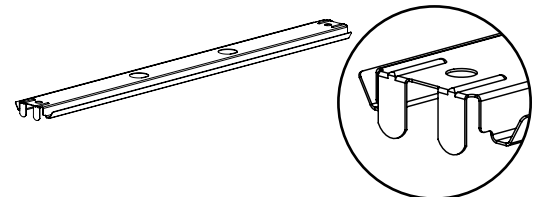

K Center Spanner

- Galvanized snap-in spanner assures back panel rigidity
- Electrical and Telescoping Upright knockouts
- Galvanized only

SC-(NW)

SC Center Spanner
 NW Nominal Width 3' or 4'
 (914 mm or 1219 mm)

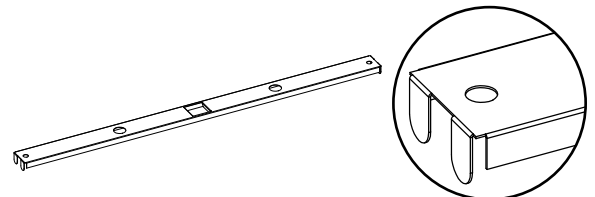

L Splicer Spanner

- Splicer spanner joins two back panels in sections 78" (1981 mm) and above
- Electrical and Telescoping Upright knockouts

SS-(NW)

SS Splicer Spanner
 NW Nominal Width 3' or 4'
 (914 mm or 1219 mm)

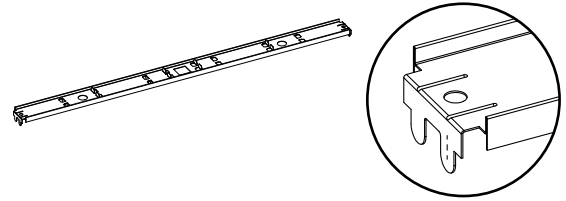

M Top Spanner

- "Snap-in" spanner secures uprights at equal spacing; traps back panels and trims top of section
- Electrical and Telescoping Upright knockouts

STL-(NW)

STL Top Spanner
 NW Nominal Width 3' or 4'
 (914 mm or 1219 mm)

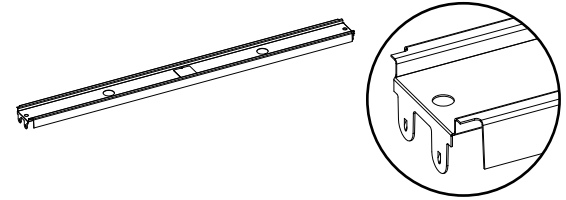

N Pegboard Back Extension

BXP-(NW)(NH)

BX Extension Back
 P Pegboard
 NW Nominal Width 3' or 4'
 (914 mm or 1219 mm)
 NH Nominal Height 6" to 54" in 6" increments
 (152 mm to 1372 mm in 152 mm increments)

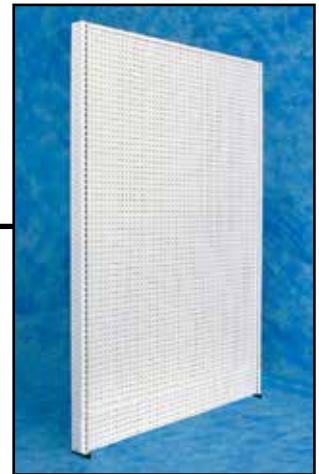

O Pegboard Back

- Back nominal height (NH) should match Basic Upright height

BP-(NW)(NH)

B Back
 P Pegboard
 NW Nominal Width 3' or 4'
 (914 mm or 1219 mm)
 NH Nominal Height 36" to 72" in 6" increments
 (914 mm to 1829 mm in 152 mm increments)

P Pallet Rack Back-to-Back Connector

- Heavy-gauge connector keeps back-to-back runs properly spaced
- Use two connectors on frames up to 96" (2438 mm) high; three on taller units
- Hardware included
- Standard finishes: Sahara or Blue Gray

PRBBC(ND)

PR Pallet Rack
 BBC Back-to-Back Connector
 ND Nominal Back Spacing 6" to 12" in 1" increments
 (152 mm to 305 mm in 25 mm increments)

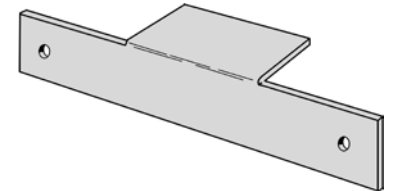

Q Omega Box Beam

- Can accommodate particle board, Wire Grid Deck, or 2" (51 mm) dimensional board decking
- Use only with Omega Tie Bars and Omega Deck Top

O2BB(NH)(NW)

O2BB Omega Box Beam
 NH Nominal Height 50" (1270 mm)
 NW Nominal Width 36" to 108" in 12" and 24" increments (1981 mm to 2743 mm in 305 mm and 610 mm increments)



Beam Length x Beam Height	Maximum Capacity per Beam Pair
36" x 5"	7,600 lbs
48" x 5"	7,600 lbs
72" x 5"	7,600 lbs
84" x 5"	7,600 lbs
96" x 5"	7,600 lbs
106" x 5"	6,150 lbs

Omega Wood & Wire Decks

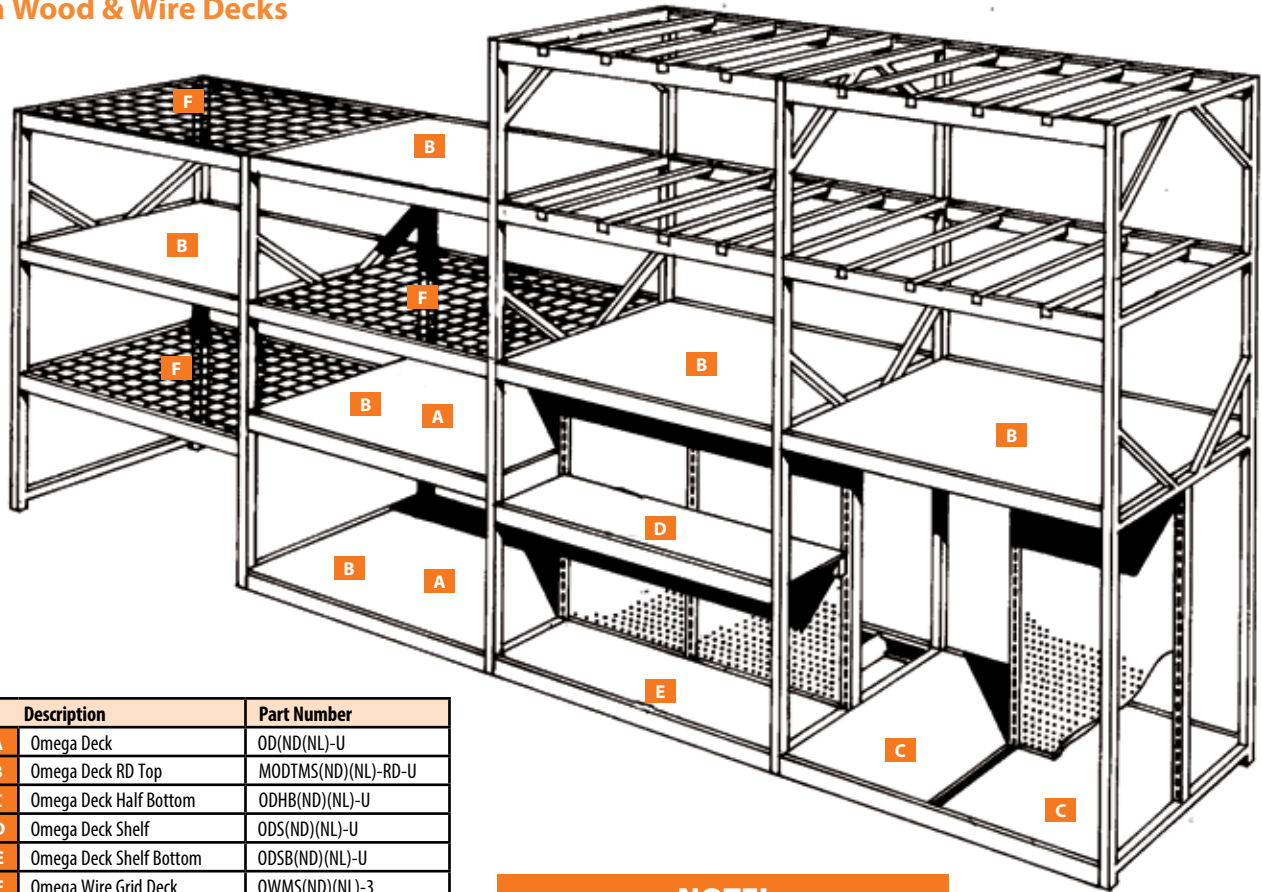

Description	Part Number
A Omega Deck	OD(ND)(NL)-U
B Omega Deck RD Top	MODTMS(ND)(NL)-RD-U
C Omega Deck Half Bottom	ODHB(ND)(NL)-U
D Omega Deck Shelf	ODS(ND)(NL)-U
E Omega Deck Shelf Bottom	ODSB(ND)(NL)-U
F Omega Wire Grid Deck	OWMS(ND)(NL)-3

NOTE!
When using the Omega Upright, do not stack lower levels via forklift—hand stack only! Upper levels with box beams permit forklift usage.

A Omega Frame Deck

- Use as a full-frame-depth deck at the bottom or intermediate level
- Uses Omega Deck Frame Support [OFDS(ND)]
- Cannot be used in sections where backs are used

Deck Supports per Beam Length	
Beam Length	Supports
36" or 48"	2
72", 84", or 96"	3
108"	4

OD(ND)(NL)-U

- OD Omega Deck
- ND Nominal Frame Depth 34", 40" or 46" (914 mm, 1016 mm or 1168 mm)
- NL Nominal Beam Length 36", 48", 72", 84", 96" or 108" (914 mm, 1219 mm, or 1829 mm, 2438 mm or 2743 mm)
- U Unsealed

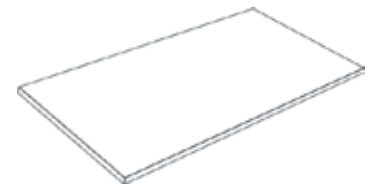

NOTE!
Deck Supports are NOT included! Order Omega Deck Support [OFDS-(ND)]

B Omega Deck Regular-Duty Top

- Full-frame-width deck for use only with Omega Box Beams and Tie Bars
- Industrial-grade 5/8" particle board
- Uses Pallet and Omega Deck Rack Support [DSRPO-(ND)-1]

Deck Supports per Beam Length	
Beam Length	Supports
36", 48" or 72"	2
84", 96" or 108"	4

MODTMS(ND)(NL)-RD-U

- MODTMS Omega Deck Top
- ND Nominal Frame Depth 34", 40" or 46" (914 mm, 1016 mm or 1168 mm)
- NL Nominal Beam Length 36", 48", 72", 84", 96" or 108" (914 mm, 1219 mm, 1829 mm, 2438 mm or 2743 mm)
- RD Regular-Duty
- U Unsealed

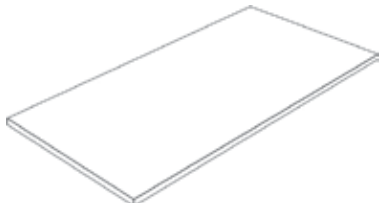

NOTE!
Deck Supports are NOT included! Order Pallet & Omega Rack Deck Supports [DSRPO-(ND)-1] .

C Omega Deck Half Bottom

- Full-frame-depth deck on two Omega Front Beams and the OFDS(ND)-HD Deck Support
- Fits between the Omega Frame Upright and the Omega Upright
- Use with or without back panels
- Uses Omega Deck Frame Support [OFDS(ND)]

Deck Supports per Beam Length	
Beam Length	Supports
36" or 48"	2
72", 84", or 96"	3
108"	4

ODHB(ND)(NL)-U

- ODHB Omega Deck Half Bottom
- ND Nominal Frame Depth 34", 40" or 46"
(914 mm, 1016 mm, or 1168 mm)
- NL Nominal Beam Length 36" or 48"
(914m or 1219 mm)
- U Unsealed

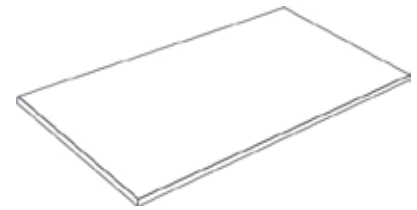

NOTE!
Deck Supports are NOT included!
Order Omega Deck Support [OFDS(ND)].

D Omega Deck Shelf

- Partial-frame-depth deck fits one Omega Beam Front Display and one Omega Beam Rear Display plus Omega Shelf Deck Support
- Only use at intermediate levels
- Fits between Aisle Display Beam, Omega Upright, and back panel
- Uses Omega Deck Frame Support [OFDS(ND)]

Deck Supports per Beam Length	
Beam Length	Supports
36" or 48"	2
72", 84", or 96"	3
108"	4

ODS(ND)(NL)-U

- OD Omega Deck Shelf
- S Shelf
- ND Nominal Frame Depth 18" to 34" in 2" increments
(457 mm to 864 mm in 51 mm increments)
- NL Nominal Beam Length
- U Unsealed

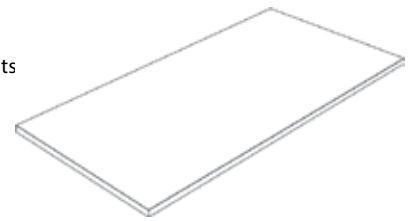

NOTE!
Deck Supports are NOT included!
Order Omega Deck Support [OSDS(ND)].

E Omega Deck Shelf Bottom

- Partial-frame-depth Deck
- Use with two Omega Front Beams and Omega Deck Frame Support
- Fits between Aisle Display Beam, Omega Uprights, and back panel
- Uses Omega Deck Frame Support [OFDS(ND)]

Deck Supports per Beam Length	
Beam Length	Supports
36" or 48"	2
72", 84", or 96"	3
108"	4

ODSB(ND)(NL)-U

- OD Omega Deck
- SB Shelf Bottom
- ND Nominal Frame Depth 18" to 34" in 2" increments
(457mm to 864 mm in 51 mm increments)
- NL Nominal Beam Length 36" or 48"
(914m or 1219 mm)
- U Unsealed

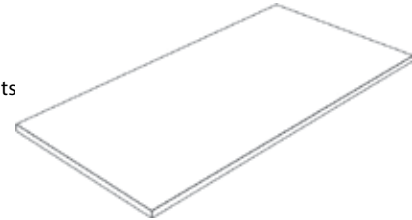

NOTE!
Deck Supports are NOT included!
Order Omega Deck Support [OFDS(ND)].

F Omega Wire Grid Decks

- Pieced for ease of handling
- 5/16" (8 mm) sturdy-gauge wire welded on 3" (76 mm) grid centers
- Standard finishes: Silver Vein, Sahara or Blue Gray
- Order deck supports separately
Both 72" (1829 mm) and 108" (2743 mm) decks come as four pieces
- Uses Pallet and Omega Deck Rack Support [DSRPO-(ND)-1]

Deck Supports per Beam Length	
Beam Length	Supports
36" or 48"	2
60", 72" or 96"	4
108"	6

OWMS(ND)(NL)-3

- O Omega
- WMS Wire Grid Deck
- ND Nominal Frame Depth 36", 42" or 48"
(914 mm, 1067 mm or 1219 mm)
- NL Nominal Piece Length 24", 36", 48", 60",
72", 96" or 108" (610 mm, 914 mm, 1220 mm,
508 mm, 1829 mm, 2438 mm or 2743 mm)
- 3 Grid Size 3" OC (76 mm)

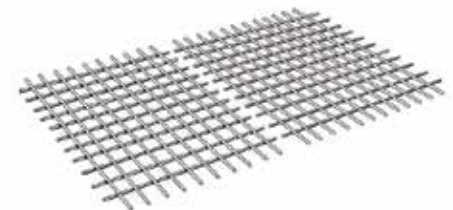

NOTE!
Deck Supports are NOT included!
Order Pallet Rack Deck Support [DSRPO-(ND)-1].

Omega Molding Rack

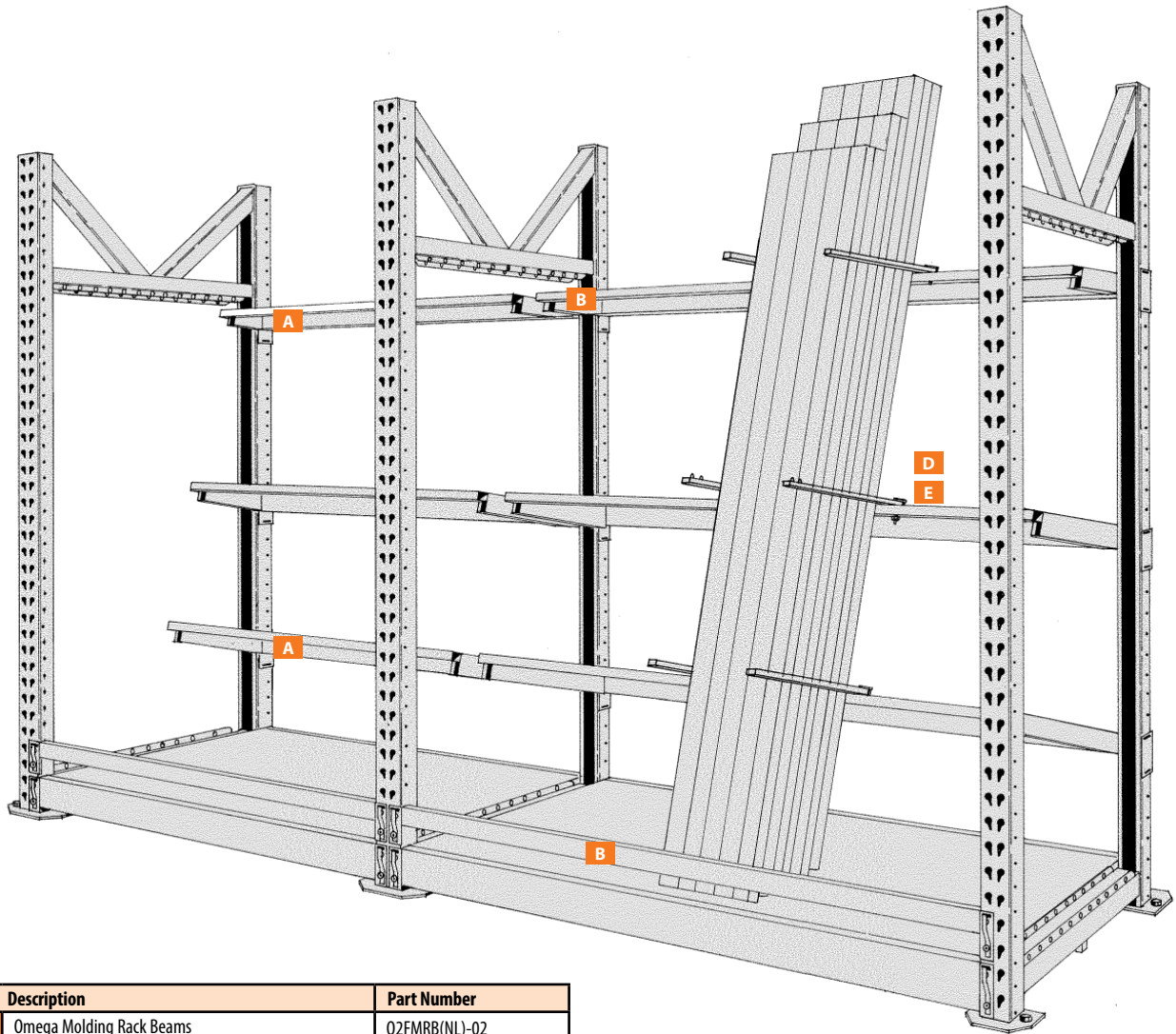

Description	Part Number
A Omega Molding Rack Beams	O2FMRB(NL)-O2
B Omega Rack Beam	O2DBF(NL)-LD
C Omega Molding Rack Beam Kit (not shown)	O2FMRK(NL)
D Vertical Divider Arms *	VDA-(NL)(TYPE)
E Threaded Vertical Divider Arms *	TVDA-(NL)(TYPE)

*Choose divider arm type based on merchandising needs

A Omega Molding Rack Beams

- Standoffs are predetermined for optimum product angle

O2FMRB(NL)-(OPT)

O2 Omega 2" OC (51 mm)
 FMRB Molding Rack Beams
 NL Nominal Width
 0327=36" (914 mm)
 0447=48" (1219 mm)
 0687=72" (1829 mm)
 0807=84" (2134 mm)
 0927=96" (2438 mm)
 1047=108" (2743mm)

OPT Standoff
 02 = 2" (51 mm)
 08 = 8" (203 mm)
 14 = 14" (356 mm)

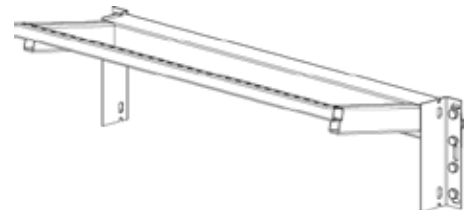

B Omega Retainer Beam

- Install into the Omega uprights
- Helps prevent merchandise from falling off shelf

O2DBF(NL)-LD

- O2 Omega 2" OC (51 mm)
- DBF Retainer Beam
- NL Nominal Beam Length 3', 4', 6', 7', 8' or 9' (914 mm, 1219 mm, 1829 mm, 2134 mm, 2438 mm or 2743 mm)
- LD Light-Duty



C Omega Molding Rack Beam Kit

- Beam Kits include top, middle, bottom, and front beams
- Mount front beam one slot higher than rear beam for a sloped deck; adding a front retainer beam keeps molding in place
- Secure beams by bolting through frames in all situations
- Individual Beams:
 - Top Beam—2" standoff
 - Middle Beam—8" standoff
 - Bottom Beam—14" standoff
- Standard finishes: Sahara or Blue Gray

O2FMRK(NL)

- O2 Omega 2" OC (51 mm)
- FMRK Molding Rack Beam Kit
- NL Nominal Beam Length 3', 4', 6', 7', 8' or 9' (914 mm, 1219 mm, 1829 mm, 2134 mm, 2438 mm or 2743 mm)

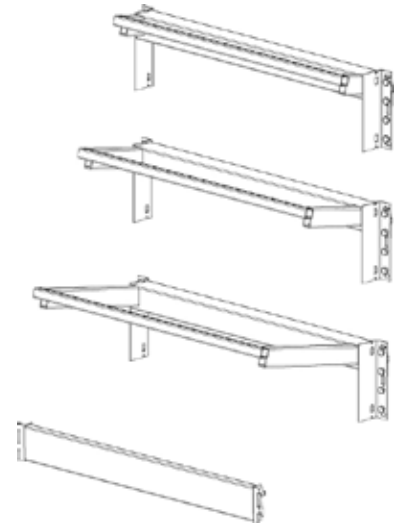

D Vertical Divider Arms

- Attaches straight out from crossbar or at a 45° angle in either direction
- Regular-Duty Divider Arms 3/8" (10 mm) diameter with red neoprene safety tip
- Heavy-Duty Divider Arms 1" (25 mm) square tubing with vinyl safety cap
- Standard finishes: Sahara or Blue Gray

VDA-(NL)(TYPE)

- VDA Vertical Divider Arms
- NL Nominal Divider Length
 - R=10"-18" (254 mm-457 mm)
 - H=20"-30" (508 mm-762 mm)
- TYPE R=Regular-Duty
H=Heavy-Duty

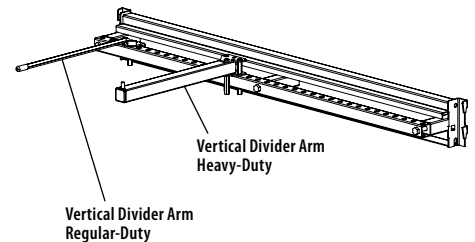

E Threaded Vertical Divider Arms

- Attaches straight out from Vertical Divider Bar or at a 45° angle in either direction
- Arms may be mounted to front and/or rear of standoff bars
- Regular-duty divider arms 3/8" (10 mm) diameter with red neoprene safety tip
- Heavy-duty arms 1" (25 mm) square tubing with vinyl safety cap
- Threaded option locks arm and prevents accidental dismounting
- Standard finishes: Sahara or Blue Gray

TVDA-(NL)(TYPE)

- TVDA Threaded Vertical Divider Arm
- NL R=6"-20" in 2" increments (152 mm-508 mm in 51 mm increments)
H=12"-30" in 2" increments (305 mm-762 mm in 51 mm increments)
- TYPE R=Regular-Duty
H=Heavy-Duty

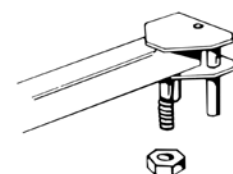
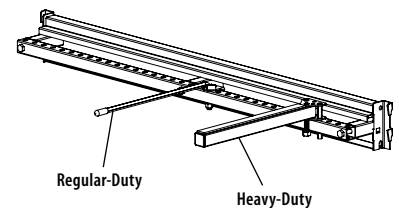

Omega Garden Tool Front Beam

- Heavy-Duty Beam Body
- Keyhole Slotting to fit Wide Span Garden Display Hook

O2GTFB-(NW)

O2GTFB Omega Garden Tool Front Beam

NW Nominal Width

0327=36" (914 mm)

0447=48" (1219 mm)

0567=60" (1524 mm)

0687=72" (1829 mm)

0807=84" (2134 mm)

0927=96" (2438 mm)

1047=108" (2743 mm)

**Wide Span Single Hook Display**

- Wide Span accessory can be used with Omega

WSSHD-24

WSSHD Wide Span Single Hook Display

24 24" (610 mm)

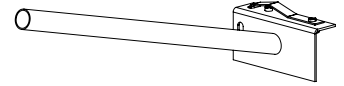
**Wide Span Garden Tool Double Hook**

- Wide Span accessory can be used with Omega

WSGTDH-24

WSGT Wide Span Garden Tool

DH Double Hook

24 24" (610 mm)

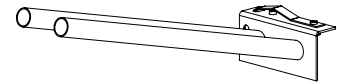
**Omega Light Mounting Kit**

- Attaches light to Omega Box Beam

OLMK-2

OLMK-2 Omega Light Mounting Kit

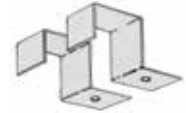

Anchor Wedge

- Body: Case hardened AISI 1020/1040 or 10821 Carbon Steel
- Finish: Zinc plating per ASTM B633, SC1, Type III or B695, Class 65, Type 1

ANCWEDGE-(SIZE)(QTY)(OPT)

- ANC Anchor
- WEDGE Wedge
- SIZE 14=1/4", 38=3/8" or 12=1/2"
(6 mm, 10 mm or 13 mm)
- QTY 50=Pack of 50
Blank=Single Quantity
- OPT WM=Walmart

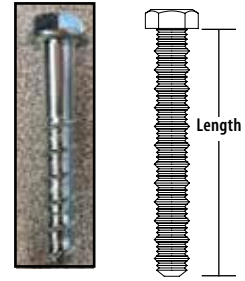

Kwik Bolt Hilti

- 1/4" X 3" Anchor Bolt

KB-HUS-EZ1/4X3

- KBHUS Kwik Bolt HUS
- EZ Easy
- 1/4 1/4" (6 mm)
- 3 3" (76 mm)



Anchor Bolt

- Hex nut
- 1/2" Diameter

KB-TZ1/2X(LENGTH)-(QTY)

- KB Kwik Bolt
- TZ Hilti TZ
- 1/2X 1/2" Diameter
- LENGTH Bolt Length
33/4=3 3/4"
41/2=4 1/2"
- QTY Blank=1 Pack
4=4 Pack
20=20 Pack



Anchor Bolt

- Hex nut
- 3/8" Diameter

KB-TZ3/8X(LENGTH)-(QTY)

- KB Kwik Bolt
- TZ Hilti TZ
- 3/8X 3/8" Diameter
- LENGTH Bolt Length
3=3"
33/4=3 3/4"
5=5"
- QTY Blank=1 Pack
4=4 Pack
10=10 Pack
20=20 Pack



Anchor Bolt

- Hex nut

MSF-ANC.25X(LENGTH)

MSF-ANCAnchor Bolt
 .25XBolt Diameter
 LENGTHBolt Length
 1.75=1.75"
 2.25=2.25"

**Seismic Floor Anchor Expansion Bolt**

- 1 or 50 pack
- Bolt Exp 3/8-16X3 1/2, ICBO Cert

SFA-EB-(PACK)

SFA Seismic Floor Anchor
 EB Expansion Bolt
 PACK 1=1
 50=50 Pack

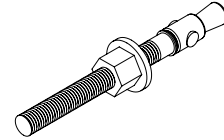
**Seismic Floor Anchor Expansion Bolt**

- 1/2-13 X 3 3/4

SFA-EB-12-334

SFA Seismic Floor Anchor
 EB Expansion Bolt
 12-334 1/2-13 X 3 3/4

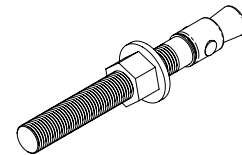

Prices All prices are subject to change without notice. Every effort will be made to give advance notice of any increase through notification from the home office. The customer will receive an acknowledgement showing prevailing prices at the time the order is processed. State or other sales or use taxes, freight and surcharges will be charged when applicable. Freight quotes may be provided based upon information available at time of quote, but are not guaranteed. Active freight charges will be billed if applicable. When market conditions dictate, a surcharge may be implemented. All quotations automatically expire at the end of 30 days.

Terms Cash in advance prior to production or net 30 days if open account status is approved by Madix Credit Department. MasterCard, Visa, and American Express are accepted.

Acceptance All orders, contracts, and agreements are subject to Madix's acceptance and approval. Madix shall not be liable for any delay in the performance of any order, contract, in the delivery of any goods, or for any damages resulting from such delay, when such delay is directly or indirectly caused by or due to fire, flood, accident, riot, act of God, war, governmental decree or order, strike, labor difficulties, shortage of labor, fuel, power, material or supplies, transportation delay or any other delay or causes (whether or not similar to any of those herein before specified) beyond our reasonable control. Order acceptance will be per the conditions and terms outlined in Madix's acknowledgement. Mailing of the acknowledgement will signify Madix's acceptance of the order.

Minimum Charge Orders are subject to a minimum charge of \$50.00 net (merchandise only) per shipping destination.

Changes and Cancellations Customer requested changes and cancellations are subject to approval by Madix. Every reasonable effort will be made to accommodate these requests without additional cost to the customer. Any manufacturing or engineering costs incurred will be charged to the customer. Orders produced and delayed for more than one week may incur charges for demurrage, unloading, or other storage costs. Madix will advise customers of the estimated charges at the time changes or cancellations are made.

Shipments Method and route of shipment are at Madix's discretion unless Madix is furnished with complete shipping instructions at least ten (10) days before the scheduled shipping date. Freight is FOB/EXW Madix shipping point.

Freight Claims For common carrier shipments, claims must be made directly with the carrier by the recipient. Listed are the types of losses which may occur, and your responsibility in handling them:

Loss of Freight: It is the receiver's responsibility to count the freight at the time of delivery. Any exception must be noted on the carrier's delivery receipt at time of delivery.

Damage of Freight: As with a loss of freight, damage of freight must be noted on the carrier's delivery receipt at the time of delivery. It is the receiver's responsibility to make sure that the freight is inspected for visible damage and that the number of pieces damaged is marked on the carrier's delivery receipt. Failure to note visible damage at the time of delivery will result in non-payment of a damage freight claim. Salvage must be held for the carrier.

Concealed Damage: If goods are received in apparently good condition but there is concealed damage, it is the customer's responsibility to contact your Madix Service Representative within 15 calendar days from delivery. Customer must keep the product and the packaging so that an inspection may be conducted by the carrier. Failure to handle a concealed damage claim in this manner could greatly reduce the amount recovered from the carrier.

Returned Goods Returned Goods requests must be submitted to Madix, Inc. within 60 days after receipt of product. Authorization must be in writing on Madix's RGA (Return Goods Authorization) form. Goods must be received within 30 days of RGA issue date for credit. Customer is responsible for delivery of authorized returns to Madix designated location in condition originally received. Only Code A products finished in returnable colors as indicated on the finish policy pages will be considered for return, and only items in unused, in resalable condition, and in the original packaging. No special size, color, or specially manufactured parts or products are eligible for return unless sent to the customer as the result of an error by Madix. Only merchandise listed on the RGA will be accepted for conditional return. Credit will not be issued for that portion of merchandise that is not considered resalable. A handling and restocking charge of 25% of the invoice price will be charged for all approved returns. Submit requests to your Madix Sales Representative or Customer Service Department prior to returning any merchandise. All returns must be have the customer name and Madix RGA number prominently displayed on each package. Product to be shipped prepaid at customer's expense unless prior approval has been received from an authorized Madix Representative.

Warranty We warrant to the original purchaser that all products manufactured by Madix are free from defects in material and workmanship. This warranty is invalid if products or parts are modified or used in a manner other than the intended purpose. Our obligation under this warranty is limited to repairing or replacing of any part or parts which shall, within one (1) year after delivery to the original purchaser, be demonstrated to be defective under normal use and service. This warranty is in lieu of all other warranties, expressed or implied, and of all other obligations or liabilities of any kind on Madix's part, and no modification of this warranty shall be valid or binding unless in writing and signed by an officer of Madix, Inc.

Production Madix fixtures are manufactured utilizing the most current technology of highly automated systems with process control techniques. Skilled craftsmanship, combined with automatic presses, roll forming machines, multi-spot welders, conveyers, finishing equipment and thorough inspections produce store fixtures of the highest quality.

Upright Carefully engineered of heavy gauge, high quality steel components, the UPRIGHT is slotted one inch on center for maximum flexibility, shelf adjustability and use of available space. Standard heights range from 36" through 96" with built-in leveler. For the finishing touch at the end of the shelving run, the snap-on UPRIGHT END COVER is made of durable, scuff and impact resistant plastic or heavy gauge metal. The UPRIGHT CAP, made of high impact plastic, has provision for a sign holder.

Base Shoe The five inch low BASE SHOE features exclusive "I" beam design, engineered of projection welded high strength steel parts insuring maximum load capacity. Snaps securely into upright with leveler and electrical access allowing for quick error free installation. For the finished look, the one piece slip on BASE END COVER is made with a high impact plastic nose reinforcement to protect base shelf tag molding.

Spanners Snap-in support SPANNERS keep uprights at equal spacing and hold the back panels rigid. Each spanner has knockouts for electrical access and telescoping uprights.

Back Panels High density hardboard BACKS fit flush to the face of the upright. A wide variety of finishes include solid, pegboard, and wood grain in a wide assortment of optional colors. Mirrors and open backs are also available.

Kickplate Fully floating feature of kickplate allows flush fit against uneven floors, snaps in and out without disturbing base shelf for easy cleaning. Convenient knockout accommodates electrical access.

Base and Upper Shelves Steel base shelves feature lock tabs to insure quick installation and precision alignment. A double row of 1/4" inch perforations on the front and rear edge makes any form for binning possible. Slim bracket, high tensile design with flat or 15 degree downslope upper shelf positions allow for maximum merchandise visibility. Integrally formed price tag molding accommodates 11/4" tag. Upper shelves available in 8", 10", 12", 14", 16", 20", 22", 24", 26", 28", and 30" depths. Base shelves available in 12", 14", 16", 18", 20", 22" 24", 26", 28" and 30" depths.

Shelf Loading The recommended load capacity for upper shelves is based on evenly distributed weight. Capacities are reduced by 35% when front half is loaded and reflect rated maximum load. Load capacities are shown in the General Information Section under Shelf Loading.

Baked Enamel, Powder Coat Finishes All metal parts are finished with a specially formulated high solids or powder which are electrostatically bonded in a unique multi-stage process, to insure the highest quality finish. Aerosol cans of Touch-up paint are available in Madix's standard and optional colors. FAA regulations prohibit the shipment of this product by air or in export containers by air or ocean to countries outside the United States.

Product Maintenance When necessary to clean Madix shelving, use a non-abrasive mild detergent and warm water, followed by thorough drying. The use of a cloth made of a soft white cotton material is strongly recommended. The use of cleaning products that contain abrasive, bleach, or strong solvents, such as ketones, ethers, etc. will result in damage to the finish. The damage is most severe when these harsh cleaning agents are used on colors which contain leafing aluminum pigment such as powder chrome, silver vein, and other "vein" type finishes. The aluminum in these coatings resides at the surface of the finish and is therefore susceptible to damage by the harsh cleaning agents. As an alternative to the mild detergent, cleaners with ingredients similar to those found in products such as 409, Fantastik, and Simple Green can be used. Caution! Cleaners having ingredients similar to those found in Ajax, Borax, Comet, etc. should be avoided as finish damage could result.

Codes In your planning stage, consult with local municipal engineers to determine what codes and restrictions will be applicable in the locations where the shelving will be used. Codes may include: state, local, fire, building, and health and safety codes. Seismic requirements may apply in some locations. For example, in most locations fire codes state that fixtures need to be at least 18 inches below the sprinklers.

Shelving Selection Take into consideration the load that is expected not only on each shelf but also on the unit as a whole. Take into account the upright capacity. Refer to the load capacity information that is in the Madix Standard Catalog. Madix shelves are rated using an evenly distributed load. Do not install shelves or accessories that extend beyond the depth of the Base Shelves. Consider making the Base Shelves and low height fixtures a contrasting color from the floor's color to prevent potential tripping hazards. Do not use Madix parts or accessories for any purpose other than originally intended by Madix.

Shelving Installation Initial installation or relocation of Madix shelving should be supervised by qualified personnel. Madix products should be installed according to Madix's specifications. Madix's installation sequence must be followed for assembly and leveling. An improperly installed store fixture has a poor appearance and may cause a dangerous condition. Be especially careful when leveling fixtures with offset loads in which one side of the fixture has a considerably heavier load than the other side. Dismantling and reassembling used Madix shelving can be dangerous if the installers who are doing the work leave out parts, use damaged parts, or do not reassemble the product by Madix's specifications. Do not alter, modify, or structurally change any shelving component. Do not move assembled shelving. Only parts and accessories that are produced and supplied by Madix are covered by the Madix warranty. Do not assemble Madix fixtures with parts from other manufacturers. Under no circumstances should you use damaged parts. When assembling Gondola/Wall Shelving, install Kickplates to protect the Base Shoes from floor cleaning equipment and to offset the possible bumping and misalignment of the shelving runs. Do not install shelves or accessories on the sides of wall sections or any section that is not supported by Base Shoes. Use caution when handling and transporting shelving parts. Be careful when cutting shrink wrap from pallets because the shelving parts can dislodge from the wrap and fall. Cut the wrap gradually from the top, only as much as you need to remove the product from the top. Two common hazards while installing store fixtures are: employees hurting themselves with improper types of box cutters and employees putting boxes on the floor and then tripping over them.

Anchoring and Floors Depending on code requirements and Madix's specifications, some products must be anchored to the walls and/or floors. Do not lean tall or heavy objects against unanchored shelving systems. Retailers must consider the type of floor upon which the shelving will be installed.

Impact Loading Impact during the loading and unloading of merchandise can create an adverse loading situation and may result in damage to or failure of the Madix shelving. Do not walk or climb on Madix shelving.

Overturning Overloading the top portion of the shelving, non-uniform loading, out-of-plumb installation, and impact can cause shelving to overturn. Improperly installed Madix shelving with offset loads can cause store fixtures to collapse. Carefully follow Madix's installation instructions in order to prevent shelving from overturning.

Additional Shelving Safety Pointers Product loading instructions are included with each Madix order. Retailers must make merchandisers aware of the product's load limitations and the dangers of overloading the shelving. Remove any merchandise or overstock before attempting to move Madix shelving. Periodically inspect your Madix shelving for damaged or loose parts. Make sure that shelves and accessories are properly seated in the slotting or perforations. Make sure that shelves and accessories are not overloaded. As merchandising changes, beware of creating offset loads on shelving runs that are not properly leveled. Look for leveling warning signs such as increased gaps between shelves or accessories that may indicate that the shelving runs need re-leveling. Damage to Madix shelving is dangerous. In some cases, the shelving should be unloaded immediately and repaired or replaced before returning to service. Re-level fixtures that you have bumped or moved. Incorporate safety into your merchandising strategy. When possible, merchandise the heavier products on the lower shelves. If the merchandise will not fit on the Madix shelves and there is a replenishment cycle, make sure that the cycle is a safe one. Make sure that merchandise and overstock are properly stacked and maintained so that items will not fall into the aisles. Assure that customers who handle merchandise or overstock will not push product from one side of the Madix fixture to the other side where people could be injured from falling merchandise. Safely secure overstock that is placed on Madix shelves overhead. Measure the difficulty that your employees have in retrieving overstock, and consider whether employees or customers could be injured if the product happens to fall from the shelving units. Teach employees and inform customers that Madix shelves should never be used as ladders to reach higher shelves. Ladders should be clearly marked for employees use only and should not be left unattended, or customers will try to remove stock on higher shelves by themselves. Notify customers to ask for assistance when they need product that is out of their reach.

POSSESSION OF THIS CATALOG IS NOT AUTHORIZATION TO SELL MADIX PRODUCTS!

ALL FACTORY QUOTES ARE GOOD FOR 30 DAYS ONLY.

Finish Policy for Metal Products

Standard Colors, Returnable– Code A Madix standard returnable colors for display shelving are Sahara, Blue Gray, Oyster, Snow White, and Satin Black. Madix standard returnable colors for wire products only are Powder Chrome and Silver Vein. All catalog items are priced in standard color.

No Charge Colors (Non-Returnable)– Code B Madix non-returnable colors offered at the standard price are Chocolate, Dove Gray, Dover White, Fashion Gray, Skyline Gray and Tru Gray. All catalog items are priced in standard color.

Optional Colors-Level I Finishes (Non-Returnable)– Code B Madix offers optional colors, also known as Grade I Finishes, at additional charge: Bright Orange, Hollyberry, Hunter Green, Mandarin, Neon Blue, Spectrum Blue, Spectrum Green, Spectrum Red and Valencia. Products painted with these colors are non-returnable.

Metal Components: \$350.00 line charge plus published per-piece charge. **Metal Back panels:** \$350.00 line charge plus published per-piece charge.

Special Colors– Code C Use line change charge plus per piece charge supplied by customer service. Special colors are non-returnable.

Pricing For Levels II To IV:

Level II: 1.6 x Optional Color Upcharge. **Example:** Optional upcharge for SUS is \$1.50; upcharge with Level II finish will be \$2.40.

Level III: 2.8 x Optional Color Upcharge. **Example:** Optional upcharge for SUS is \$1.50; upcharge with Level III finish will be \$4.20.

Level IV: 3.8 x Optional Color Upcharge. **Example:** Optional upcharge for SUS is \$1.50; upcharge with Level IV finish will be \$5.70.

Metal Components: \$500.00 line charge plus published per-piece charge. **Back panels:** \$350.00 line charge plus published per-piece charge.

Maintenance for Metal Products

Baked Enamel and Powder Coated Finishes All metal parts are finished with a specially formulated high solids or powder which are electrostatically bonded in a unique multi-stage process to insure the highest quality finish. Aerosol cans of touch-up paint are available in Madix's standard and optional colors. FAA regulations prohibit the shipment of this product by air or in export containers by air or ocean to countries outside the United States.

Product Maintenance When cleaning Madix shelving, use a non-abrasive mild detergent and warm water, followed by thorough drying. Using a soft white cotton cloth is strongly recommended. Cleaning products containing abrasives, bleach, or strong solvents will result in damage to the finish, especially when used on colors containing leafing aluminum pigment, such as powder chrome or vein-type finishes.

Finish Policy for Wood Products

High Pressure Laminate The terms "laminate" or "HPL" are commonly applied to this material which consists of multiple layers of paper infused with phenolic resin and topped by a finish paper coated with clear melamine resin, all totally bonded under high pressure and heat. The finished sheet has extremely high wear and impact resistance.

Customer Specified High Pressure Laminate Madix coding is based on Wilsonart availability. Laminates other than Wilsonart may require additional lead time.

- Customer specified laminates add \$100.00 per pattern, per order
- Additional charge will apply based on the laminate grade that is chosen

Laminates that are not from a laminate manufacturer's standard samples (metallics, heavy textures, wet looks, core edge, special prints) will require a special quote. Contact Customer Service for specific pricing on laminates not listed above.

Thermofused Panels Thermofused panels are ideal for non-wear surfaces and have substantial impact and wear characteristics compared to melamine panels previously available. The product is produced using hot press laminating polyester or melamine resin impregnated self-bonding paper to wood substrate. Performance specifications are available from the American Laminations Association. Madix does not recommend the use of Thermofused panels on horizontal or other wear surfaces.

Printed Mirror Hardboard Printed materials are primarily used for back panels, but appear as various other products. These materials are carefully cross matched to the corresponding laminates and Thermofused. Mylar mirror hardboard is used in the same applications and is also available in pegboard and grooved pegboard. **Finish Policy for Back Panels**

Standard Colors, Returnable– Code A Madix standard returnable colors for display shelving back panels are Sahara, Oyster, and Snow White.

Optional Colors-Level I Finishes (Non-Returnable)– Code B Madix non-returnable back panel colors offered at the optional price are Chocolate, Dove Gray, Dover White, Fashion Gray, Satin Black, Skyline Gray, Blue Gray and Tru Gray. Set-up charge of \$350.00 applies.

Optional Colors-Level II Finishes (Non-Brilliant)– Code B Madix offers optional back panel colors also known as non-brilliant finishes at an additional charge. These colors include custom grays, off whites, tans, and beiges not listed in Madix's Finishes brochure. Products painted with these colors are non-returnable. Set-up charge of \$350.00 applies.

Optional Colors-Level III Finishes (Brilliant)– Code C Brilliant back panel finishes include Hunter Green, Neon Blue, Spectrum Blue, and Spectrum Green. Set-up charge of \$350.00 applies.

Optional Colors-Level IV Finishes (Reds and Yellows)– Code C Use line change charge plus per piece charge supplied by customer service. Special colors are non-returnable. Set-up charge of \$350.00 applies.

Pricing For Levels II To IV

Level II 1.2 x the difference between the Hardboard/Pegboard Optional Color pricing and the Hardboard/Pegboard Sahara pricing. **Example:** Optional upcharge for a BH-342 with a Level II finish would be calculated as follows: $\$13.85 - \$12.45 = \$1.40 \times 1.2 = \1.68 . The color upcharge for a BH-342 with a Level II finish is \$1.68. This upcharge amount will be added to the Optional Color price of a BH-342. The new price of a BH-342 using a Level II finish is \$15.53 ($\$13.85 + \$1.68 = \15.53).

Level III 1.4 x the difference between the Hardboard/Pegboard Optional Color pricing and the Hardboard/Pegboard Sahara pricing. **Example:** Optional upcharge for a BH-342 with a Level III finish would be calculated as follows: $\$13.85 - \$12.45 = \$1.40 \times 1.4 = \1.96 . The new color upcharge for a BH-342 with a Level III finish is \$1.96. This upcharge amount will be added to the Optional Color price of a BH-342. The new price of a BH-342 using a Level III finish is \$15.81 ($\$13.85 + \$1.96 = \15.81).

Level IV 1.8 x the difference between the Hardboard/Pegboard Optional Color pricing and the Hardboard/Pegboard Sahara pricing. **Example:** Optional upcharge for a BH-342 with a Level IV finish would be calculated as follows: $\$13.85 - \$12.45 = \$1.40 \times 1.8 = \2.52 . The color upcharge for a BH-342 with a Level IV finish is \$2.52. This upcharge amount will be added to the Optional Color price of a BH-342. The new price of a BH-342 using a Level IV finish is \$16.37 ($\$13.85 + \$2.52 = \16.37).

NOTE! See Finishes Brochure for color samples.

Part Name	Part Number	Page Number
A		
@Front Roller Mat.....	AFRSPR4747-BLK.....	24
@Front Roller Shelf Divider with Pusher Shelf.....	AFRSWDPUSH547-6PK.....	25
@Front Roller Shelf Offset Front Stop for Pallet Rack.....	RSFSFPRWS(NW).....	25
@Front Shelf Plastic Front.....	AFRSPF(NH)(NW).....	25
@Front Shelf Plastic Front, Heavy-Duty.....	AFRSPF(NH)(NW)H.....	24
@Front Roller Shelf Wire Divider.....	AFRSWDS47.....	25
@Front Roller Shelf System for Heavy-Duty.....		24
A-Frame Trailer Coupler Angled.....	AFTCA(NL).....	40
Adjustable Tire Beam.....	Q10871-(NH)(NL)-2.....	40
Adjustable Tire Display.....	Q10871-35(NL)-2.....	49
Anchor Bolt.....	KB-TZ1/2X(LENGTH)-(QTY).....	72
Anchor Bolt.....	KB-TZ3/8X(LENGTH)-(QTY).....	72
Anchor Bolt.....	MSF-ANC.25X(LENGTH).....	73
Anchor Wedge.....	ANCWEDGE-(SIZE)(QTY)(OPT).....	72
B		
Battery Rack Retainer Wire.....	BRRW-36.....	43
C		
Center Spanner.....	SC-(NW).....	22, 42, 65
Cross Merchandise Basket.....	CMB.....	13
Cut Plywood Divider.....	OCPD-(ND).....	11
D		
Dog Food Display Deck.....	DFDD(NW)(ND)-1PB-(TYPE).....	44
Dog Food Display Front/Rear Beam.....	DFD(TYPE)-(NW)-(OPT).....	44
E		
Extension Back.....	BX(TYPE)-(NW)(NH).....	22, 42
F		
Flow Through Pallet Rack Deck.....	FTRP2D-(ND)(NL).....	7
Flow Through Wide Span Deck.....	FTWSD-(ND)(NL).....	31
G		
Gravity Feed Beam.....	HMGFB-60RD.....	43
Gravity Feed Wire Deck.....	HMGFWD-480648.....	26
Gravity Feed Wire Deck.....	HMGFWD-360860.....	43
H		
Heavy-Duty Front Beam Upper.....	HMHDFB48-U.....	46
Heavy-Duty Merchandise Hanger.....		38
Heavy-Duty Wide Span Deck Support.....	HDWSDS48.....	46
Horizontal Divider Arm, Step Beam.....	HDA-SB-(ND).....	11
Hypermaxi & Wide Span Sign Holder.....	HMSASH(NL)(NH)(OPT1)(OPT2).....	38
Hypermaxi Front Tire Beam.....	HMTB3548-2.....	38
Hypermaxi Rear Tire Beam.....	HMRTB3548-2.....	38
Hypermaxi Regular-Duty Sliding Door Kit Beam.....	HMRSDSKB(NW)-(OPT).....	51
K		
Kwik Bolt Hilti.....	KB-HUS-EZ1/4X3.....	72
L		
LEDge Light Beam Canopy Cover.....	LLBCC(CONF)(NW)-(OPT).....	51
Light-Duty Wide Span Front Beam.....	LDWFSB(NL).....	35
Lower Spanner.....	SL-(NW).....	65
M		
M Vertical Divider for Pallet Rack Box Beam.....	MVDA-(ND)(NH)(TYPE)-PR.....	10
M Vertical Divider for Pallet Rack Molding Rack Beam.....	MVDA-(ND)(NH)R-M.....	10
M Vertical Divider Single Arm.....	MVDSA-(ND).....	11
M Vertical Divider with Three Supports for Pallet Rack.....	MVDA3-3072-PR.....	10
Maxi Rack.....		53
Maxi Rack Back-to-Back Connector.....	WSBBC-2-24.....	57
Maxi Rack Beam.....	MRFB(OPT1)-(NL)(OPT2).....	54
Maxi Rack Dart Clip.....	WSDC25-50.....	55
Maxi Rack Deck.....	WSHMDRD(ND)(NL)-(TYPE).....	55
Maxi Rack Deck Support.....	(TYPE)WSDS(ND).....	55
Maxi Rack Frame.....	MRF(ND)(NH)-(OPT).....	54
Maxi Rack Frame.....	MRF2060FA.....	56
Maxi Rack Gravity Feed Beam, Light-Duty.....	MRGF48-LD.....	56
Maxi Rack Gravity Feed Retainer Wire.....	BRRW-20.....	56
Maxi Rack Gravity Feed System.....		56
Maxi Rack Gravity Feed Wire Deck.....	HMGFWDL200248.....	56
Maxi Rack Header.....	BRIH(NW).....	57
Maxi Rack Rear Product Retainer.....	HMWMSRPR48.....	57
Maxi Rack Side Product Retainer.....	WSSPR(ND).....	57
Maxi Rack Top Cap.....	WSTC-(PACK)-CL.....	54
Maxi Rack Wire Deck.....	WSHMWD-(NL)(ND)1/2X6.....	55
Maxispan.....		58
Maxispan Base Deck Beam.....	MS2BDB-(NL).....	60
Maxispan Beam.....	MS2B(NH)(NL)-2.....	59
Maxispan Deck Support.....	DSRMS-(ND)-1.....	59
Maxispan Deck Support.....	MMSDS-(ND).....	60
Maxispan Heavy-Duty Decking.....	MMSHDD-(ND).....	60
Maxispan Upright.....	MS2U(NH)-(ND).....	59
Maxispan Waterfall Wire Grid Deck.....	MSWFWGD(ND)(NL)-3.....	61
Maxispan Wire Grid Decks.....	MSWMS(ND)(NL)-3.....	61
Modified Omega Basic Upright Supports- Bracket End.....	MOUSBO-(ND)-F.....	22

Part Name	Part Number	Page Number
O		
Omega Box Beam.....	O2BB(NH)(NW).....	66
Omega Deck Frame Support.....	OFDS(ND).....	65
Omega Deck Half Bottom.....	ODHB(ND)(NL)-U.....	68
Omega Deck Regular-Duty Top.....	MODTMS(ND)(NL)-RD-U.....	67
Omega Deck Shelf.....	ODS(ND)(NL)-U.....	68
Omega Deck Shelf Bottom.....	ODSB(ND)(NL)-U.....	68
Omega Deck Shelf Support.....	OSDS(ND).....	65
Omega Display Beam.....	O2DB(OPT)(NL)HD.....	64
Omega Floating Upright Support Bracket.....	MOUSB-(ND)-F.....	64
Omega Frame.....	O2F(NH)(ND).....	64
Omega Frame Deck.....	OD(ND)(NL)-U.....	67
Omega Frame Upright.....	OFU(NH).....	64
Omega Garden Tool Front Beam.....	O2GTFB-(NW).....	71
Omega Light Mounting Kit.....	OLMK-2.....	71
Omega Merchandising System.....		62
Omega Molding Rack.....		69
Omega Molding Rack Beam Kit.....	O2FMRK(NL).....	70
Omega Molding Rack Beams.....	O2FMRB(NL)-(OPT).....	69
Omega Retainer Beam.....	O2DBF(NL)-LD.....	70
Omega Tubular Deck Support.....	MOTDSF(ND).....	65
Omega Upright.....	OU(NH).....	64
Omega Wire Grid Deck.....	OWMS(ND)(NL)-3.....	68
Omega Wood & Wire Deck.....		67
P		
Pallet & Omega Rack Deck Support.....	DSRPO-(ND)-1.....	5, 65
Pallet Rack 2" Pallet Stop Beam.....	PR2PSB(NW).....	8
Pallet Rack Back-to-Back Connector.....	PRBBC(ND).....	8, 66
Pallet Rack Basic Upright.....	PRBU-(NH).....	22, 42
Pallet Rack Basic Upright Support.....	PRBUNDS-(ND).....	22, 42
Pallet Rack Basic Upright Supports, Beam Length.....	PRBUNWS-(NL).....	22, 42
Pallet Rack Basic Upright, Flush Side.....	PRFSBU-(NH).....	22, 42
Pallet Rack Beam Cover with Sign Holder.....	PR2BCS-(NH)(NW).....	12
Pallet Rack Beam.....	PR2B(NH)(NL)-2.....	4, 26
Pallet Rack Bottom Beam.....	PR2B(NH)(NW)-2-B.....	5
Pallet Rack Center Support Arm.....	PRCSA-(NW).....	23
Pallet Rack Deck Support.....	MPRDS-(ND).....	5
Pallet Rack Deck Support.....	MPRDS-24.....	38
Pallet Rack Floor Anchor Kit.....	PRFAK-4.....	9
Pallet Rack Flush Deck Support.....	MPRDSF(ND)-2.....	5
Pallet Rack Frame.....	PR2(TYPE)F(ND)(NH).....	4, 17, 20, 25
Pallet Rack Frame Guard.....	PRUG.....	8
Pallet Rack Frame Protector.....	FP18.....	9
Pallet Rack Gravity Feed Channel.....	PR(ND)GFC(DROP)-(NW)02.....	14
Pallet Rack Heavy-Duty Cantilever End Shelf Deck.....	PR2HDFCESD(NW)(ND)(OPT).....	23
Pallet Rack Heavy-Duty Cantilever End Shelf Frame.....	PR2HDFCESFA(NW)(ND).....	23
Pallet Rack Heavy-Duty Decking.....	MPRHDD-(ND).....	6
Pallet Rack Ladder Display Assembly.....	PRLDA33.....	14
Pallet Rack Leveling Shim.....	PRSHM.....	9
Pallet Rack Loop Merchandiser.....	PR2LM-(D)-(TYPE).....	13
Pallet Rack Offset Security Doors.....		19
Pallet Rack Pallet Stop.....	PRPS-(NL).....	8, 60
Pallet Rack Pipe Bracket, Front Mount.....	PRPB-(ND)FM.....	15
Pallet Rack Pipe Bracket, Side Mount.....	PRPB-(ND).....	15
Pallet Rack Regular-Duty Deck.....	MPRRDD(ND)(NL)-(TYPE).....	5
Pallet Rack Regular-Duty Support Wire Hanger Bracket.....	MPRDSWHB-(OPT1)-(OPT2).....	38
Pallet Rack Roll Goods Display.....		23
Pallet Rack Roll Goods Tube.....	PRRGT-(NW).....	23
Pallet Rack Roll Goods Tube Holder.....	HMRGTH.....	23
Pallet Rack Security Deck.....	PRUSD-(NW)(ND).....	17
Pallet Rack Security Door Hardware Kit.....	PRSDHK-1.....	17, 20
Pallet Rack Security Door Hinge Hardware Kit.....	PRSDHHK.....	17, 20
Pallet Rack Security Doors.....	PRSD2X2-(NW)(NH)(OPT).....	17, 20
Pallet Rack Side Security Panel.....	PRSSP-(NH)(ND).....	16, 19
Pallet Rack Stop 2" OC with 3" Offset.....	PR2PS3-(NW).....	8
Pallet Rack TV Bracket.....	LCDTVCPREM(NW).....	16
Pallet Rack Upper Security Deck.....	PRUSD-(NW)(ND).....	20
Pallet Rack Upright with Security Panel.....	PRUSP-(NH).....	19
Pallet Rack Wall Mount Bracket.....	PRWMB-(ND).....	9
Pallet Rack Waterfall Wire Grid Deck.....	PRWFWGD(ND)(NL)-3.....	7
Pallet Rack Wire Grid Deck.....	PRWMS(ND)(NL)-3.....	6
Pallet Rack Wire Grid Product Retainer.....	PRWGPR-(NW)(NH).....	18
Pallet Rack Wire Grid Product Retainer 2"OC w/Ext. Bracket.....	PRWGPR2EB-(NW)(NH).....	18
Pallet Rack Wire Grid Product Retainer 2"x2".....	PRWGPR2X2-(NW)(NH).....	18
Pegboard Back.....	BP-(NW)(NH).....	66
Pegboard Back Extension.....	BXP-(NW)(NH).....	66

Part Name	Part Number	Page Number
R		
Recessed Pegboard Panel.....	RPP-(NW)(NH).....	34
Recessed Pegboard Panel Frame.....	RF-(NW)(NH).....	34
Regular-Duty Wide Span Frame.....	RDWSF3668.....	43
Regular-Duty Wide Span Front Beam with Tag Molding ...	RDWSFB(NW)-(U)-(TAG)-(UD)-(FT).....	28
Roll-Around Wide Span Unit.....	RAWSU-24(NW)60(OPT).....	39
Rug Display Clip.....	RDC-40.....	12
Rug Display for Box Beam.....	RDBB.....	12



S		
Seismic Floor Anchor Expansion Bolt.....	SFA-EB-(PACK).....	73
Seismic Floor Anchors Expansion Bolt.....	SFA-EB-1.....	25
Seismic Floor Anchor Expansion Bolt.....	SFA-EB-12-334.....	73
Splicer Spanner.....	SS-(NW).....	66
Suspended Maxi in Pallet Rack.....	21
Suspended Wide Span.....	Q1086471-(NH)(NL)-2.....	35
Suspended Maxi in Wide Span.....	41
Suspended Wide Span Frame Adapter.....	SWSFA.....	35

T		
Threaded Vertical Divider Arm.....	TVDA-(NL)(TYPE).....	36, 70
Top Spanner.....	STL-(NW).....	22, 42, 66
Top Spanner Clip.....	STLCLIP.....	22, 42
Trailer Coupler & Jack Display.....	40
Trailer Hitch Support Arm.....	THSA(NL).....	40
Trailer Hitch Support Bracket.....	THSB.....	40

V		
Vertical Divider Arm.....	VDA-(NL)(TYPE).....	11, 36, 70
Vertical Divider Arm Heavy-Duty Scan Hook.....	VDAHDSH-(NL).....	36
Vertical Divider Arm Heavy-Duty with Front Lip.....	VDA-(ND)H-FL.....	37
Vertical Divider Arm with 15° Upright, Heavy-Duty.....	VDA15DU-(NL)H.....	37
Vertical Divider Arm with 45° Hook.....	VDA-(NL)R-45.....	37
Vertical Divider Arm with with Price Tag Holder.....	VDA-(NL)R-PTH.....	36
Vertical Divider Bar.....	VDBPRB-(NW)(ND).....	11

W		
Weed Eater Holder.....	WEHPR.....	15
Wide Span.....	27
Wide Span Back-to-Back Connector.....	WSBBC-2-24.....	33
Wide Span Back-to-Back Side Mount Rug Display Bar.....	WSBBSMRD(NL)(ND).....	33
Wide Span Beam.....	(TYPE)WSFB(NL).....	28
Wide Span Bulk Merchandiser.....	45
Wide Span Center Support Arm.....	WSCSA-(ND).....	39
Wide Span Dart Clip.....	WSDC25-1.....	25
Wide Span Dart Clip.....	WSDC25-50.....	29
Wide Span Deck.....	(TYPE)WSD(ND)(NL)-U.....	29
Wide Span Deck Kit.....	RDWSK(ND)(NL)-U.....	30
Wide Span Deck Kit, Wire Grid.....	RDWSK(ND)(NL)-WG.....	30
Wide Span Deck Support.....	RDWSDS(ND).....	29
Wide Span Deck Support, Economy.....	RDWSDSE(ND).....	29
Wide Span Dog Food Display.....	RDWSDFD(ND)(NH)-REV.....	44
Wide Span End Frame Kickplate.....	WSEFKP(ND)-(COLOR).....	34
Wide Span Floor Anchor.....	WSFA-2.....	33
Wide Span Floor Anchor with Nut & Bolt.....	WS-FANB.....	33
Wide Span Frame Connector.....	WSFC-2.....	32, 45
Wide Span Frame Extension.....	WSFE-4860.....	45

Wide Span Frame.....	(TYPE)WSF(ND)(NH).....	28
Wide Span Garden Tool Display Bar.....	WSGTDB-(NL).....	13, 37
Wide Span Garden Tool Display Double Hook.....	WSGTDH-(ND).....	13, 37, 71
Wide Span Gravity Feed Battery Rack.....	43
Wide Span Gravity Feed Beam.....	HMGFB-48(TYPE).....	51
Wide Span Gravity Feed Beam.....	WSGFB-(NW)-(OPT).....	26
Wide Span Gravity Feed Channel.....	WS(FD)GFC(RISE)-(NW)02.....	50
Wide Span Gravity Feed System.....	50
Wide Span Hinged Door Kit.....	WSHDK-(NW)(NH)-(OPT1)-(OPT2)-(HAND).....	48
Wide Span Sign Holder Frame.....	WS(OPT1)SHF(NW)(NH)(OPT2).....	52
Wide Span Hypermaxi Sign Holder Modified Shelf Mount.....	WSHMSHF(NW)(NH).....	52
Wide Span, Inside-Mount, Forward-Facing Peg Hook.....	PHWSIMFF10-RD.....	38
Wide Span Leveling Shim.....	WSLS-10.....	33, 43
Wide Span Low Profile Metal Deck.....	WSLPM06(ND).....	31
Wide Span Molding Rack Beam.....	WSMR(TYPE)-(NL)(ND).....	14, 35
Wide Span Product Divider.....	WSPD-(NH)(NL).....	34
Wide Span Product Retainer.....	WSPR(NH)(NL).....	34
Wide Span, RD, Beam-Mount, Long-Handled Tool Hook.....	WSRDBMLHHTH-06.....	38
Wide Span Rear Wire Grid Security Panels.....	WSRWGSP(NW)(NH).....	48
Wide Span Retainer Pin.....	WSREP-20.....	14, 43
Wide Span Roll Goods Display.....	39
Wide Span Roll Goods Tube.....	WSRGT-(NW).....	39
Wide Span Roll Goods Tube Holder.....	HMRGTH.....	39
Wide Span Security Doors.....	47
Wide Span Security Doors.....	WSSD2X2L-(NW)(NH)(NSP).....	47
Wide Span Security Rear Panel.....	WSSRP-(NW)(NH).....	48
Wide Span Sign Holder, Adj. Ht., Top-Post-Mounted Arm.....	WSSHAHTPMA-366022.....	38
Wide Span Single Deck Display Frame.....	WSSDDF-48(NH)(OPT).....	46
Wide Span Single Deck Display Frame, Sealed.....	WSSDDFD-4848-U.....	46
Wide Span Single Hook Display.....	WSSHD-(ND).....	13, 37
Wide Span Single Hook Display.....	WSSHD-24.....	71
Wide Span Top Cap.....	WSTC-(PACK)-CL.....	29
Wide Span Upright Support Bracket Offset.....	WSUSBO-(ND).....	42
Wide Span Vertical Divider Beam.....	WSVDB(NL).....	36
Wide Span Waterfall Grid Deck.....	WSWFGD-(ND)(NL).....	32
Wide Span Wire Grid Deck, 1 x 6.....	WSWMS(ND)(NL)-16.....	32
Wide Span Wire Grid Deck.....	WSWMS(ND)(NL)-3.....	30
Wide Span Wire Grid End Security Panel.....	WSWGESP-(ND)(NH).....	47
Wire Grid Divider.....	WGVDA-(ND)(NH)-CPR.....	10





Our Purpose

Valuing people so they feel safe,
inspired, and fulfilled.





madixTM
 INNOVATION ON DISPLAY

Innovation on Display Since 1956



www.madixinc.com

Texas 500 Airport Road, Terrell, TX 75160 | 1010 S. Bolton, Jacksonville, TX 75766
Alabama 20984 Alabama Hwy. 9, Goodwater, AL 35072 | 500 Madix Drive, Eclectic, AL 36024