



madixTM
 INNOVATION ON DISPLAY

**MODULAR FITTING
 & DRESSING ROOMS**



Expose Your Shelf.

Only the best endcaps have what it takes to make an impression on your customers.

Learn more about endcap best practices at
www.madixinc.com/endcaps



Texas 500 Airport Road, Terrell, TX 75160 | 800.776.2349
Alabama 20984 Alabama Hwy 9, Goodwater, AL 35072 | 800.633.6282



Tube Line Fitting Room

Tube Line Freestanding Two Bay Fitting Room

- Fitting Rooms available in nominal heights of 96" or 108" (2438 mm or 2743 mm)
- Use Fitting Room Upright for Outside Merchandising [FRV2UOM(OPT1)(OPT2)(NH)] to merchandise the fitting room's outer walls; compatible with standard Maxi Line (two-tab) or Tube Line shelving
- ADA compliant (ADA compliant door can be made to swing in or out)

Parts Required for Two Bay Freestanding Fitting Room (shown)		
Part Number	Description	Qty.
1	FRV2P48(NH) Fitting Room Wall Panel Assembly, Nominal Width 48"	7
2	FRV2P18(NH) Fitting Room Wall Panel Assembly, Nominal Width 18"	3
3	FRV2UOM32(NH) Fitting Room Upright for Outside Merchandising	4
4	FRV2UOM42R(NH) Fitting Room Upright for Outside Merchandising	4
5	FRV2UOM43(NH) Fitting Room Upright for Outside Merchandising	2
6	FRV2U2(NH) Fitting Room Outside Upright Assembly	1
7	FRV2PD3648(NH)L Fitting Room Panel Door Assembly	2
8	FRV2WAB664818 Fitting Room Wall Alignment Brace, Nominal Length 66"	4
10*	FRV2HWP Fitting Room Hardware Pack	1

*Not shown



Tube Line Freestanding Two Bay Fitting Room consists of one standard room and one ADA room

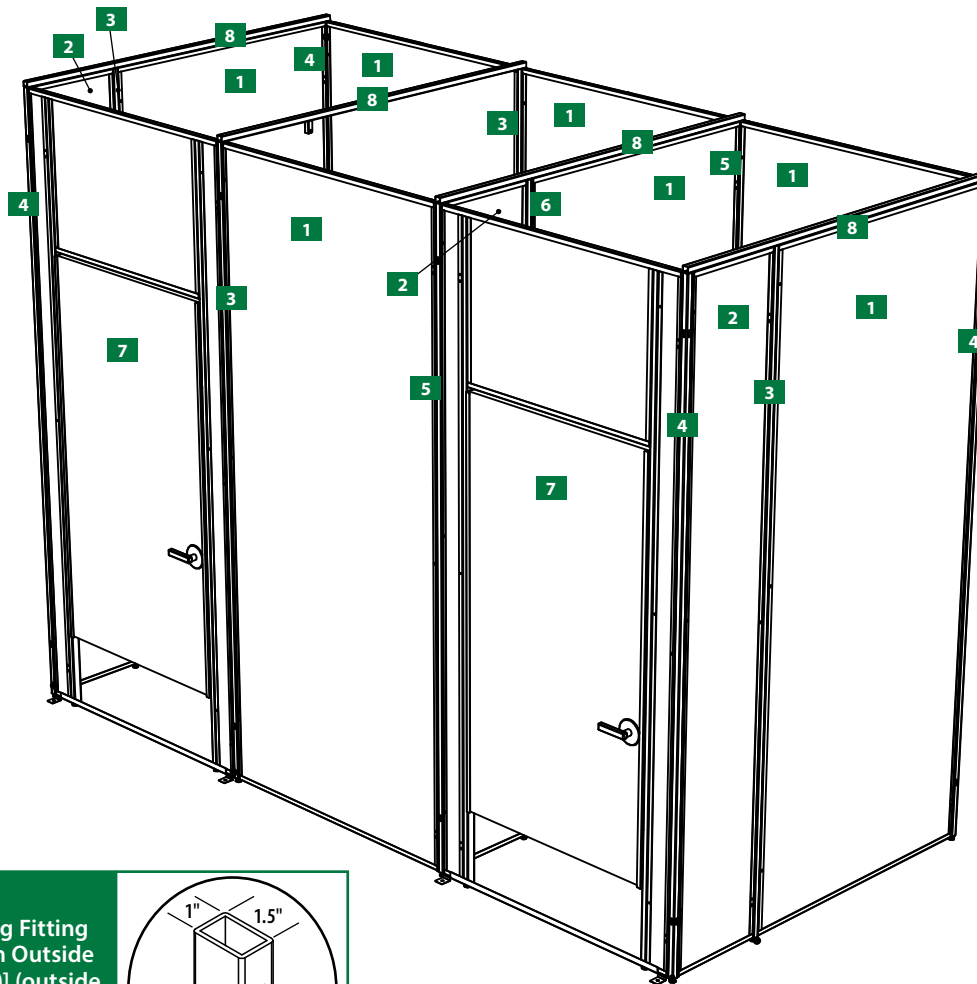

NOTE!

When using a Freestanding Fitting Room order a Fitting Room Outside Tube Mount [FRV2OTM(NH)] (outside slotted upright) as required. If not used on Freestanding Fitting Room, mounting keyslots will be visible. (See under *Optional Items.*)

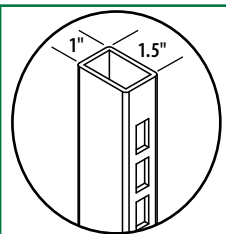

Tube Line Freestanding Three Bay Fitting Room

- Fitting Rooms available in nominal heights of 96" or 108" (2438 mm or 2743 mm)
- Use Fitting Room Upright for Outside Merchandising [FRV2UOM(OPT1)(OPT2)(NH)] to merchandise the fitting room's outer walls; compatible with standard Maxi Line (two-tab) or Tube Line shelving
- ADA compliant (ADA compliant door can be made to swing in or out)

Parts Required for Three Bay Freestanding Fitting Room (as shown)		
Part Number	Description	Qty.
1	FRV2P48(NH) Fitting Room Wall Panel Assembly, Nominal Width 48"	9
2	FRV2P18(NH) Fitting Room Wall Panel Assembly, Nominal Width 18"	4
3	FRV2UOM32(NH) Fitting Room Upright for Outside Merchandising	4
4	FRV2UOM42R(NH) Fitting Room Upright for Outside Merchandising	4
5	FRV2UOM43(NH) Fitting Room Upright for Outside Merchandising	4
6	FRV2U2(NH) Fitting Room Outside Upright Assembly	2
7	FRV2PD3648(NH)L Fitting Room Panel Door Assembly	3
8	FRV2WAB664818 Fitting Room Wall Alignment Brace, Nominal Length 66"	5
10*	FRV2HWP Fitting Room Hardware Pack	1

*Not shown



Tube Line Freestanding Three Bay Fitting Room consists of two standard rooms and one ADA room

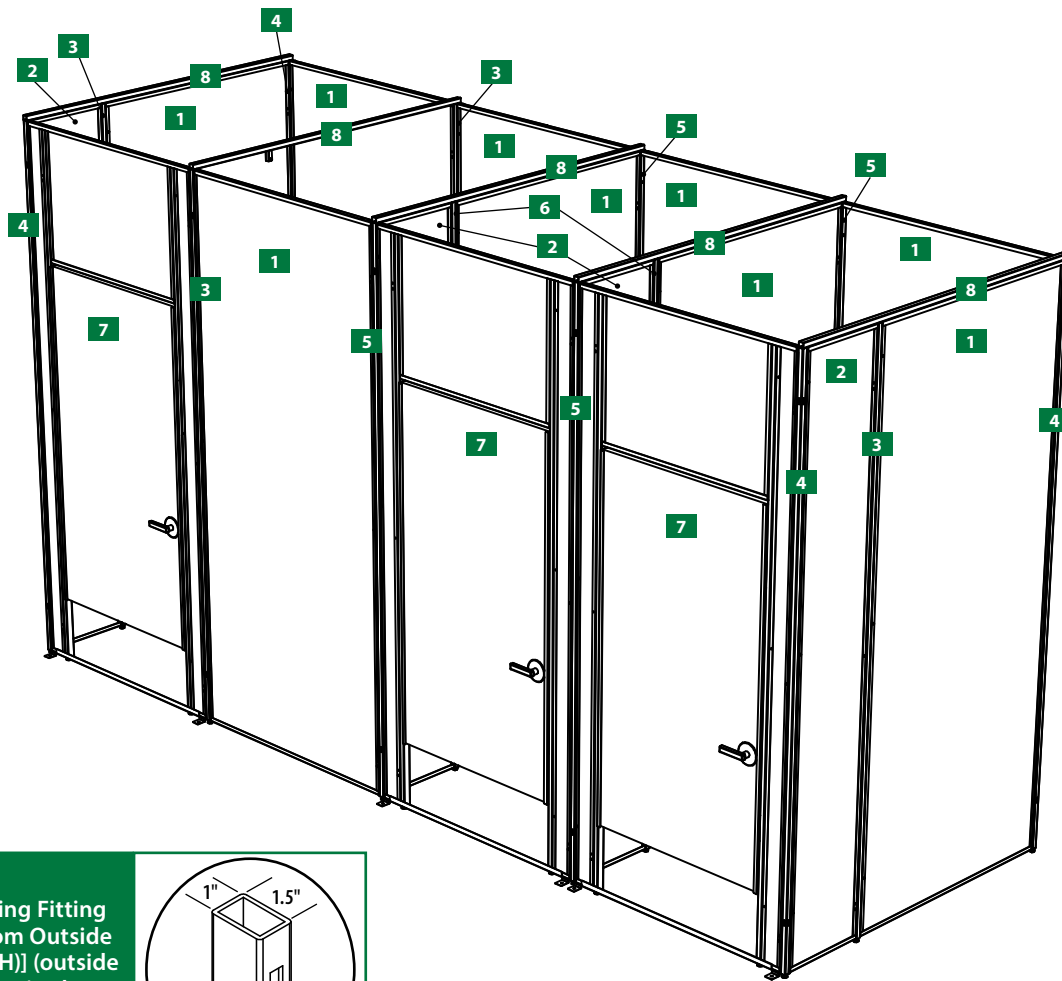

NOTE!

When using a Freestanding Fitting Room order a Fitting Room Outside Tube Mount [FRV2OTM(NH)] (outside slotted upright) as required. If not used on Freestanding Fitting Room, mounting keyslots will be visible. (See under *Optional Items.*)

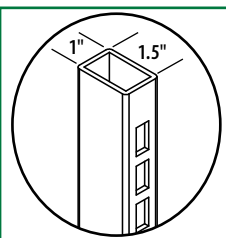

Tube Line Freestanding Standard Fitting Room – Starter

- Fitting Rooms available in nominal heights of 96" or 108" (2438 mm or 2743 mm)
- Use Fitting Room Upright for Outside Merchandising [FRV2UOM(OPT1)(OPT2)(NH)] to merchandise the fitting room's outer walls; compatible with standard Maxi Line (two-tab) or Tube Line shelving

STARTER: Standard Fitting Room (as shown)		
Part Number	Description	Qty.
1	FRV2P48(NH) Fitting Room Wall Panel Assembly, Nominal Width 48"	3
2	FRV2P18(NH) Fitting Room Wall Panel Assembly, Nominal Width 18"	2
3	FRV2UOM32(NH) Fitting Room Upright for Outside Merchandising	2
4	FRV2UOM42R(NH) Fitting Room Upright for Outside Merchandising	4
7	FRV2PD3648(NH)L Fitting Room Panel Door Assembly	1
8	FRV2WAB664818 Fitting Room Wall Alignment Brace, Nominal Length 66"	2
10*	FRV2HWP Fitting Room Hardware Pack	1

*Not shown

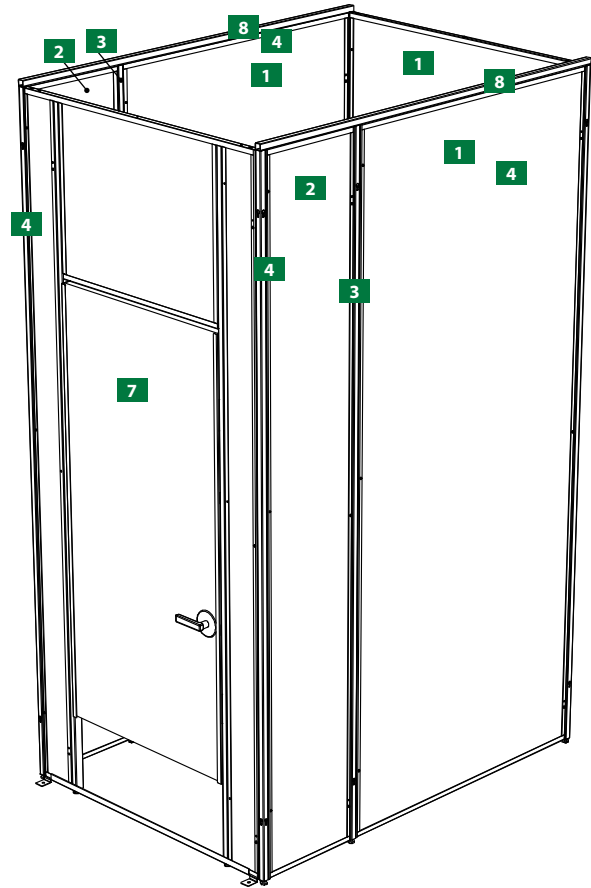

NOTE!

When using a Freestanding Fitting Room order a Fitting Room Outside Tube Mount [FRV2OTM(NH)] (outside slotted upright) as required. If not used on Freestanding Fitting Room, mounting keyslots will be visible. (See under *Optional Items.*)

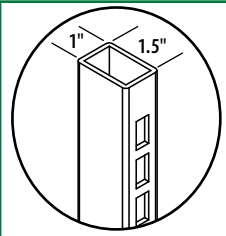

Tube Line Freestanding Standard Fitting Room – Add-On

- Fitting Rooms available in nominal heights of 96" or 108" (2438 mm or 2743 mm)
- Use Fitting Room Upright for Outside Merchandising [FRV2UOM(OPT1)(OPT2)(NH)] to merchandise the fitting room's outer walls; compatible with standard Maxi Line (two-tab) or Tube Line shelving

ADD-ON: Standard Fitting Room (as shown)		
Part Number	Description	Qty.
1	FRV2P48(NH) Fitting Room Wall Panel Assembly, Nominal Width 48"	2
2	FRV2P18(NH) Fitting Room Wall Panel Assembly, Nominal Width 18"	1
5	FRV2UOM43(NH) Fitting Room Upright for Outside Merchandising	2
6	FRV2U2(NH) Fitting Room Upright for Outside Merchandising	1
7	FRV2PD3648(NH)L Fitting Room Panel Door Assembly	1
8	FRV2WAB664818 Fitting Room Wall Alignment Brace, Nominal Length 66"	1
10*	FRV2HWP Fitting Room Hardware Pack	1

*Not shown



NOTE!

When using a Freestanding Fitting Room order a Fitting Room Outside Tube Mount [FRV2OTM(NH)] (outside slotted upright) as required. If not used on Freestanding Fitting Room, mounting keyslots will be visible. (See under *Optional Items.*)

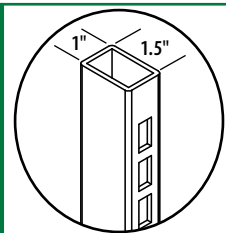

Tube Line Freestanding ADA Fitting Room – Starter

- Fitting Rooms available in nominal heights of 96" or 108" (2438 mm or 2743 mm)
- Use Fitting Room Upright for Outside Merchandising [FRV2UOM(OPT1)(OPT2)(NH)] to merchandise the fitting room's outer walls; compatible with standard Maxi Line (two-tab) or Tube Line shelving
- ADA compliant (ADA compliant door can be made to swing in or out)

STARTER: ADA Fitting Room (as shown)			
Part Number	Description		Qty.
1	FRV2P48(NH)	Fitting Room Wall Panel Assembly, Nominal Width 48"	5
2	FRV2P18(NH)	Fitting Room Wall Panel Assembly, Nominal Width 18"	2
3	FRV2UOM32(NH)	Fitting Room Upright for Outside Merchandising	4
4	FRV2UOM42R(NH)	Fitting Room Upright for Outside Merchandising	4
7	FRV2PD3648(NH)L	Fitting Room Panel Door Assembly	1
8	FRV2WAB664818	Fitting Room Wall Alignment Brace, Nominal Length 66"	3
10*	FRV2HWP	Fitting Room Hardware Pack	1

*Not shown

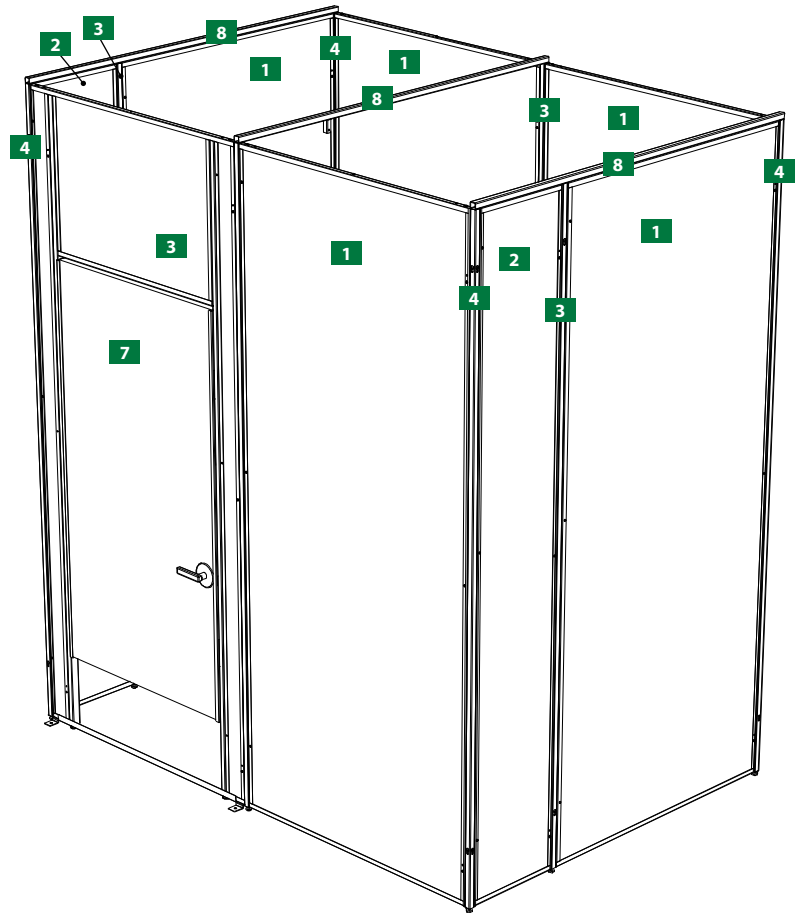

NOTE!

When using a Freestanding Fitting Room order a Fitting Room Outside Tube Mount [FRV2OTM(NH)] (outside slotted upright) as required. If not used on Freestanding Fitting Room, mounting keyslots will be visible. (See under *Optional Items.*)

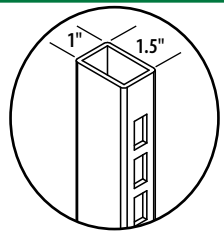

Tube Line Freestanding ADA Fitting Room – Add-On

- Fitting Rooms available in nominal heights of 96" or 108" (2438 mm or 2743 mm)
- Use Fitting Room Upright for Outside Merchandising [FRV2UOM(OPT1)(OPT2)(NH)] to merchandise the fitting room's outer walls; compatible with standard Maxi Line (two-tab) or Tube Line shelving
- ADA compliant (ADA compliant door can be made to swing in or out)

ADD-ON: ADA Fitting Room (as shown)			
Part Number	Description		Qty.
1	FRV2P48(NH)	Fitting Room Wall Panel Assembly, Nominal Width 48"	4
2	FRV2P18(NH)	Fitting Room Wall Panel Assembly, Nominal Width 18"	1
3	FRV2UOM32(NH)	Fitting Room Upright for Outside Merchandising	2
5	FRV2UOM43(NH)	Fitting Room Upright for Outside Merchandising	2
6	FRV2U2(NH)	Fitting Room Upright for Outside Merchandising	1
7	FRV2PD3648(NH)L	Fitting Room Panel Door Assembly	1
8	FRV2WAB664818	Fitting Room Wall Alignment Brace, Nominal Length 66"	2
10*	FRV2HWP	Fitting Room Hardware Pack	1

*Not shown

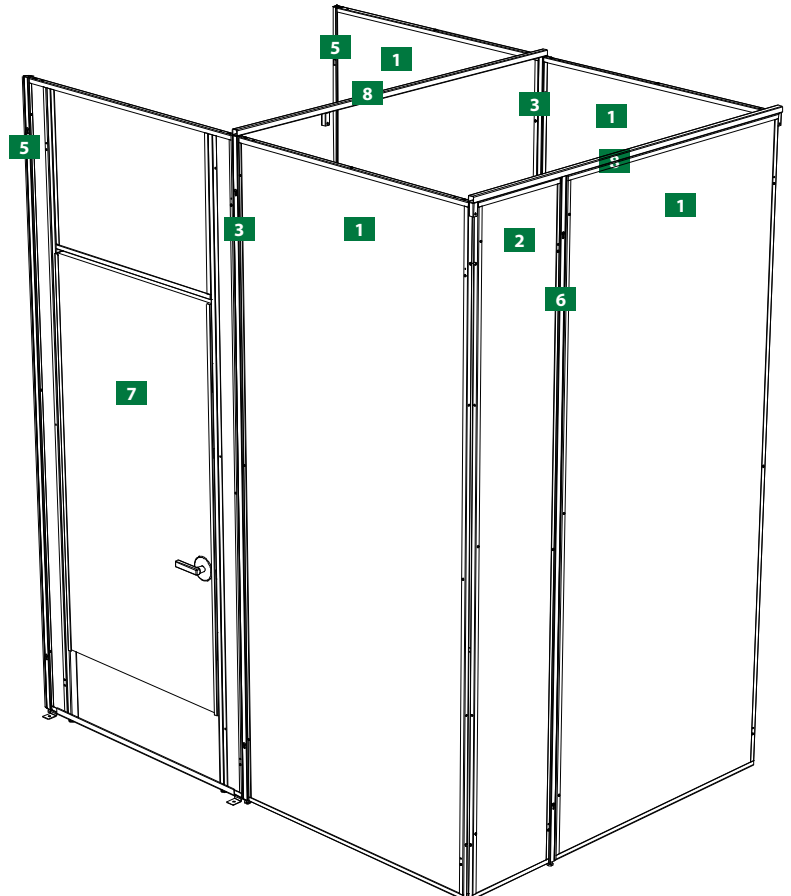

NOTE!

When using a Freestanding Fitting Room order a Fitting Room Outside Tube Mount [FRV2OTM(NH)] (outside slotted upright) as required. If not used on Freestanding Fitting Room, mounting keyslots will be visible. (See under *Optional Items.*)

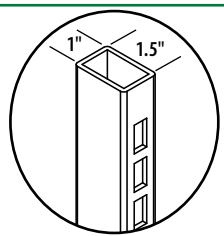

1 2 Fitting Room Wall Panel Assembly

FRV2P(NW)(NH)

FRV2 Fitting Room
 P Panel
 NW Nominal Width 18" or 48"
 (457 mm or 1219 mm)
 NH Nominal Height 96" or 108"
 (2438 mm or 2743 mm)

Finish Code

FIN1-FIN2

FIN1 Paint
 FIN2 Laminate

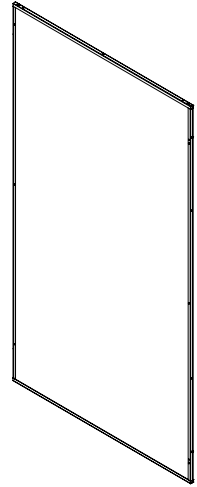

3 4 5 Fitting Room Upright for Outside Merchandising

- Keyslot feature allows use of Fitting Room Outside Tube Mount FRV2OTM(NH) slotted uprights for outside merchandising
- Connects wall panels together utilizing keyslot feature
- Welded side angles ensure occupant privacy while providing a secure wall-to-wall connection
- Pre-installed leveling leg allows for easy height adjustment for unlevel floors up to 1½" (38 mm)

FRV2UOM(OPT1)(OPT2)(NH)

FRV2 Fitting Room
 UOM Upright Outside Merchandising
 OPT1 Sides Slotted 3 or 4
 OPT2 Channel Configuration 2R, 2 or 3
 NH Nominal Height 96" or 108"
 (2438 mm or 2743 mm)

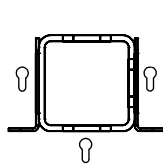

3 FRV2UOM32(NH)

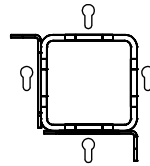

4 FRV2UOM42R(NH)

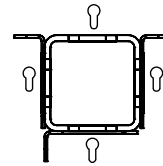

5 FRV2UOM43(NH)

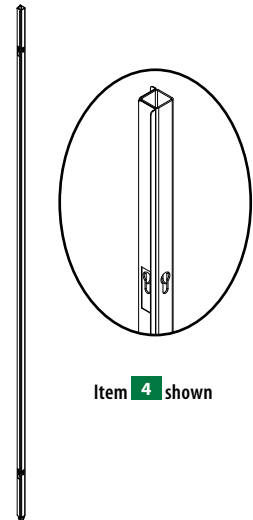

Item 4 shown

6 Fitting Room Outside Upright Assembly

- Connects wall panels together utilizing keyslot feature
- Welded side angles ensure occupant privacy while providing a secure wall-to-wall connection
- Pre-installed leveling leg allows for easy height adjustment for unlevel floors up to 1½" (38 mm)

FRV2U2(NH)

FRV2 Fitting Room
 U Upright Assembly
 2 Sides Slotted 2
 NH Nominal Height 96" or 108"
 (2438 mm or 2743 mm)

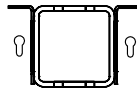

6 FRV2U2(NH)

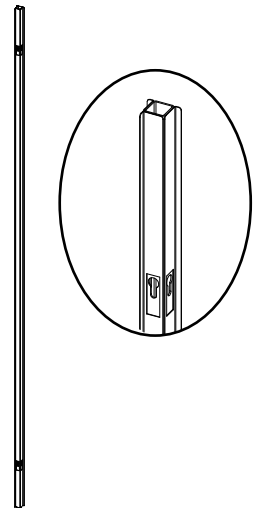

NOTE!

When using a Freestanding Fitting Room order a Fitting Room Outside Tube Mount [FRV2OTM(NH)] (outside slotted upright) as required. If not used on Freestanding Fitting Room, mounting keyslots will be visible. (See under *Optional Items.*)

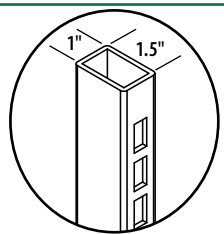

7 Fitting Room Panel Door Assembly

- Door with locking handle
- Left-hand swing door must be used when ordering handicapped (ADA) dressing rooms

FRV2PD3648(NH)(HAND)

FRV2 Fitting Room
 PD Panel Door Assembly
 36 Door Width 36" (914 mm)
 48 Nominal Width 48" (1219 mm)
 NH Nominal Height 96" or 108"
 (2438 mm or 2743 mm)
 HAND L=Left Hand
 R=Right Hand

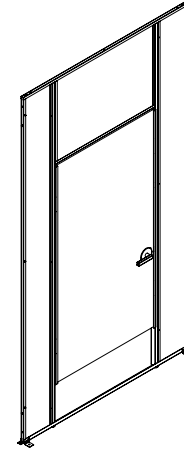

8 Fitting Room Wall Alignment Brace

FRV2WAB664818

FRV2 Fitting Room
 WAB Wall Alignment Brace
 66 Nominal Length 66" (1676 mm)
 48 Nominal Width One 48" (1219 mm)
 18 Nominal Width Two 18" (457 mm)

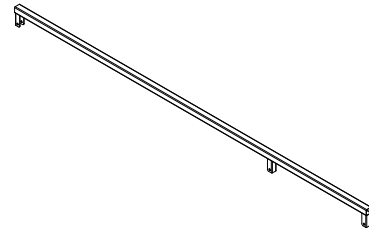

10 Fitting Room Hardware Pack

- Hardware pack contains:
 - Fitting Room Corner Anchor
 - Anchor Bolt 1/4 x 2
 - Fitting Room Panel Installer
 - Leveler Wrench

FRV2HWP

FRV2 Fitting Room
 HWP Hardware Pack

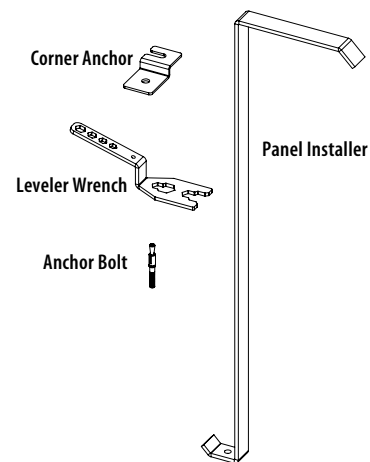

Fitting Room Outside Tube Mount

- Merchandise the outside of the rooms with standard Maxi Line (two-tab) or Tube Line shelving components
- Uprights attach to posts utilizing keyslot feature for quick installation
- Upright slots will be visible
- Cannot be used on wall-mount version

FRV2OTM(NH)

FRV2 Fitting Room
 OTM Outside Tube Mount
 NH Nominal Height 96" or 108"
 (2438 mm or 2743 mm)

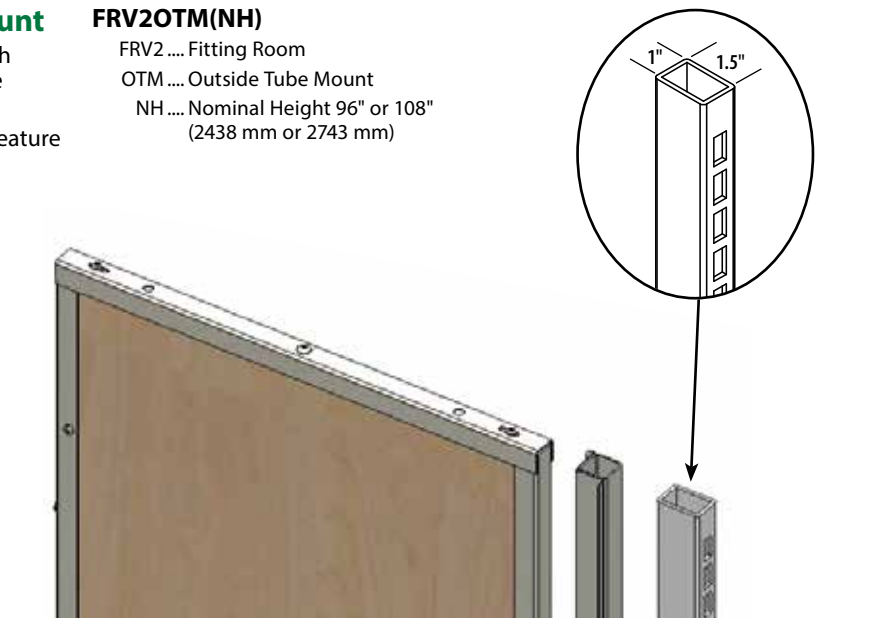

Tube Line Wall Mount Two Bay Fitting Room

- Fitting Rooms available in nominal heights of 96" or 108" (2438 mm or 2743 mm)
- Mounts to an existing wall
- ADA compliant (ADA compliant door can be made to swing in or out)

Parts Required for Two Bay Wall Mount Fitting Room (as shown)		
Part Number	Description	Qty.
1	FRV2P48(NH) Fitting Room Wall Panel Assembly, Nominal Width 48"	1
2	FRV2P60(NH) Fitting Room Wall Panel Assembly, Nominal Width 60"	3
3	FRV2U2C(NH) Fitting Room Outside Upright Assembly	2
4	FRV2U3(NH) Fitting Room Outside Upright Assembly	1
6	FRV2U2(NH) Fitting Room Outside Upright Assembly	1
7	FRV2PD3648(NH)L Fitting Room Panel Door Assembly	2
10*	FRV2HWP Fitting Room Hardware Pack	1
11	FRV2U(NH)WA Fitting Room Wall Mount Upright Post	3
12	FRV2WMB60 Fitting Room ADA Wall Mount Brace, Nominal Length 60"	1

*Not shown



Tube Line Wall Mount Two Bay Fitting Room consists of one standard room and one ADA room

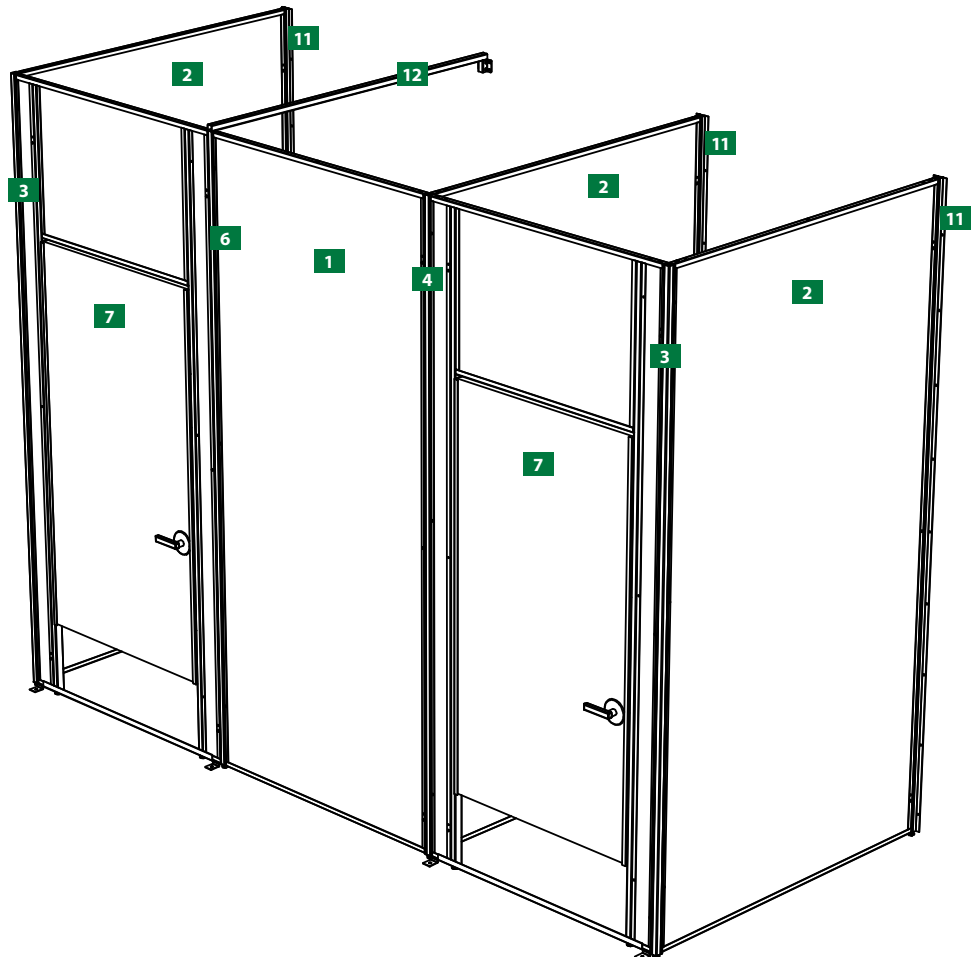

NOTE!

Fitting Room Outside Tube Mount [FRV2OTM(NH)] **CANNOT** be installed on Wall Mount Fitting Rooms; therefore, these cannot be merchandised.

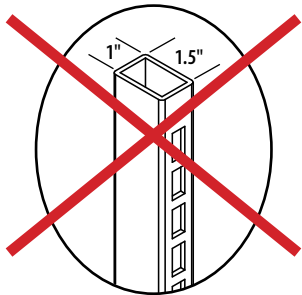

DO NOT USE ON WALL MOUNT FITTING ROOM!

Tube Line Standard Wall Mount Fitting Room – Starter

- Fitting Rooms available in nominal heights of 96" or 108" (2438 mm or 2743 mm)
- Mounts to an existing wall

STANDARD STARTER: Wall Mounted Fitting Room		
Part Number	Description	Qty.
2	FRV2P60(NH) Fitting Room Wall Panel Assembly, Nominal Width 60"	2
3	FRV2U2C(NH) Fitting Room Upright Outside Assembly	2
7	FRV2PD3648(NH)L Fitting Room Panel Door Assembly	1
10*	FRV2HWP Fitting Room Hardware Pack	1
11	FRV2U(NH)WA Fitting Room Wall Mount Upright Post	2

*Not shown

NOTE!
Wall Mount Fitting Rooms
CANNOT be merchandised!

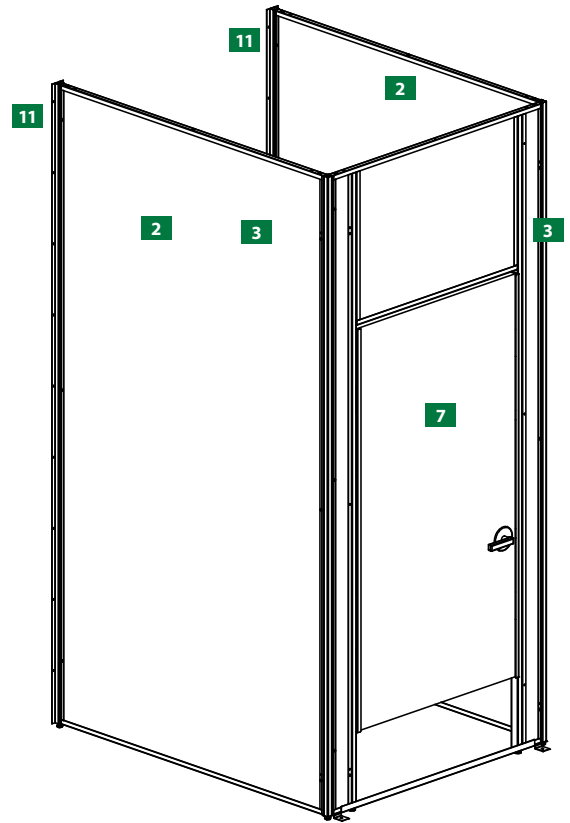

Tube Line Standard Wall Mount Fitting Room – Add-On

- Fitting Rooms available in nominal heights of 96" or 108" (2438 mm or 2743 mm)
- Mounts to an existing wall

STANDARD ADD-ON: Wall Mounted Fitting Room		
Part Number	Description	Qty.
2	FRV2P60(NH) Fitting Room Wall Panel Assembly, Nominal Width 60"	1
4	FRV2U3(NH) Fitting Room Upright Outside Assembly	1
7	FRV2PD3648(NH)L Fitting Room Panel Door Assembly	1
10*	FRV2HWP Fitting Room Hardware Pack	1
11	FRV2U(NH)WA Fitting Room Wall Mount Upright Post	1

*Not shown

NOTE!
Wall Mount Fitting Rooms
CANNOT be merchandised!

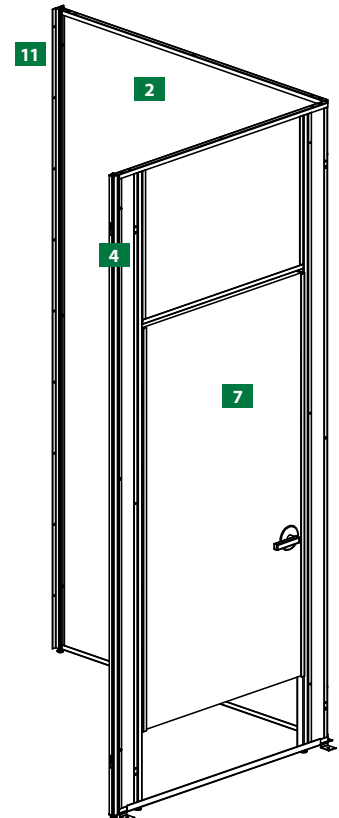

Tube Line ADA Standard Wall Mount Fitting Room – Starter

- Fitting Rooms available in nominal heights of 96" or 108" (2438 mm or 2743 mm)
- Mounts to an existing wall
- ADA compliant (ADA compliant door can be made to swing in or out)

ADA STARTER: Wall Mounted Fitting Room		
Part Number	Description	Qty.
1	FRV2P48(NH) Fitting Room Wall Panel Assembly, Nominal Width 48"	1
2	FRV2P60(NH) Fitting Room Wall Panel Assembly, Nominal Width 60"	2
3	FRV2U2C(NH) Fitting Room Upright Outside Assembly	2
6	FRV2U2(NH) Fitting Room Upright Outside Assembly	1
7	FRV2PD3648(NH)L Fitting Room Panel Door Assembly	1
10*	FRV2HWP Fitting Room Hardware Pack	1
11	FRV2U(NH)WA Fitting Room Wall Mount Upright Post	2
12	FRV2WMB60 Fitting Room ADA Room Wall Mount Brace	1

*Not shown

NOTE!
Wall Mount Fitting Rooms **CANNOT** be merchandised!

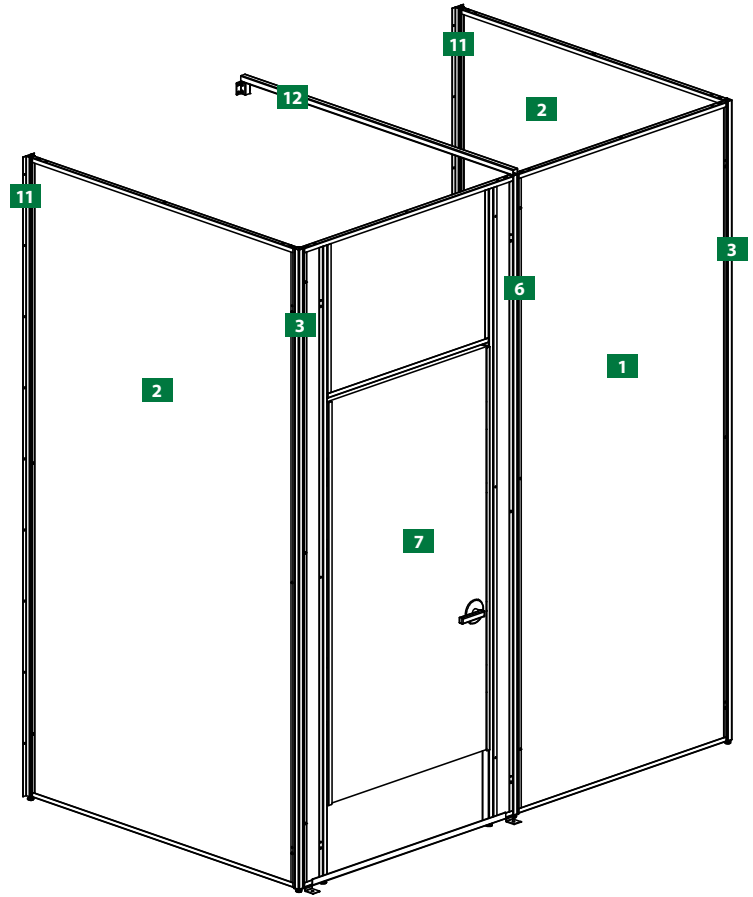

Tube Line ADA Standard Wall Mount Fitting Room – Add-On

- Fitting Rooms available in nominal heights of 96" or 108" (2438 mm or 2743 mm)
- Mounts to an existing wall
- ADA compliant (ADA compliant door can be made to swing in or out)

ADA STARTER: Wall Mounted Fitting Room		
Part Number	Description	Qty.
1	FRV2P48(NH) Fitting Room Wall Panel Assembly, Nominal Width 48"	1
2	FRV2P60(NH) Fitting Room Wall Panel Assembly, Nominal Width 60"	1
4	FRV2U3(NH) Fitting Room Upright Outside Assembly	1
6	FRV2U2(NH) Fitting Room Upright Outside Assembly	1
7	FRV2PD3648(NH)L Fitting Room Panel Door Assembly	1
10*	FRV2HWP Fitting Room Hardware Pack	1
11	FRV2U(NH)WA Fitting Room Wall Mount Upright Post	1
12	FRV2WMB60 Fitting Room ADA Room Wall Mount Brace	1

*Not shown

NOTE!
Wall Mount Fitting Rooms **CANNOT** be merchandised!

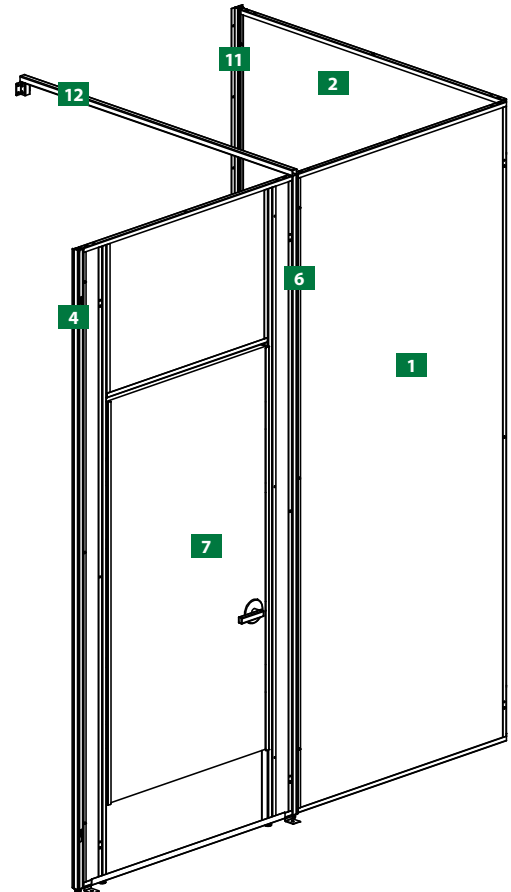

1 2 Fitting Room Wall Panel Assembly

FRV2P(NW)(NH)

FRV2 Fitting Room
 P Panel
 NW Nominal Width 48" or 60"
 (1219 mm or 1524 mm)
 NH Nominal Height 96" or 108"
 (2438 mm or 2743 mm)

Finish Code

FIN1-FIN2

FIN1 Paint
 FIN2 Laminate

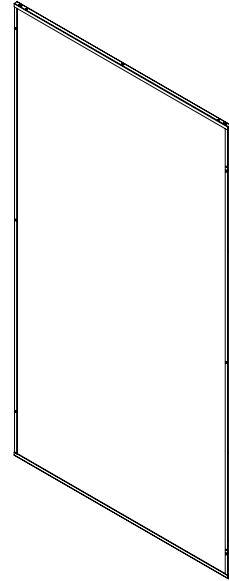

3 4 6 Fitting Room Outside Upright Assembly

- Keyslot feature allows use of Fitting Room Outside Tube Mount FRV2OTM(NH) slotted uprights for outside merchandising
- Connects wall panels together utilizing keyslot feature
- Welded side angles ensure occupant privacy while providing a secure wall-to-wall connection
- Pre-installed leveling leg allows for easy height adjustment for unlevel floors up to 1½" (38 mm)

FRV2U(OPT)(NH)

FRV2 Fitting Room
 U Upright Assembly
 OPT Sides Slotted 2, 2C2 or 3
 NH Nominal Height 96" or 108"
 (2438 mm or 2743 mm)

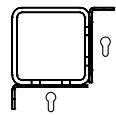

3 FRV2U2C(NH)

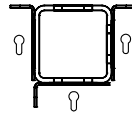

4 FRV2U3(NH)

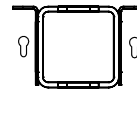

6 FRV2U2(NH)

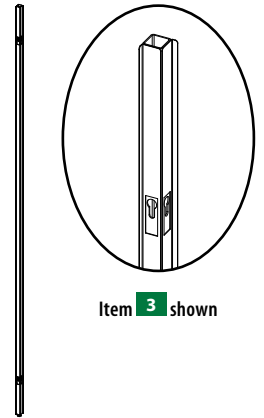

7 Fitting Room Panel Door Assembly

- Door with locking handle
- Left-hand swing door must be used when ordering handicapped (ADA) dressing rooms

FRV2PD3648(NH)(HAND)

FRV2 Fitting Room
 PD Panel Door Assembly
 36 Door Width 36" (914 mm)
 48 Nominal Width 48" (1219 mm)
 NH Nominal Height 96" or 108"
 (2438 mm or 2743 mm)
 HAND L=Left Hand
 R=Right Hand

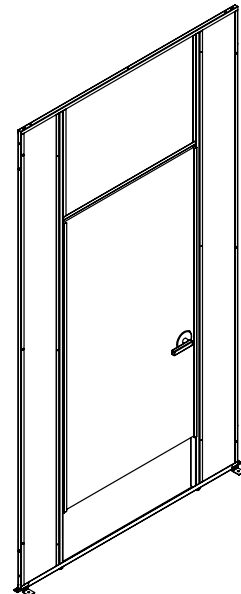

10 Fitting Room Hardware Pack

- Hardware pack contains:
 - Fitting Room Corner Anchor
 - Anchor Bolt 1/4 x 2
 - Fitting Room Panel Installer
 - Leveler Wrench

FRV2HWP

FRV2 Fitting Room
HWP Hardware Pack

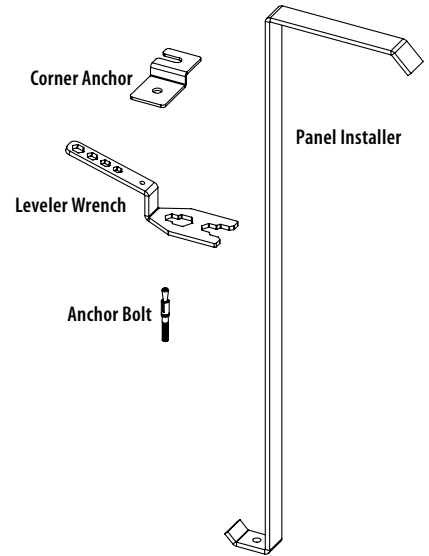

11 Fitting Room Upright Wall Attachment

FRV2U1(NH)WA

FRV2 Fitting Room
U1 Upright, Slotted One Side
NH Nominal Height 96" or 108"
(2438 mm or 2743 mm)
WA Wall Attachment

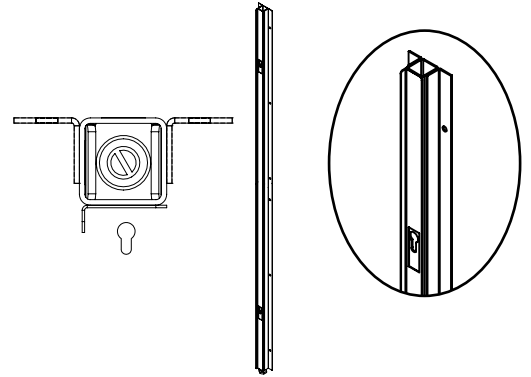

12 Fitting Room Wall Mount Brace, 60"

- Hardware included

FRV2WMB60

FRV2 Fitting Room
WMB Wall Mount Brace
60 Nominal Length 60" (1524 mm)

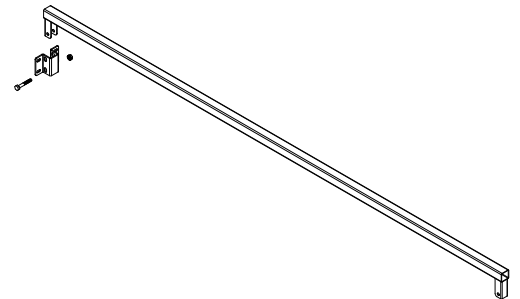

Optional Items

Fitting Room Grab Rail, 36"

- ADA Grab Rail
- 36" (914 mm) nominal length

FRV2GR

FRV2 Fitting Room
GR Grab Rail

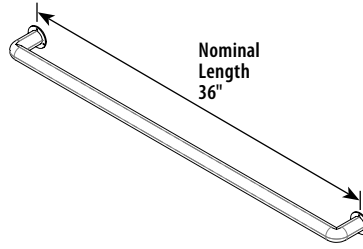

Fitting Room Clothes Hanger

- Used in fitting room interior to hang apparel

FRV2CH

FRV2 Fitting Room
CH Clothes Hanger

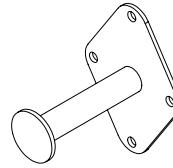

Fitting Room Standard Room Corner Bench

- Standard fitting-room seating

FRV2SRCB-19NP

FRV2 Fitting Room
SRCB Standard Room Corner Bench
19 Nominal Height 19" (483 mm)
NP NP=No Perforations

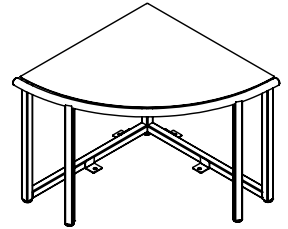

Fitting Room ADA Bench Modified

- Standard fitting-room seating

FRV2HRBM-(NW)(19)(ND)

FRV2 Fitting Room
HRBM ADA Bench Modified
NW Nominal Width 36" or 48"
(914 mm or 1219 mm)
19 Nominal Height 19" (483 mm)
ND Nominal Depth 16" or 24"
(406 mm or 610 mm)

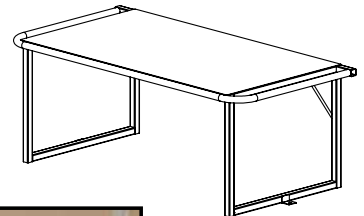

Fitting Room Metal Framed Mirror

- Flat-mount mirrors
- 55 $\frac{7}{16}$ "H x 19 $\frac{1}{4}$ "W (1408 mm x 489 mm)

FRMFM

- FR.... Fitting Room
- MFM.... Metal Framed Mirror

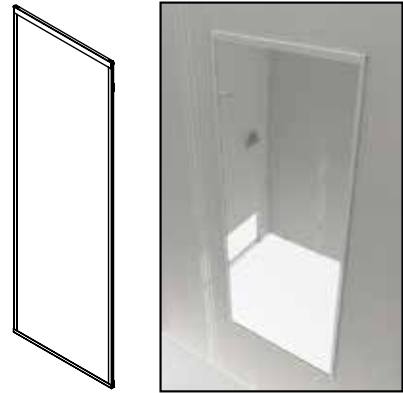

Fitting Room Metal Framed Mirror

- Flat-mount mirrors
- 55 $\frac{7}{16}$ "H x 22 $\frac{1}{2}$ "W (1408 mm x 489 mm)
- Meets ADA regulations

FRMFM54225

- FR.... Fitting Room
- MFM.... Metal Framed Mirror
- 54.... Nominal Height 54" (1372 mm)
- 225.... Nominal Width 22.5" (572 mm)

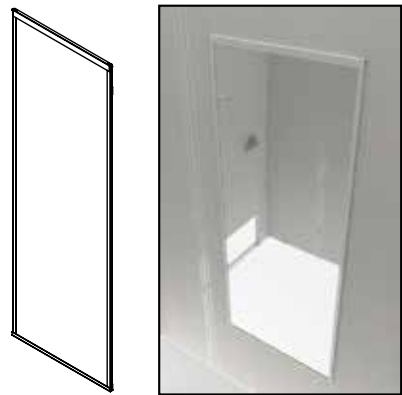

For more fitting-room merchandising accessories, visit www.madixinc.com



Maxi Line Dressing Room

Maxi Line Dressing Room

- Flexible size configurations
- Use outside walls to display merchandise on standard Maxi Line shelving
- Can be reconfigured using standard back sizes
- Door is customer supplied or a door with lock can be ordered

NOTE!
Cannot be attached to an existing wall, cement block, sheetrock, etc.



Parts Required for Single Dressing Room (shown)			
Part Number	Description	Qty.	
A	BU-96	Basic Upright	10
B	EU-24	Extension Upright	10
C	SL-4	Lower Spanner 4'	4
D	SL-5	Lower Spanner 5'	1
E	SS-4	Splicer Spanner 4'	12
F	SS-5	Splicer Spanner 5'	3
G	STL-4	Top Spanner 4'	6
H	STL-5	Top Spanner 5'	6
I	OBS-4	Open Back Stiffener 4'	4
J	OBS-5	Open Back Stiffener 5'	1
K	OBSKP-48	Open Back Kickplate 4'	4
L	OBSKP-60	Open Back Kickplate 5'	1
M	BH-436	Hardboard Back 48" x 36"	4
N	BH-536	Hardboard Back 60" x 36"	1
O	BXH-430	Hardboard Back Extension 48" x 36"	8
P	BXH-530	Hardboard Back Extension 60" x 36"	2
Q	BXHL-424	Hardboard Back Extension Laminate 48" x 36"	8
R	BXHL-524	Hardboard Back Extension Laminate 60" x 36"	2
S	MEBP-4836	Metal Extension Pegboard 48" x 36"	4
T	MEBP-6036	Metal Extension Pegboard 60" x 36"	1
U	MEBP-4830	Metal Extension Pegboard 48" x 30"	8
V	MEBP-6030	Metal Extension Pegboard 60" x 30"	2
W	TLEGSILSL(ND)	T-Leg,HD, Straight-In Locking	6
W1	TLUCP	TL Cap for T-Leg	6
X	DRTRS	Dressing Room Top Rail Stabilizer	2
Y	DRUFC	Dressing Room Upright Face Cover 120"	2
Z	DRICF	Dressing Room Inside Corner Filler 120"	4
AA	DROCF	Dressing Room Outside Corner Filler 120"	4
BB	DRUS	Dressing Room Upright Spacer	4
CC	DRIA	Dressing Room Inside Anchor	2
DD	DROA	Dressing Room Outside Anchor	2
EE	SFA-RD-1	Seismic Floor Anchors	6
FF	SFA-EB-1	Seismic Floor Anchors Expansion Bolts	12
GG	DRDP-60	Dressing Room Door Panel	1
HH	DPS	Dressing Panel Splicer	1
II	DRDPR-LH	Dressing Room Door Panel Retainer-Left Hand	1
JJ	DRDPR-RH	Dressing Room Door Panel Retainer-Right Hand	1
KK	DRDPS	Dressing Room Divider Panel Stabilizer	2
LL	DR88HP	Dressing Room Hardware Pack	1

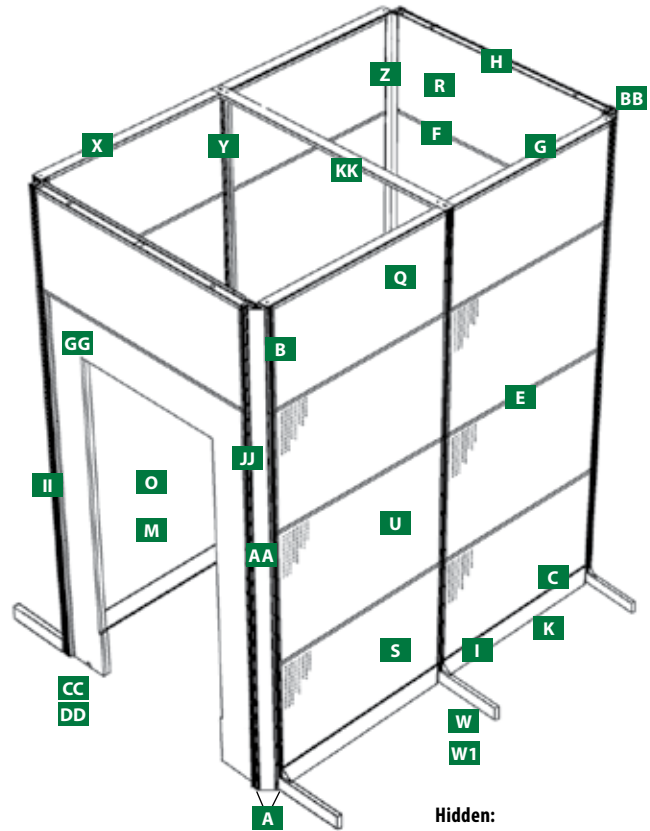

NOTE!
Dressing Room Door Panel with Locking Door (DRDPWLD60) can be used in place of Dressing Room Door Panel (DRDP-60).

- Hidden:**
- D SL-5
 - J OBS-5
 - L OBSKP-60
 - N BH-536
 - P BXH-530
 - T MEBP-6036
 - V MEBP-6030
 - EE SFA-RD-1
 - FF SFA-EB-1
 - HH DPS
 - LL DR88HP

A Basic Upright

- Slotted 1" (25 mm) OC for flexibility plus maximum space
- Comprised of heavy-gauge, high-tensile steel components welded into a single unit with a 15,000 inch-pound rating
- All Basic Uprights have an integrated leveler
- Kickplates of either closed or open type (or reinforced base shoes) must be installed on shelving runs

BU-(NH)

- BU Basic Upright
 NH Nominal Height 36" to 144" in 6" increments
 (914 mm to 3658 mm in 152 mm increments)

**B Extension Upright**

- Connector inserts easily into top of shelving section upright
- Set screws expand the connector, solidly aligning assembly

EU-(NH)

- EU Extension Upright
 NH Nominal Height 6" to 54" in 6" increments
 (152 mm to 1371 mm in 152 mm increments)

Nominal Height	Maximum Load Capacity
06"-18"	200 lbs per side
19"-54"	100 lbs per side

**C D Lower Spanner**

- Snap-in spanner secures uprights at equal spacing and supports back panels
- Electrical knockouts

SL-(NW)

- SL Lower Spanner
 NW Nominal Width 4' or 5'
 (1219 mm or 1524 mm)

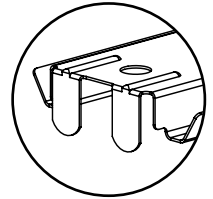
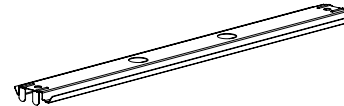
**E F Splicer Spanner**

- Splicer spanner joins two back panels in sections 78" (1981 mm) and above
- Electrical knockouts

SS-(NW)

- SS Splicer Spanner
 NW Nominal Width 4' or 5'
 (1219 mm or 1524 mm)

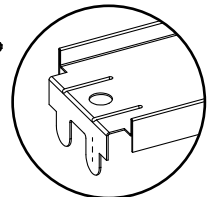
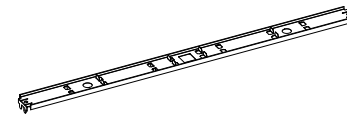
**G H Top Spanner**

- Snap-in spanner secures uprights at equal spacing, holds back panels, and trims top of section
- Electrical knockouts

STL-(NW)

- STL Top Spanner
 NW Nominal Width 4' or 5'
 (1219 mm or 1524 mm)

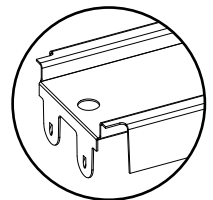
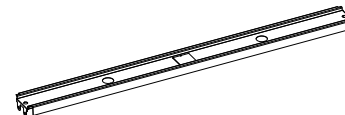
**I J Open Back Stiffener**

- Electrical knockouts
- Bolts in place to add stability

OBS-(NW)

- OBS Open Back Stiffener
 NW Nominal Width 4' or 5'
 (1219 mm or 1524 mm)

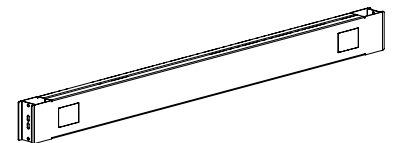
**K L Open Back Stiffener Kickplate****OBSKP-(NW)**

- OBSKP Open Back Stiffener Kickplate
 NW Nominal Width 24", 30", 36", 48" or 60"
 (610 mm, 762 mm, 914 mm, 1219 mm or 1524 mm)

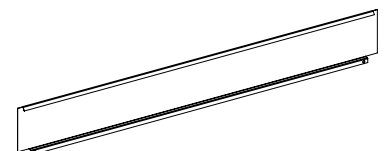

M N Back Panel

- Hardboard or pegboard available

B(TYPE)-(NW)(NH)

B Back
 TYPE P=Pegboard
 H=Hardboard
 NW Nominal Width 4' or 5'
 (1219 mm or 1524 mm)
 NH Nominal Height 36" to 72" in 6" increments
 (914 mm to 1829 mm in 152 mm increments)

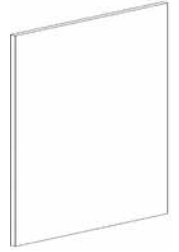

O P Q R Back, Extension

- Hardboard or pegboard available

BX(TYPE)-(NW)(NH)

BX Back Extension
 TYPE P=Pegboard
 H=Hardboard
 NW Nominal Width 4' or 5'
 (1219 mm or 1524 mm)
 NH Nominal Height 36" to 72" in 6" increments
 (914 mm to 1829 mm in 152 mm increments)



Metal Back Panels

- Heavy-gauge metal panel
- Coined perforations 1" OC (25 mm)
- Durable

NOTE!
 Requires the use of
 Slatwall Spanners, SC-(NW).

Non-Perforated MBP-(NW)(NH)-NP

MBP Metal Back Panel
 NW Nominal Width 36" or 48"
 (914 mm or 1219 mm)
 NH Nominal Height 36" to 72"
 in 6" increments
 (914 mm to 1829 mm
 in 152 mm increments)
 NP Non-perforated

Perforated MBP-(NW)(NH)

MBP Metal Back Panel
 NW Nominal Width 36" or 48"
 (914 mm or 1219 mm)
 NH Nominal Height 36" to 72"
 in 6" increments
 (914 mm to 1829 mm
 in 152 mm increments)

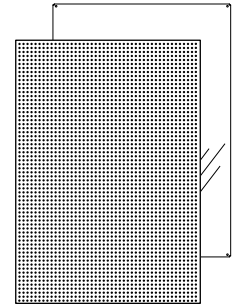

S T U V Metal Extension Back Panels

- Use above the lower panels in Maxi Line sections 78" (1981 mm) tall or taller

MEBP-(NW)(NH)-(OPT)

MEBP Metal Extension Back Panel
 NW Nominal Width 36" or 48"
 (914 mm or 1219 mm)
 NH Nominal Height 36", 42", 48", 54"
 (914 mm, 1067 mm, 1219 mm, 1372 mm)
 OPT NP=Non-perforated, Blank=Perforated

W T-Leg Straight-In Locking, Spring Loaded

- Does not require hardware to attach to the Basic Upright [BU-(NH)]
- Installs straight into the Madix upright
- Legs can be removed and changed to another depth without disassembling the gondola
- Only use leveler option for Changing Rooms
- Load capacity is 500 lbs per section for Ball Bearing Caster
- Load capacity without a caster is 9000 in-lb

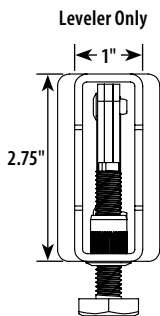

W1 TL Cap for T-Leg

- Black plastic only
- Ordered separately

TLUCP

TLUCP TL Upright Cap (Black only)

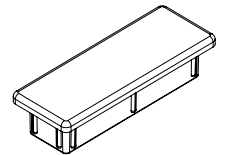

TLEGSILSL(ND)-(OPT)

TLEG T-Leg
 SIL Straight-In Locking
 SL Spring Loaded
 ND Nominal Depth 10" to 24" in 2" increments
 (254 mm to 610 mm in 51 mm increments)
 OPT Blank=Leveler Only
 BBC=Ball Bearing Caster

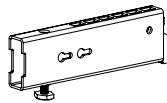

NOTE!
 Please contact Sales Representative
 if loads exceed the
 recommended capacities.

X Dressing Room Top Rail Stabilizer

- Connects tops of outside wall sections

DRTRS

DRTRS Dressing Room Top Rail Stabilizer

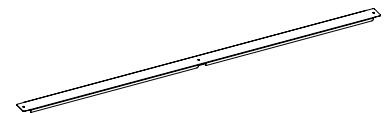

Dressing Room Corner Crossbar

- Connects interior wall between dressing rooms
- Required for double dressing rooms

DRCCB

DRCCB Dressing Room Corner Crossbar

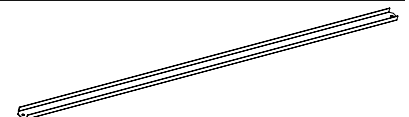

Y Dressing Room Upright Face Cover

- Covers slots to block line of sight when upright is exposed on wall section

DRUFC-(NH)

DRUFC Dressing Room Upright Face Cover
 NH Nominal Height 96", 102", 108", 112"
 (2438 mm, 2591 mm, 2743 mm or 2845 mm)
 Blank=Standard 120" (3048 mm)



Z Dressing Room Inside Corner Filler

- Covers slots to prevent line of sight in each corner
- One for each inside corner

DRICF-(NH)

DRICF Dressing Room Inside Corner Filler
 NH Nominal Height 96", 102", 108", 112"
 (2438 mm, 2591 mm, 2743 mm or 2845 mm)
 Blank=Standard 120" (3048 mm)

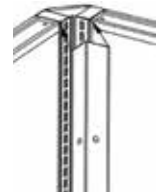

Inside Corner Detail



AA Dressing Room Outside Corner Filler

- Gives clean look to outside corners

DROCF-(NH)

DROCF Dressing Room Outside Corner Filler
 NH Nominal Height 96", 102", 108", 112"
 (2438 mm, 2591 mm, 2743 mm, 2845 mm)
 Blank=Standard 120" (3048 mm)



BB Dressing Room Upright Spacer

- Four required for each outside corner
- Secures two corner uprights

DRUS

DRUS Dressing Room Upright Spacer

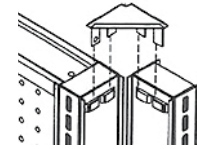

Outside Corner Detail

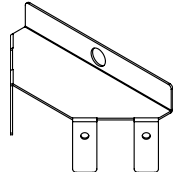

CC Dressing Room Inside Anchor

- Bolts to floor when required

DRIA

DRIA Dressing Room Inside Anchor

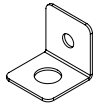

DD Dressing Room Outside Anchor

- Bolts to floor when required

DROA

DROA Dressing Room Outside Anchor

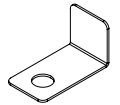

EE Seismic Floor Anchors, Regular-Duty

- For use when local building codes require anchoring Base Shoes and/or standard Uprights to floor
- Level as required prior to anchoring to floor
- Requires two expansion bolts for each order
- Galvanized only

SFA-RD-1

SFA Seismic Floor Anchors
 RD Regular-Duty
 1 1 Pack

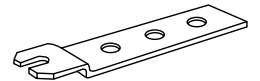

FF Seismic Floor Anchors Expansion Bolts

- ICBO approved
- 3/8"-16 x 3 1/2"
- Order two bolts per Seismic Floor Anchor, regular or heavy-duty

SFA-EB-1

SFA Seismic Floor Anchors
 EB Expansion Bolt
 1 1 Pack

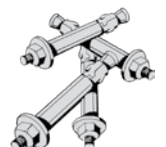

GG Dressing Room Door Panel

- Door is customer supplied

DRDP(NW)

DRDP Dressing Room Door Panel
 NW Nominal Width 48" or 60"
 (1219 mm or 1524 mm)

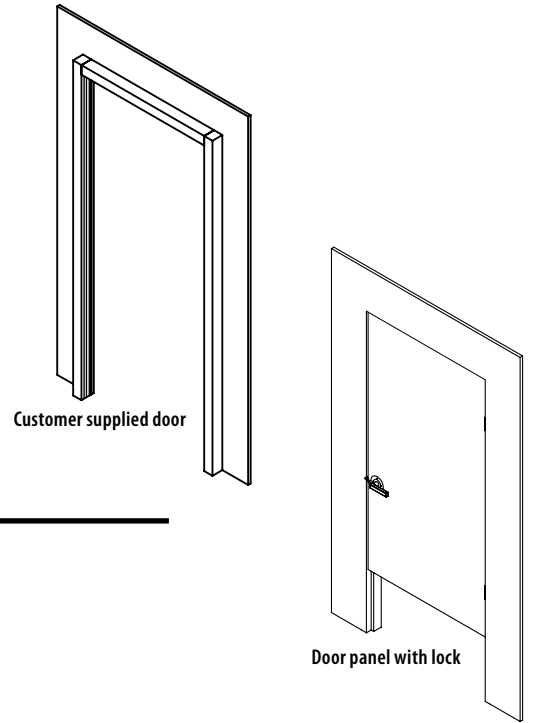

HH Dressing Room Door Panel with Locking Door

DRDPWLD(NW)

DRDP Dressing Room Door Panel
 WLD with Locking Door
 NW Nominal Width 48" or 60"
 (1219 mm or 1524 mm)

HH Dressing Room Door Panel Splicer

- Mounts above dressing room door

DPS-(NW)

DPS Door Panel Splicer
 NW Nominal Width 48" (1219 mm)
 Blank=Standard 60" (1524 mm)

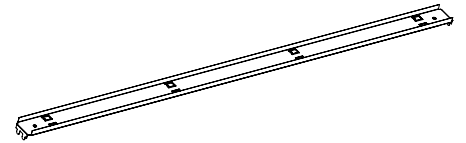

II JJ Dressing Room Door Panel Retainer

- Use when installing double dressing rooms
- Install left- and right-hand retainers into interior of walls

DRDPR-(HAND)

DRDPR Dressing Room Panel Retainer
 HAND LH=Left-Hand
 RH=Right-Hand



KK Dressing Room Divider Panel Stabilizer

- Connects interior walls

DRDPS

DRDPS Dressing Room Divider Panel Stabilizer

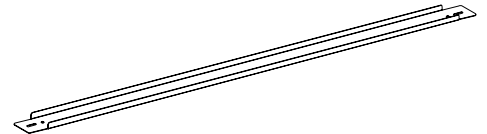

LL Dressing Room Hardware Pack

- Miscellaneous parts required for installation

DR88HP

DR88HP Dressing Room Hardware Pack

Optional Items

Shoe Bench with End Mirrors

- Designed for retail settings that need benches to accommodate customers' shopping needs
- Provides seating and mirrors for customers trying on shoes or clothing
- Can be used in conjunction with T-Rack Shoe Department runs or any setting that requires a seating application
- Load capacity is 500 lbs

SBEM-301718

SBEM Shoe Bench with End Mirrors
 30 Nominal Width 30" (762 mm)
 17 Nominal Depth 17" (432 mm)
 18 Nominal Height 18" (457 mm)

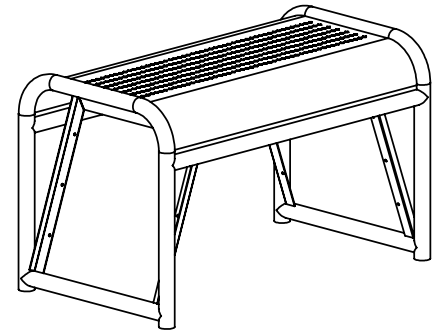

Fitting Room Corner Perforated Bench

- Provide seating in a dressing room without sacrificing floor space
- Can be bolted to floor
- Load capacity is 500 lbs

FRV2SRCB-(NH)

FRV2SR Fitting Room
 CB Corner Perforated Bench
 NH Nominal Height
 Blank=18" (457 mm)
 19=19" (483 mm)

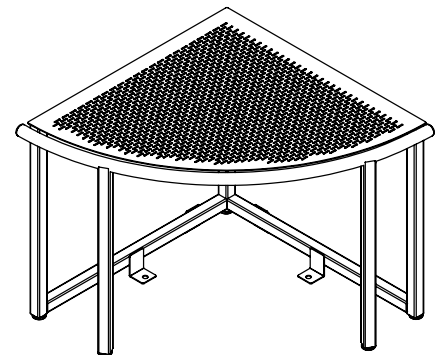

For more dressing-room merchandising accessories, visit www.madixinc.com

For Shared Walls on Maxi Line Dressing Room

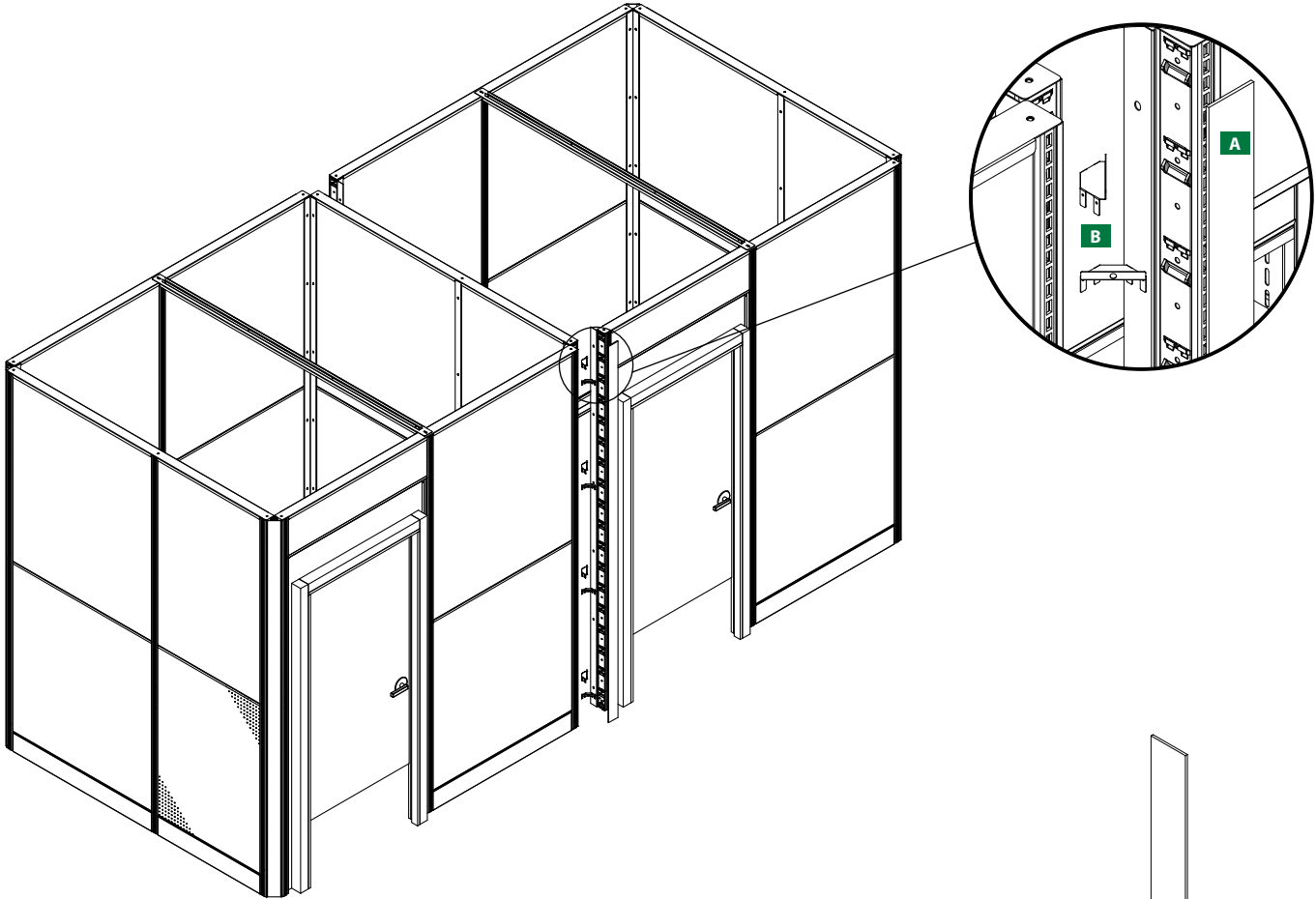

A Dressing Room Outside Filler Panel

- Required to use shared wall
- Use one (1) per wall, two (2) per room

DPOFP05(NH)-(FINISH)

DPOFP Dressing Room Outside Filler Panel
 05 Nominal Width 5" (127 mm)
 NH Nominal Height 54", 90", 96" or 108"
 (1372 mm, 2286 mm, 2438 mm or 2743 mm)
 FINISH HP=Hardboard Painted
 HP2S=Hardboard Painted Two Sides
 HL=Hardboard Laminated
 HL2S=Laminated Two Sides
 PP=Pegboard Painted
 PP2S=Pegboard Painted Two Sides
 MP=Mirror Plex
 VM=Vinyl Mirror



B Dressing Room Upright Spacer

- Required to use shared wall
- Use a minimum of four (4) spacers per wall, eight (8) per room

DRUS

DRUS Dressing Room Upright Spacer

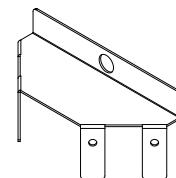

Prices All prices are subject to change without notice. Every effort will be made to give advance notice of any increase through notification from the home office. The customer will receive an acknowledgement showing prevailing prices at the time the order is processed. State or other sales or use taxes, freight and surcharges will be charged when applicable. Freight quotes may be provided based upon information available at time of quote, but are not guaranteed. Active freight charges will be billed if applicable. When market conditions dictate, a surcharge may be implemented. All quotations automatically expire at the end of 30 days.

Terms Cash in advance prior to production or net 30 days if open account status is approved by Madix Credit Department. MasterCard, Visa, and American Express are accepted.

Acceptance All orders, contracts, and agreements are subject to Madix's acceptance and approval. Madix shall not be liable for any delay in the performance of any order, contract, in the delivery of any goods, or for any damages resulting from such delay, when such delay is directly or indirectly caused by or due to fire, flood, accident, riot, act of God, war, governmental decree or order, strike, labor difficulties, shortage of labor, fuel, power, material or supplies, transportation delay or any other delay or causes (whether or not similar to any of those herein before specified) beyond our reasonable control. Order acceptance will be per the conditions and terms outlined in Madix's acknowledgement. Mailing of the acknowledgement will signify Madix's acceptance of the order.

Minimum Charge Orders are subject to a minimum charge of \$50.00 net (merchandise only) per shipping destination.

Changes and Cancellations Customer requested changes and cancellations are subject to approval by Madix. Every reasonable effort will be made to accommodate these requests without additional cost to the customer. Any manufacturing or engineering costs incurred will be charged to the customer. Orders produced and delayed for more than one week may incur charges for demurrage, unloading, or other storage costs. Madix will advise customers of the estimated charges at the time changes or cancellations are made.

Shipments Method and route of shipment are at Madix's discretion unless Madix is furnished with complete shipping instructions at least ten (10) days before the scheduled shipping date. Freight is FOB/EXW Madix shipping point.

Freight Claims For common carrier shipments, claims must be made directly with the carrier by the recipient. Listed are the types of losses which may occur, and your responsibility in handling them:

Loss of Freight: It is the receiver's responsibility to count the freight at the time of delivery. Any exception must be noted on the carrier's delivery receipt at time of delivery.

Damage of Freight: As with a loss of freight, damage of freight must be noted on the carrier's delivery receipt at the time of delivery. It is the receiver's responsibility to make sure that the freight is inspected for visible damage and that the number of pieces damaged is marked on the carrier's delivery receipt. Failure to note visible damage at the time of delivery will result in non-payment of a damage freight claim. Salvage must be held for the carrier.

Concealed Damage: If goods are received in apparently good condition but there is concealed damage, it is the customer's responsibility to contact your Madix Service Representative within 15 calendar days from delivery. Customer must keep the product and the packaging so that an inspection may be conducted by the carrier. Failure to handle a concealed damage claim in this manner could greatly reduce the amount recovered from the carrier.

Returned Goods Returned Goods requests must be submitted to Madix, Inc. within 60 days after receipt of product. Authorization must be in writing on Madix's RGA (Return Goods Authorization) form. Goods must be received within 30 days of RGA issue date for credit. Customer is responsible for delivery of authorized returns to Madix designated location in condition originally received. Only Code A products finished in returnable colors as indicated on the finish policy pages will be considered for return, and only items in unused, in resalable condition, and in the original packaging. No special size, color, or specially manufactured parts or products are eligible for return unless sent to the customer as the result of an error by Madix. Only merchandise listed on the RGA will be accepted for conditional return. Credit will not be issued for that portion of merchandise that is not considered resalable. A handling and restocking charge of 25% of the invoice price will be charged for all approved returns. Submit requests to your Madix Sales Representative or Customer Service Department prior to returning any merchandise. All returns must be have the customer name and Madix RGA number prominently displayed on each package. Product to be shipped prepaid at customer's expense unless prior approval has been received from an authorized Madix Representative.

Warranty We warrant to the original purchaser that all products manufactured by Madix are free from defects in material and workmanship. This warranty is invalid if products or parts are modified or used in a manner other than the intended purpose. Our obligation under this warranty is limited to repairing or replacing of any part or parts which shall, within one (1) year after delivery to the original purchaser, be demonstrated to be defective under normal use and service. This warranty is in lieu of all other warranties, expressed or implied, and of all other obligations or liabilities of any kind on Madix's part, and no modification of this warranty shall be valid or binding unless in writing and signed by an officer of Madix, Inc.

Production Madix fixtures are manufactured utilizing the most current technology of highly automated systems with process control techniques. Skilled craftsmanship, combined with automatic presses, roll forming machines, multi-spot welders, conveyers, finishing equipment and thorough inspections produce store fixtures of the highest quality.

Upright Carefully engineered of heavy gauge, high quality steel components, the UPRIGHT is slotted one inch on center for maximum flexibility, shelf adjustability and use of available space. Standard heights range from 36" through 96" with built-in leveler. For the finishing touch at the end of the shelving run, the snap-on UPRIGHT END COVER is made of durable, scuff and impact resistant plastic or heavy gauge metal. The UPRIGHT CAP, made of high impact plastic, has provision for a sign holder.

Base Shoe The five inch low BASE SHOE features exclusive "I" beam design, engineered of projection welded high strength steel parts insuring maximum load capacity. Snaps securely into upright with leveler and electrical access allowing for quick error free installation. For the finished look, the one piece slip on BASE END COVER is made with a high impact plastic nose reinforcement to protect base shelf tag molding.

Spanners Snap-in support SPANNERS keep uprights at equal spacing and hold the back panels rigid. Each spanner has knockouts for electrical access and telescoping uprights.

Back Panels High density hardboard BACKS fit flush to the face of the upright. A wide variety of finishes include solid, pegboard, wood grain and fabric in a wide assortment of optional colors. Mirrors and open backs are also available.

Kickplate Fully floating feature of kickplate allows flush fit against uneven floors, snaps in and out without disturbing base shelf for easy cleaning. Convenient knockout accommodates electrical access.

Base and Upper Shelves Steel base shelves feature lock tabs to insure quick installation and precision alignment. A double row of 1/4" inch perforations on the front and rear edge makes any form for binning possible. Slim bracket, high tensile design with flat or 15 degree downslope upper shelf positions allow for maximum merchandise visibility. Integrally formed price tag molding accommodates 11/4" tag. Upper shelves available in 8", 10", 12", 14", 16", 20", 22", 24", 26", 28", and 30" depths. Base shelves available in 12", 14", 16", 18", 20", 22" 24", 26", 28" and 30" depths.

Shelf Loading The recommended load capacity for upper shelves is based on evenly distributed weight. Capacities are reduced by 35% when front half is loaded and reflect rated maximum load. Load capacities are shown in the General Information Section under Shelf Loading.

Baked Enamel, Powder Coat Finishes All metal parts are finished with a specially formulated high solids or powder which are electrostatically bonded in a unique multi-stage process, to insure the highest quality finish. Aerosol cans of Touch-up paint are available in Madix's standard and optional colors. FAA regulations prohibit the shipment of this product by air or in export containers by air or ocean to countries outside the United States.

Product Maintenance When necessary to clean Madix shelving, use a non-abrasive mild detergent and warm water, followed by thorough drying. The use of a cloth made of a soft white cotton material is strongly recommended. The use of cleaning products that contain abrasive, bleach, or strong solvents, such as ketones, ethers, etc. will result in damage to the finish. The damage is most severe when these harsh cleaning agents are used on colors which contain leafing aluminum pigment such as powder chrome, silver vein, and other "vein" type finishes. The aluminum in these coatings resides at the surface of the finish and is therefore susceptible to damage by the harsh cleaning agents. As an alternative to the mild detergent, cleaners with ingredients similar to those found in products such as 409, Fantastik, and Simple Green can be used. Caution! Cleaners having ingredients similar to those found in Ajax, Borax, Comet, etc. should be avoided as finish damage could result.

Codes In your planning stage, consult with local municipal engineers to determine what codes and restrictions will be applicable in the locations where the shelving will be used. Codes may include: state, local, fire, building, and health and safety codes. Seismic requirements may apply in some locations. For example, in most locations fire codes state that fixtures need to be at least 18 inches below the sprinklers.

Shelving Selection Take into consideration the load that is expected not only on each shelf but also on the unit as a whole. Take into account the upright capacity. Refer to the load capacity information that is in the Madix Standard Catalog. Madix shelves are rated using an evenly distributed load. Do not install shelves or accessories that extend beyond the depth of the Base Shelves. Consider making the Base Shelves and low height fixtures a contrasting color from the floor's color to prevent potential tripping hazards. Do not use Madix parts or accessories for any purpose other than originally intended by Madix.

Shelving Installation Initial installation or relocation of Madix shelving should be supervised by qualified personnel. Madix products should be installed according to Madix's specifications. Madix's installation sequence must be followed for assembly and leveling. An improperly installed store fixture has a poor appearance and may cause a dangerous condition. Be especially careful when leveling fixtures with offset loads in which one side of the fixture has a considerably heavier load than the other side. Dismantling and reassembling used Madix shelving can be dangerous if the installers who are doing the work leave out parts, use damaged parts, or do not reassemble the product by Madix's specifications. Do not alter, modify, or structurally change any shelving component. Do not move assembled shelving. Only parts and accessories that are produced and supplied by Madix are covered by the Madix warranty. Do not assemble Madix fixtures with parts from other manufacturers. Under no circumstances should you use damaged parts. When assembling Gondola/Wall Shelving, install Kickplates to protect the Base Shoes from floor cleaning equipment and to offset the possible bumping and misalignment of the shelving runs. Do not install shelves or accessories on the sides of wall sections or any section that is not supported by Base Shoes. Use caution when handling and transporting shelving parts. Be careful when cutting shrink wrap from pallets because the shelving parts can dislodge from the wrap and fall. Cut the wrap gradually from the top, only as much as you need to remove the product from the top. Two common hazards while installing store fixtures are: employees hurting themselves with improper types of box cutters and employees putting boxes on the floor and then tripping over them.

Anchoring and Floors Depending on code requirements and Madix's specifications, some products must be anchored to the walls and/or floors. Do not lean tall or heavy objects against unanchored shelving systems. Retailers must consider the type of floor upon which the shelving will be installed.

Impact Loading Impact during the loading and unloading of merchandise can create an adverse loading situation and may result in damage to or failure of the Madix shelving. Do not walk or climb on Madix shelving.

Overturning Overloading the top portion of the shelving, non-uniform loading, out-of-plumb installation, and impact can cause shelving to overturn. Improperly installed Madix shelving with offset loads can cause store fixtures to collapse. Carefully follow Madix's installation instructions in order to prevent shelving from overturning.

Additional Shelving Safety Pointers Product loading instructions are included with each Madix order. Retailers must make merchandisers aware of the product's load limitations and the dangers of overloading the shelving. Remove any merchandise or overstock before attempting to move Madix shelving. Periodically inspect your Madix shelving for damaged or loose parts. Make sure that shelves and accessories are properly seated in the slotting or perforations. Make sure that shelves and accessories are not overloaded. As merchandising changes, beware of creating offset loads on shelving runs that are not properly leveled. Look for leveling warning signs such as increased gaps between shelves or accessories that may indicate that the shelving runs need re-leveling. Damage to Madix shelving is dangerous. In some cases, the shelving should be unloaded immediately and repaired or replaced before returning to service. Re-level fixtures that you have bumped or moved. Incorporate safety into your merchandising strategy. When possible, merchandise the heavier products on the lower shelves. If the merchandise will not fit on the Madix shelves and there is a replenishment cycle, make sure that the cycle is a safe one. Make sure that merchandise and overstock are properly stacked and maintained so that items will not fall into the aisles. Assure that customers who handle merchandise or overstock will not push product from one side of the Madix fixture to the other side where people could be injured from falling merchandise. Safely secure overstock that is placed on Madix shelves overhead. Measure the difficulty that your employees have in retrieving overstock, and consider whether employees or customers could be injured if the product happens to fall from the shelving units. Teach employees and inform customers that Madix shelves should never be used as ladders to reach higher shelves. Ladders should be clearly marked for employees use only and should not be left unattended, or customers will try to remove stock on higher shelves by themselves. Notify customers to ask for assistance when they need product that is out of their reach.

Finish Policy for Metal Products

Standard Colors, Returnable– Code A Madix standard returnable colors for display shelving are Sahara, Blue Gray, Oyster, Snow White, and Satin Black. Madix standard returnable colors for wire products only are Powder Chrome and Silver Vein. All catalog items are priced in standard color.

No Charge Colors (Non-Returnable)– Code B Madix non-returnable colors offered at the standard price are Chocolate, Dove Gray, Dover White, Fashion Gray, Skyline Gray and Tru Gray. All catalog items are priced in standard color.

Optional Colors-Level I Finishes (Non-Returnable)– Code B Madix offers optional colors, also known as Grade I Finishes, at additional charge: Bright Orange, Hollyherry, Hunter Green, Mandarin, Neon Blue, Spectrum Blue, Spectrum Green, Spectrum Red and Valencia. Products painted with these colors are non-returnable.

Metal Components: \$350.00 line charge plus published per-piece charge. **Metal Back panels:** \$350.00 line charge plus published per-piece charge.

Special Colors– Code C Use line change charge plus per piece charge supplied by customer service. Special colors are non-returnable.

Pricing For Levels II To IV:

Level II: 1.6 x Optional Color Upcharge. **Example:** Optional upcharge for SUS is \$1.50; upcharge with Level II finish will be \$2.40.

Level III: 2.8 x Optional Color Upcharge. **Example:** Optional upcharge for SUS is \$1.50; upcharge with Level III finish will be \$4.20.

Level IV: 3.8 x Optional Color Upcharge. **Example:** Optional upcharge for SUS is \$1.50; upcharge with Level IV finish will be \$5.70.

Metal Components: \$500.00 line charge plus published per-piece charge. **Back panels:** \$350.00 line charge plus published per-piece charge.

Maintenance for Metal Products

Baked Enamel and Powder Coated Finishes All metal parts are finished with a specially formulated high solids or powder which are electrostatically bonded in a unique multi-stage process to insure the highest quality finish. Aerosol cans of touch-up paint are available in Madix's standard and optional colors. FAA regulations prohibit the shipment of this product by air or in export containers by air or ocean to countries outside the United States.

Product Maintenance When cleaning Madix shelving, use a non-abrasive mild detergent and warm water, followed by thorough drying. Using a soft white cotton cloth is strongly recommended. Cleaning products containing abrasives, bleach, or strong solvents will result in damage to the finish, especially when used on colors containing leafing aluminum pigment, such as powder chrome or vein-type finishes.

Finish Policy for Wood Products

High Pressure Laminate The terms "laminates" or "HPL" are commonly applied to this material which consists of multiple layers of paper infused with phenolic resin and topped by a finish paper coated with clear melamine resin, all totally bonded under high pressure and heat. The finished sheet has extremely high wear and impact resistance.

Customer Specified High Pressure Laminate Madix coding is based on Wilsonart availability. Laminates other than Wilsonart may require additional lead time.

- Customer specified laminates add \$100.00 per pattern, per order
- Additional charge will apply based on the laminate grade that is chosen

Laminates that are not from a laminate manufacturer's standard samples (metallics, heavy textures, wet looks, core edge, special prints) will require a special quote. Contact Customer Service for specific pricing on laminates not listed above.

Thermofused Panels Thermofused panels are ideal for non-wear surfaces and have substantial impact and wear characteristics compared to melamine panels previously available. The product is produced using hot press laminating polyester or melamine resin impregnated self-bonding paper to wood substrate. Performance specifications are available from the American Laminations Association. Madix does not recommend the use of Thermofused panels on horizontal or other wear surfaces.

Printed Mirror Hardboard Printed materials are primarily used for back panels, but appear as various other products. These materials are carefully cross matched to the corresponding laminates and Thermofused. Mylar mirror hardboard is used in the same applications and is also available in pegboard and grooved pegboard. **Finish Policy for Back Panels**

Standard Colors, Returnable– Code A Madix standard returnable colors for display shelving back panels are Sahara, Oyster, and Snow White.

Optional Colors-Level I Finishes (Non-Returnable)– Code B Madix non-returnable back panel colors offered at the optional price are Chocolate, Dove Gray, Dover White, Fashion Gray, Satin Black, Skyline Gray, Blue Gray and Tru Gray. Set-up charge of \$350.00 applies.

Optional Colors-Level II Finishes (Non-Brilliant)– Code B Madix offers optional back panel colors also known as non-brilliant finishes at an additional charge. These colors include custom grays, off whites, tans, and beiges not listed in Madix's Finishes brochure. Products painted with these colors are non-returnable. Set-up charge of \$350.00 applies.

Optional Colors-Level III Finishes (Brilliant)– Code C Brilliant back panel finishes include Hunter Green, Neon Blue, Spectrum Blue, and Spectrum Green. Set-up charge of \$350.00 applies.

Optional Colors-Level IV Finishes (Reds and Yellows)– Code C Use line change charge plus per piece charge supplied by customer service. Special colors are non-returnable. Set-up charge of \$350.00 applies.

Pricing For Levels II To IV

Level II 1.2 x the difference between the Hardboard/Pegboard Optional Color pricing and the Hardboard/Pegboard Sahara pricing. **Example:** Optional upcharge for a BH-342 with a Level II finish would be calculated as follows: $\$13.85 - \$12.45 = \$1.40 \times 1.2 = \1.68 . The color upcharge for a BH-342 with a Level II finish is \$1.68. This upcharge amount will be added to the Optional Color price of a BH-342. The new price of a BH-342 using a Level II finish is $\$15.53$ ($\$13.85 + \$1.68 = \$15.53$).

Level III 1.4 x the difference between the Hardboard/Pegboard Optional Color pricing and the Hardboard/Pegboard Sahara pricing. **Example:** Optional upcharge for a BH-342 with a Level III finish would be calculated as follows: $\$13.85 - \$12.45 = \$1.40 \times 1.4 = \1.96 . The new color upcharge for a BH-342 with a Level III finish is \$1.96. This upcharge amount will be added to the Optional Color price of a BH-342. The new price of a BH-342 using a Level III finish is $\$15.81$ ($\$13.85 + \$1.96 = \$15.81$).

Level IV 1.8 x the difference between the Hardboard/Pegboard Optional Color pricing and the Hardboard/Pegboard Sahara pricing. **Example:** Optional upcharge for a BH-342 with a Level IV finish would be calculated as follows: $\$13.85 - \$12.45 = \$1.40 \times 1.8 = \2.52 . The color upcharge for a BH-342 with a Level IV finish is \$2.52. This upcharge amount will be added to the Optional Color price of a BH-342. The new price of a BH-342 using a Level IV finish is $\$16.37$ ($\$13.85 + \$2.52 = \$16.37$).

NOTE! See Finishes Brochure for color samples.

Part Name	Part Number	Page Number
B		
Back Panel	B(TYPE)-(NW)(NH)	20
Back, Extension	BX(TYPE)-(NW)(NH)	20
Basic Upright	BU-(NH)	19
D		
Dressing Room Corner Crossbar	DRCCB	20
Dressing Room Divider Panel Stabilizer	DRDPS	22
Dressing Room Door Panel	DRDP(NW)	22
Dressing Room Door Panel Retainer	DRDPR-(HAND)	22
Dressing Room Door Panel Splicer	DPS-(NW)	22
Dressing Room Door Panel with Locking Door	DRDPWLD(NW)	22
Dressing Room Hardware Pack	DR88HP	22
Dressing Room Inside Anchor	DRIA	21
Dressing Room Inside Corner Filler	DRICF-(NH)	21
Dressing Room Outside Anchor	DROA	21
Dressing Room Outside Corner Filler	DROCF-(NH)	21
Dressing Room Outside Filler Panel	DPS05(NH)-(FINISH)	24
Dressing Room Top Rail Stabilize	DRTRS	20
Dressing Room Upright Face Cover	DRUFC-(NH)	21
Dressing Room Upright Spacer	DRUS	21, 24
E		
Extension Upright	EU-(NH)	19
F		
Fitting Room ADA Bench Modified	FRV2HRBM-(NW)(19)(ND)	15
Fitting Room Clothes Hanger	FRV2CH	15
Fitting Room Corner Perforated Bench	FRV2SRCB-(NH)	23
Fitting Room Grab Rail, 36"	FRV2GR	15
Fitting Room Hardware Pack	FRV2HWP	9, 14
Fitting Room Metal Framed Mirror	FRMF	16
Fitting Room Metal Framed Mirror	FRMF54225	16
Fitting Room Metal Framed Single Corner Mirror	FRMF54225	16
Fitting Room Outside Tube Mount	FRV20TM(NH)	9
Fitting Room Outside Upright Assembly	FRV2U(OPT)(NH)	8, 13
Fitting Room Panel Door Assembly	FRV2PD3648(NH)(HAND)	9, 13
Fitting Room Standard Room Corner Bench	FRV2SRCB-19NP	15
Fitting Room Upright for Outside Merchandising	FRV2UOM(OPT1)(OPT2)(NH)	8
Fitting Room Upright Wall Attachment	FRV2U(NH)WA	14
Fitting Room Wall Alignment Brace	FRV2WAB664818	9
Fitting Room Wall Mount Brace, 60"	FRV2WMB60	14
Fitting Room Wall Panel Assembly	FRV2P(NW)(NH)	8, 13
L		
Lower Spanner	SL-(NW)	19
M		
Maxi Line Dressing Room		17
Metal Back Panels	MBP-(NW)(NH)	20
Metal Back Panels, Non-Perforated	MBP-(NW)(NH)-NP	20
Metal Extension Back Panel	MEBP-(NW)(NH)-(OPT)	20
O		
Open Back Stiffener	OBS-(NW)	19
Open Back Stiffener Kickplate	OBSKP-(NW)	19
S		
Seismic Floor Anchors Expansion Bolts	SFA-EB-1	21
Seismic Floor Anchors, Regular-Duty	SFA-RD-1	21
Shoe Bench with End Mirrors	SBEM-301718	23
Splicer Spanner	SS-(NW)	19
T		
T-Leg Straight-In Locking, Spring Loaded	TLEGSILSL(ND)-(OPT)	20
TL Cap for T-Leg	TLUCP	20
Top Spanner	STL-(NW)	19
Tube Line ADA Standard Wall Mount Fitting Room – Add-On		12
Tube Line ADA Standard Wall Mount Fitting Room – Starter		12
Tube Line Fitting Room		3
Tube Line Freestanding ADA Fitting Room – Add-On		7
Tube Line Freestanding ADA Fitting Room – Starter		7
Tube Line Freestanding Standard Fitting Room – Add-On		6
Tube Line Freestanding Standard Fitting Room – Starter		6
Tube Line Freestanding Three Bay Fitting Room		5
Tube Line Freestanding Two Bay Fitting Room		4
Tube Line Standard Wall Mount Fitting Room – Add-On		11
Tube Line Standard Wall Mount Fitting Room – Starter		11
Tube Line Wall Mount Two Bay Fitting Room		10

@FRONT

ROLLER-SHELF SYSTEM
FOR HEAVY-DUTY

THE SHELF THAT SORTS ITSELF



REPLACES CUMBERSOME,
SPRING PUSHER SYSTEMS

ALSO GREAT FOR:

Retail

Refrigeration



Innovation on Display Since 1956



www.madixinc.com

Texas 500 Airport Road, Terrell, TX 75160 | 1010 S. Bolton, Jacksonville, TX 75766
Alabama 20984 Alabama Hwy. 9, Goodwater, AL 35072 | 500 Madix Drive, Eclectic, AL 36024